 Refer to safety information on page 1 & 2.

Coiled Air Brake Tube Assemblies



Conforms to SAE J844 Type B and SAE J1131.
 Conforms to DOT FMVSS 571.106.
 Maximum Working Pressure 150 PSI. Minimum Burst: 950 PSI.
 Temperature Range -40°F to +200°F.
 Brass end fittings with spring guards and 1/2" male pipe connections.
 Spring guards zinc plated for maximum corrosion resistance.
 Color coding, red for emergency and blue for service, provides you with error free installation.
 Preassembled for immediate installation.

| Catalog Number | Tube O.D. | Male Pipe | Working Length | Pigtail Length |
|----------------|-----------|-----------|----------------|----------------|
| W1206* | 1/2 | 1/2 | 12' | 6" |
| W1212* | 1/2 | 1/2 | 12' | 12" |
| W1512* | 1/2 | 1/2 | 15' | 12" |

*Each catalog number contains a coiled red assembly and a coiled blue assembly.

Gladhand Couplings

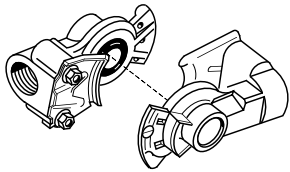

- Die cast aluminum body
- Conforms to SAE J318
- Connects to 1/2" pipe
- Includes seal

Catalog Number

- W79850 SERVICE (Signal) (Blue clip; Connects only to service)
- W79851 EMERGENCY (Supply line) (Red clip; Connects only to emergency)
- W76150 UNIVERSAL (Connects to all three styles)

Gladhand Seal

For use with W79850, W79851, W76150.



Catalog Number

W14630

 Refer to safety information on page 1 & 2.

Vernier Controls

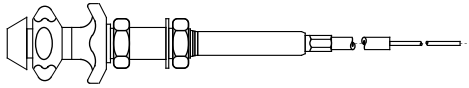

Catalog Number: 8374

New advanced styling. Meets or exceeds OEM specifications. Non-Corrosive aircraft aluminum body and stainless steel shaft assures 400 hour salt spray test without corrosion.

A direct replacement for most "Remote Throttle Controls"; Mack Truck 21QB-180 Series, Kenworth K068B Series, Peterbilt 05-1462 Series, Volvo-White 13401 Series, I.H. 34084 Series, Muncie COCL Series BPC VCG Series. Also replaces most Garage and Service Station Wreckers remote control throttles; Earnest Holmes, Dover, etc.

Turn-To-Lock Controls (T-Locking)

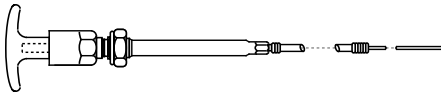

Catalog Numbers: 8370, 8371

New positive action control for small to mid-size engine throttles, governors, chokes, fuel shut-offs and more.

Aluminum body assures rust free performance. Patented Acetal Locking bushing guarantees never before possible settings with one third operator effort. Replaces Muncie COCL Series, and BPC R09 Series.

Power Take Off Controls (Ball Knob)

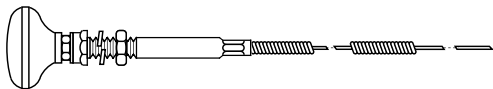

Catalog Numbers: 8372, 8373

Utility grade as exact replacement for most P.T.O. Controls.

Features 2" Round Knobs, Galvanized Steel, vinyl covered casing and steel inner wire. All P.T.O. Controls meet or exceed OEM specifications. Replaces BPC R-38DS, R04, R38 and R38D Series, Muncie COKB Series.

 Refer to safety information on page 1 & 2.

Utility Light Load Controls (Dash)

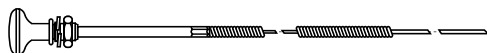

Catalog Numbers: 8375, 8376, 8377, 8378

Universal light load Choke, Fuel-Shutoff, Throttle, Hood, Trunk and more! Controls are designed for most engine applications. Stainless steel inner-wire resists corrosion and assures trouble free operation. Vinyl coated.

Throttle Stop



Catalog Number

1548

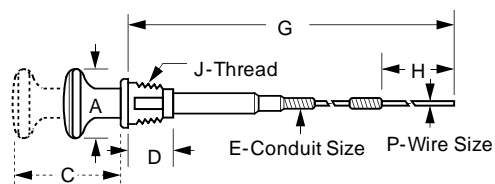

SPECIFICATION CHART ON WEATHERHEAD "PUSH-PULL" CONTROLS

| Description | Dash | | | | T-Hood | T-Locking | | PTO Control | | Vernier | Deluxe PTO Control | |
|--------------------------|------------------|----------|--------|-------|-------------------|------------------|------------------|------------------|------------------|-----------------------------|--------------------|--------|
| | 8375 | 8376 | 8377 | 8378 | 8367 | 8370 | 8371 | 8372 | 8373 | 8374 | 106370 | 106470 |
| Catalog Number | 8375 | 8376 | 8377 | 8378 | 8367 | 8370 | 8371 | 8372 | 8373 | 8374 | 106370 | 106470 |
| Length of "G" | 84" | 84" | 84" | 60" | 180" | 126" | 186" | 81" | 165" | 120" | 192" | 300" |
| Length of Wire "H" | 9-3/8" | 9-3/8" | 9-3/8" | 7" | 5" | 6" | 6" | 3" | 3" | 4-1/2" | 12" | 12" |
| Knob Type | Round | | | | T-Handle | T-Handle | | Round | | Round | Round | |
| Knob Size "A" | 1.06" | | | | 2" | 2" | | 2" | | 2" | 2" | |
| Knob Color | Black | | | | Chrome | Chrome | | Black | | Black | Red | |
| Knob Material | Plastic | | | | Cast Zinc | Nylon | | Plastic | | Plastic | Plastic | |
| Knob Lettering | Choke | Throttle | None | None | None | Lock | | None | | None | None | |
| Knob Travel "C" | 2-1/2" | | | | 2-1/2" | 3" | | 3-1/2" | | 3-3/8" | 4-1/2" | |
| Thread Size "J" | 3/8"-24 | | | | 3/8"-24 | 7/16"-20 | | 7/16"-20 | | 3/4"-16 | 1/2"-20 | |
| Thread Length "D" | 1/2" | | | | 1/2" | 3/4" | | 1-5/32" | | 2-1/2" | 1-1/8" | |
| Conduit Size "E" | 3/16" | | | | 3/16" | 3/16" | | 1/4" | | 1/4" | 3/8" | |
| Conduit Material & Style | Galvanized Steel | | | | Steel Vinyl Cover | Galvanized Steel | Galvanized Steel | Galvanized Steel | Galvanized Steel | Galvanized Steel | High Carbon | |
| | Vinyl | Vinyl | Vinyl | Vinyl | | Vinyl Covered | Vinyl Covered | Vinyl Covered | Vinyl Covered | Polyethylene Lining & Cover | | |
| Wire Size "P" | .054" | | | | .054" | .054" | | .088" | | .0625" | .088" | |

RELATED PROD

 Refer to safety information on page 1 & 2.



T-570-1 • Ermeto-Quick Set™ Preset Machine

The Ermeto-Quick Set Machine is ideal for bulk assemblies. It has a positive-stop action, which guarantees uniform repeatability, and a hand pump operation which yields quick cycle time, reducing assembly time. The T-570 is an easy tool to use that will save you time and money.

T-570 Package includes:

| | | | |
|-----------------|--------------------------------|-----------------|--------------|
| T-460-2 | Hand Pump (10,000 PSI) | | |
| T-450-3 | Quick Disconnect Hose Assembly | | |
| T-570-1 | Ermeto® Preset Machine | | |
| T-570-4 | Preset Die | T-571-4 | Tube Support |
| T-570-6 | Preset Die | T-571-6 | Tube Support |
| T-570-8 | Preset Die | T-571-8 | Tube Support |
| T-570-12 | Preset Die | T-571-12 | Tube Support |
| T-570-16 | Preset Die | T-571-16 | Tube Support |

-20, -24, and -32 sizes also available.



Metric Flareless Hand Presetting Tools

Presetting tools provide a more accurate and positive leak-proof method of coupling flareless fittings. Presetting the steel metric sleeves prior to fitting assembly will permit the maximum high performance obtainable with flareless fittings. These tools are available for both the Light (DIN 3901/3902L) and Heavy (DIN 3901/3902S) flareless series.

| Light Series 3901/3902L | | | Heavy Series 3901/3902S | | |
|-------------------------|----------------|-------------|-------------------------|----------------|-------------|
| Catalog Number | Tube O.D. (mm) | Thread Size | Catalog Number | Tube O.D. (mm) | Thread Size |
| TL7008 | 8 | M14x1.5 | TH7008 | 8 | M16x1.5 |
| TL7010 | 10 | M16x1.5 | TH7010 | 10 | M18x1.5 |
| TL7012 | 12 | M18x1.5 | TH7012 | 12 | M20x1.5 |
| TL7015 | 15 | M22x1.5 | TH7014 | 14 | M22x1.5 |
| TL7018 | 18 | M26x1.5 | TH7016 | 16 | M24x1.5 |
| TL7022 | 22 | M30x2.0 | TH7020 | 20 | M30x2.0 |
| TL7028 | 28 | M36x2.0 | TH7025 | 25 | M36x2.0 |
| | | | TH7030 | 30 | M42x2.0 |



Ermeto® Hand Presetting Tools 7000 Series

Presetting tools provide a more accurate and positive leak-proof method of coupling flareless fittings. Presetting steel Ermeto® sleeves on tubing prior to fitting assembly will permit the maximum high performance obtainable with flareless fittings. Due to possible thread galling, the use of presetting tools is required when assembling stainless steel fittings.

| Catalog Number | Tube O.D. (Inches) | Thread Size | Catalog Number | Tube O.D. (Inches) | Thread Size |
|------------------------|--------------------|-------------|------------------------|--------------------|-------------|
| T-7002 | 1/8 | 5/16-24 | T-7012 | 3/4 | 1-1/16-12 |
| T-7003 | 3/16 | 3/8-24 | T-7014 | 7/8 | 1-3/16-12 |
| T-7004 | 1/4 | 7/16-20 | T-7016 | 1 | 1-5/16-12 |
| T-7005 | 5/16 | 1/2-20 | T-7020 | 1-1/4 | 1-5/8-12 |
| T-7006 | 3/8 | 9/16-18 | T-7024 | 1-1/2 | 1-7/8-12 |
| T-7008 | 1/2 | 3/4-16 | T-7032 | 2 | 2-1/2-12 |
| T-7010 | 5/8 | 7/8-14 | | | |

 Refer to safety information on page 1 & 2.



SAE Straight Thread O-Ring Boss Tapping and Counterboring Tools

These Weatherhead precision counterborer and tap tools are available in the full range of sizes. They provide the correct SAE contour and UNF-2B threads for proper containment of Weatherhead Flareless '7000' Series Ermeto® and Weatherhead Flare-Twin® straight-thread o-ring tube fittings.

| Thread Tap Catalog No. | UNF-2B Thread Size of Thread Tap | Drill Size | For Fitting Size | For Tube O.D. | Counter-Borer Catalog No. |
|------------------------|----------------------------------|------------|------------------|---------------|---------------------------|
| T-5002 | 5/16-24 | I | 2 | 1/8 | T-5102 |
| T-5003 | 3/8-24 | O | 3 | 3/16 | T-5103 |
| T-5004 | 7/16-20 | W | 4 | 1/4 | T-5104 |
| T-5005 | 1/2-20 | 29/64 | 5 | 5/16 | T-5105 |
| T-5006 | 9/16-18 | 1/2 | 6 | 3/8 | T-5106 |
| T-5008 | 3/4-16 | 11/16 | 8 | 1/2 | T-5108 |
| T-5010 | 7/8-14 | 51/64 | 10 | 5/8 | T-5110 |
| T-5012 | 1-1/16-12 | 31/32 | 12 | 3/4 | T-5112 |
| T-5014 | 1-3/16-12 | 1-3/32 | 14 | 7/8 | T-5114 |
| T-5016 | 1-5/16-12 | 1-7/32 | 16 | 1 | T-5116 |
| T-5020 | 1-5/8-12 | 1-17/32 | 20 | 1 1/4 | T-5120 |
| T-5024 | 1-7/8-12 | 1-25/32 | 24 | 1 1/2 | T-5124 |
| T-5032* | 2-1/2-12 | 2-27/64 | 32 | 2 | T-5132* |

*Special order only.



RG-24 • Hydraulic O-Ring Assortment

Weatherhead's RG-24 is your solution to storing a useful inventory of hydraulic o-rings. This kit contains o-rings for Weatherhead's straight thread and FOR-SEAL® tube fitting applications as well as popular (code 61) split flange hydraulic applications. The RG-24 comes enclosed in a handy steel case with a carrying handle. Consider an RG-24 for an over-the-counter sales merchandiser or keep one in your equipment shop or maintenance trailer to prepare for those critical "got-to-have-it" applications.

Twenty-four individual compartments keep your hydraulic o-ring inventory separated by part number, and labelled illustrations on the inside of the assortment prevent the mix-up of o-rings. Compact, organized and reasonably priced, if you specialize in hydraulic applications which call for o-rings – we've got your number – RG-24.

RG-24 • O-Ring Assortment Contents

| Part Number | Split Flange Quantity | Part Number | FOR-SEAL® Quantity | Part Number | Straight Thr. Quantity |
|-------------|-----------------------|-------------|--------------------|-------------|------------------------|
| 8x252 | 12 | 4629x4 | 12 | 7629x4 | 12 |
| 12x252 | 12 | 4629x6 | 12 | 7629x5 | 12 |
| 16x252 | 12 | 4629x8 | 12 | 7629x6 | 12 |
| 20x252 | 12 | 4629x10 | 12 | 7629x8 | 12 |
| 24x252 | 12 | 4629x12 | 12 | 7629x10 | 12 |
| 32x252 | 12 | 4629x16 | 12 | 7629x12 | 12 |
| | | 4629x20 | 12 | 7629x16 | 12 |
| | | 4629x24 | 12 | 7629x20 | 12 |
| | | | | 7629x24 | 12 |
| | | | | 7629x32 | 12 |

O-rings conform to SAE J515 Type CH.

 Refer to safety information on page 1 & 2.



TA-1002 • Thread Measuring Kit

Measuring tube and pipe fitting threads can be a most difficult task if not completely understood. Tools needed include a thread pitch gauge, calipers and seat angle gauges. To aid you, Weatherhead has a kit to fit your needs, the TA-1002 thread measuring kit.

This handy kit includes:

- Thread Pitch Gauge (American and metric)
- Inside/Outside Caliper (inches and millimeters)
- 2 Seat Angle Gauges (37°/45° and a 12°/30°)
- 24-Page International Measuring and Identification Guide and Instruction Booklet
- Carrying Case for Easy and Convenient Storage



TA-1004 • Metric Thread Identification Kit

Contained in a durable steel carrying case, TA-1004 will help you with identification of metric, British pipe and JIS thread configurations. Identification pieces are configured for 20 metric and 8 British pipe sizes, an increase of three metric sizes compared to the TA-1003.

This handy kit includes:

- Steel Carrying Case
- Stainless Steel Caliper
- Metric and British Thread Pitch Gauges
- British Thread Measuring Templates (4 measuring 8 sizes) made of durable aircraft grade aluminum.
- Metric Thread Measuring Templates (10 measuring 20 sizes) made of durable aircraft grade aluminum.
- Kit Content Identification Chart

 Refer to safety information on page 1 & 2.



Rapid Wrenches

The Rapid Wrench is a heavy-duty, high quality wrench that ratchets for quick installation and removal of tube fittings and hose ends. These wrenches have jaws that snap open and close completely around the fitting giving 6-point contact. Needing only 30° of rotation to ratchet, they allow easy access to tight locations. Available individually or in a set with pouch, these wrenches are a welcome addition to any tool box.

- T-139** 7-Piece Set with Pouch (1/2" through 7/8")
- T-139P** Pouch for 7-Piece Set
- T-152** 11-Piece Set with Pouch
- T-152P** Pouch for 11-Piece Set

| Catalog Number | Wrench Hex Size | Catalog Number | Wrench Hex Size |
|----------------|-----------------|----------------|-----------------|
| T-140 | 3/8" | T-145 | 11/16" |
| T-141 | 7/16" | T-146 | 3/4" |
| T-142 | 1/2" | T-147 | 13/16" |
| T-143 | 9/16" | T-148 | 7/8" |
| T-144 | 5/8" | T-149 | 15/16" |
| | | T-151 | 1" |



T-150 • Utility Tube Cutter

Need to cut stainless steel tubing? This cutting tool is for you. It features an enclosed feed screw to eliminate clogging and jamming. Grooved rolls for close to flare cuts and a fold away reamer.

Capacity: 1/8" to 1-1/8" O.D. Cuts hard and soft copper, aluminum, brass, carbon steel and stainless steel tubing.

Spare Parts: **T-1422R** Replacement Cutting Wheel

 **CAUTION:** Sharp blade! Keep hands and fingers away from cutting surface!



T-1430 • Inner-Outer Reamer

Reams both inside and outside edges of tube with three hollow ground tool steel cutters. Fluted body is shaped to fit comfortably in palm of hand.

Capacity: 3/16" to 1-1/2" O.D. Reams copper, brass, aluminum and other tubing.

 **CAUTION:** Sharp blade! Keep hands and fingers away from cutting surface!

 Refer to safety information on page 1 & 2.



T-1037 • Knife

An inexpensive, reliable knife useful in splitting twin-line hoses quickly and easily.

Replacement Blade: [T-1037B](#)

Replacement Handle: [T-1037H](#)



T-135 • Plastic Tube and Hose Cutter

An economical alternative to quality tube and hose cutting. This versatile tool is lightweight and durable for long service life.

Replacement Blade: [T-135B](#)

Replacement Blade for T-125: [T-125B](#)

Capacity: Up to 1" hose I.D.

NOTE: Not for use with wire-reinforced hose.



T-138 • Hose and Tube Cutter

One hand operation for quick, clean cuts through plastic or nylon compound tubing and solid or fiber-reinforced hose up to 1-1/2" O.D.

- Any wireless hose or tubing.
- Power steering hose (H324)
- Air Conditioning hose (H757)
- Air brake hose (H338)
- Air system nylon tubing (NT100)
- Thermoplastic hose (H435, H436, H335, and H336)
- Low pressure plastic tubing (PT200, PT230, PT240)

Replacement Blade: [T-138B](#)

NOTE: Not for use with wire-reinforced hose.



T-191 • Plastic Tube and Hose Cutter

A tool designed to be small, only 2-7/8" long. The versatile Weatherhead T-191 offers quick and clean square cuts on 1/16" to 1/2" O.D. plastic tubing and non-wire reinforced hose. The T-191 can be either bench or wall mounted and offers the safety of closing automatically when not in use.

Spare Parts: [T-191B](#) Replacement Blade (one per package)

 Refer to safety information on page 1 & 2.

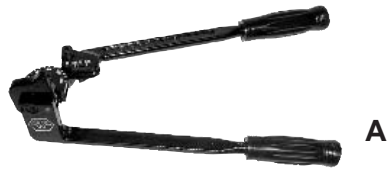

A



B



C

LEVER TYPE TUBE BENDERS

Each tool bends one size. Openside type. Handy in a tight spot. Makes precision short radius bends up to 180° with minimum effort. Keeps tube round, no marks or scrapes, shows bend degree. Unique extra strong hook grips tubing securely.

| Catalog Number | Tubing (O.D.) | Nominal Size | Radius to Center of Tube | Weight Each | Type |
|----------------|---------------|--------------|--------------------------|----------------|------|
| T-372 | 1/8 | — | 3/8 | 8 ozs. | A |
| T-373 | 3/16 | — | 7/16 | 9 ozs. | A |
| T-374 | 1/4 | 1/8 | 9/16 | 12 ozs. | B |
| T-375 | 5/16 | — | 11/16 | 1 lb. 4 ozs. | B |
| T-376 | 3/8 | — | 15/16 | 1 lb. 12 ozs. | B |
| T-378 | 1/2 | 3/8 | 1-1/2 | 3 lb. 8 ozs. | B |
| T-3710* | 5/8 | 1/2 | 2-1/4 | 10 lbs. | C |
| T-3712* | 3/4 | 5/8 | 3 | 10 lbs. 8 ozs. | C |
| T-3716* | 1 | — | 3-1/2 | 10 lbs. 8 ozs. | C |

* Will bend annealed copper and aluminum tubing only.

Capacity: Individual tools for bending eight sizes from 1/8" to 3/4" O.D. tubing. Will bend annealed copper, annealed-steel (inc. JIC), stainless steel and all soft tubing.



SPRING TUBE BENDERS

Low cost, tube bending spring operates perfectly in hand bending copper, aluminum and other thin-walled tubing. Bends are true with minimum tubewall collapsing. Belled at one end to facilitate removal. Bright-plated spring wire finish.

| Catalog Number | Tubing (O.D.) (Inches) | Length (Inches) | Weight |
|----------------|------------------------|-----------------|------------|
| T-104 | 1/4 | 10 | 4 ozs. |
| T-105 | 5/16 | 10 | 4 ozs. |
| T-106 | 3/8 | 10 | 5 ozs. |
| T-107 | 7/16 | 12 | 7 ozs. |
| T-108 | 1/2 | 12 | 8 ozs. |
| T-1010 | 5/8 | 12 | 10 ozs. |
| SETS | | | |
| T-100 | 1/4, 3/8, 1/2, 5/8 | 10 & 12 | 1-1/2 lbs. |
| T-200 | 1/4, 5/16, 3/8, 1/2 | 10 & 12 | 1-1/4 lbs. |

 Refer to safety information on page 1 & 2.



T-345K • Tube Cutting and Flaring Kit

Tube flaring and cutting has just become a little easier with the convenient T-345K Tube Flaring and Cutting Kit.

This kit features a quality-made Double Flaring Tool offering accurate single flares between 3/16" and 5/8" O.D. tubing. Double flares between 3/16" and 2/2" O.D. tubing. Check these features:

- Hardened, smooth cone for fast, accurate 45° flares.
- Single and double flare capability.
- Clamp screw for easy clamping and removal of tubes.
- Flaring Bar installed from either side of yoke.
- Flares soft copper, brass, aluminum and mild steel (JIC and Bundy) tubing.

T-345K Components can be ordered separately:

T-345 45° Flaring Tool, Double Flare Adapters and Plastic Box

T-150 1/8" to 1-1/8" Tube Cutter

T-1422R T-150 Spare Cutting Wheel

Double Flare Adapters:

| Catalog Number | Tube O.D. |
|----------------|-----------|
| T-346x3 | 3/16" |
| T-346x4 | 1/4" |
| T-346x5 | 5/16" |
| T-346x6 | 3/8" |
| T-346x8 | 1/2" |

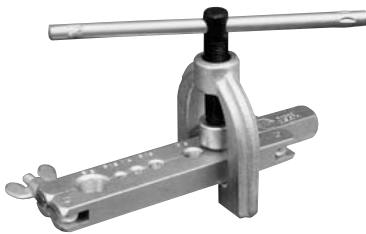

T-1022 • Flaring Tool (45°)

Economical, fast operating tool. Quick slip-on aluminum alloy yoke. Easy operating, swivel-type, hard chrome finished cone assures smooth flares.

Yoke slips down over top of bar and locks into position with a single turn.

Flaring Capacity: 3/16", 1/4", 5/16", 3/8", 7/16", 1/2", and 5/8" O.D. Forms 45° flares in soft copper, aluminum and brass.

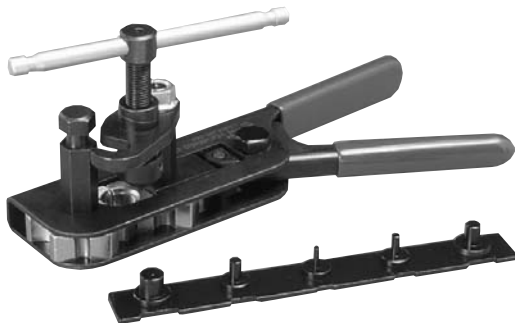

T-220 • Double Flaring Tool (45°)

This new style tool makes single or double flaring easier and quicker than ever. Cam action provides positive, non-slip grip on the tubing with just a squeeze of the handle. Double flaring bar also serves as gauge for correct tubing height to insure perfect flares.

Flaring Capacity: 3/16", 1/4", 5/16", 3/8", 1/2" and 5/8" O.D. for single flares, and up to 1/2" O.D. for double flares. Can be used with copper, aluminum, brass, bundyweld and steel tubing.

Weight: 2 lbs.

T-220 Components can be ordered separately

T-210 Tool for single flaring only

T-221 Double Flaring Bar only.

Flaring Capacity: 3/16", 1/4", 5/16", 3/8" and 1/2"



T-1290 • Segmented Flaring Tool (37°)

Hard chrome finished cone makes exceptionally smooth flares and minimizes amount of effort needed. Forged steel yoke for maximum strength. Sliding die blocks lock in place by lever clamp action.

Flaring Capacity: 3/16", 1/4", 5/16", 3/8", 1/2" and 5/8" O.D. Forms 37° SAE flares in soft copper, aluminum, brass and bundyweld tubing.

Weight: 1 lb., 11 oz.

 Refer to safety information on page 1 & 2.

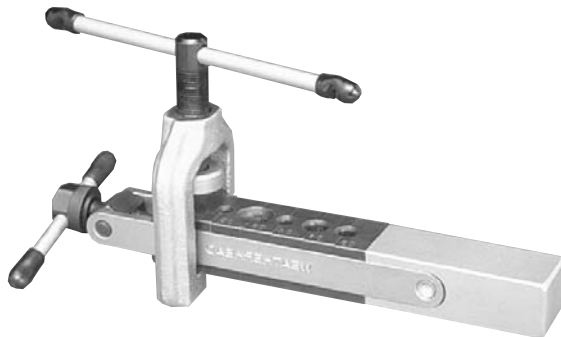

T-1295 • Heavy-Duty Segmented Flaring Tool (37°)

Ideal for use where considerable number of 37° flares in stainless steel tubing must be made. Built to withstand continuous rugged service. Ball thrust mechanism reduces effort required. Hardened tool steel die features non-slip grip of tubing – even after repetitive flaring. Bar has vise extension.

Flaring Capacity: 1/8", 3/16", 1/4", 5/16", 3/8", and 1/2", O.D. tubing. Forms 37° SAE flares in annealed stainless steel (MIL-T-6845 or AMS-5566), cold drawn stainless steel, and annealed copper, brass, steel or aluminum.

Weight: 3 lbs.

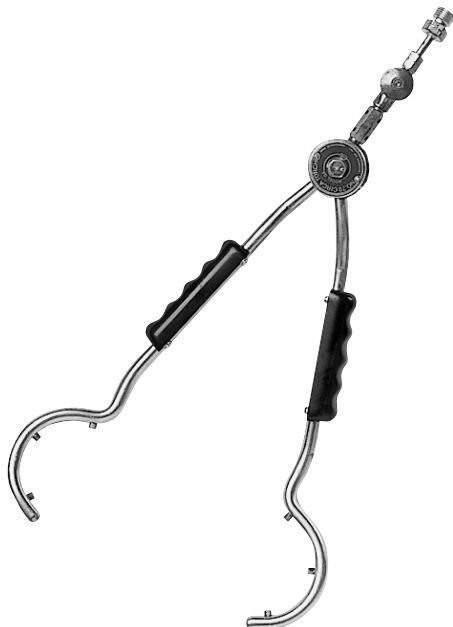

T-562 • Circa Torch

This braze tool from Weatherhead provides an excellent way to braze FOR-SEAL® fittings. Heat is evenly distributed among six flame ports creating a fast, convenient way to make tube assemblies.

 **WARNING:** Torch only to be used with acetylene!

 **WARNING:** Must be used in a well ventilated area!

 Refer to safety information on page 1 & 2.



 **WARNING:** Must be used in a well ventilated area!

T-560 • MAGNATORCH BRAZING MACHINE

The new Magnatorch Brazing Machine from Weatherhead is perfect for making large numbers of FOR-SEAL® Tube Fitting Assemblies. By providing 360 degree induction heating, the brazing process is fast, clean and flameless. A heavy duty cart is also provided with table top work area, vise, and storage drawer to make up a complete brazing station. The T-560 includes one each of the following:

| Catalog Number | Qty. | Description |
|----------------|------|--|
| T-560-1 | 1 | Magnatorch Power Source |
| T-560-2 | 1 | Magnatorch Water System |
| T-560-3 | 1 | Magnatorch Induction Torch |
| T-560-4 | 1 | Magnatorch Power Cables |
| T-560-5 | 1 | Magnatorch Heating Coil #1 (1-1/4 I.D.) |
| T-560-6 | 1 | Magnatorch Heating Coil #2 (1-5/16 I.D.) |
| T-560-7 | 1 | Magnatorch Heating Coil #3 (2-1/4 I.D.) |
| T-560-8 | 1 | Magnatorch Torch Cart |

LABEL SETS

for FC-16X, C-63X and C-632X Cabinets



Full assortment available. Each label contains catalog number, illustration, size data and color coding for quick, positive identification of parts. Labels slide easily into slots on drawers and dividers.

| Catalog Number | Description |
|----------------|--|
| CL-16-1 | Standard Brass Fittings for FC-16X cabinet. |
| CL-16-2 | Air brake fittings for copper tubing. Use with FC-16X cabinet. |
| CL-16-3 | Air brake fittings for nylon tubing. Use with FC-16X cabinet. |
| CL-434 | Fuel Line Hose Fittings (series 057B). |
| CL-490 | Standard brass fittings, drain and shut-off cocks includes Compression, SAE, Inverted and Pipe, and series 057B fuel line hose fittings. |
| CL-491 | Air brake fittings for copper tubing. |
| CL-492 | Hydraulic brake fittings. |
| CL-493 | Barb-Tite® hose ends. |
| CL-494 | Master Set - contains one each of CL-490, CL-491, CL-492, CL-493. |
| CL-496 | Mini-Barb® fittings. |
| CL-497 | Air brake fittings for nylon tubing. |
| CL-498 | Polyline® fittings. |
| CL-499 | Push>Connect |
| CL-500 | Selfalign® |
| CL-501 | Plastic Fittings |
| CL-502 | Metric Adapters |
| CL-503 | QCAB® Fittings |

SELF-ADHESIVE LABEL SETS

for FH-15X and C-15X Cabinets



Labels are printed on self-adhesive stock for quick application. Each label contains an illustration of the part along with the catalog number and size information.

| Catalog Number | Description |
|----------------|--|
| FS-100 | Swivel Adapters |
| FS-200 | JIC 37° Flare Twin Steel Adapters |
| FS-300 | Split Flange Adapters, Split Flange Kits, O-Ring Port Adapters |
| FS-500 | Barb-Tite® Hose Ends |
| FS-501 | BL-456 Assortment Label Set |
| FS-800 | Air brake fitting for copper tubing and 338 "B" Series Hose Ends |
| FS-900 | Air brake fittings for nylon tubing |
| FS-1000 | Mini-Barb® fittings |
| FS-1600 | Flareless Ermeto® 7000 Series |
| FS-2000 | Steel pipe fittings |
| FS-2100 | Polyline® fittings |
| FS-2400 | FOR-SEAL® Adapters |
| FS-3300 | QCAB® Fittings |
| SH-53 | Weatherhead envelope 6" x 4-1/2" (Qty 500) |
| W-8022 | Standard brass fittings and drain-shut-off valves |

PLASTIC BAGS



Weatherhead heavy-duty plastic bags for Weatherhead fittings come in sizes 5"x6", 6"x10", and 8"x12". The bags include convenient spaces for labeling.

| Catalog Number | Description | Qty. |
|----------------|-------------|------|
| 5x6 PB | Plastic Bag | 100 |
| 6x10 PB | Plastic Bag | 100 |
| 8x12 PB | Plastic Bag | 100 |



FC-16X • STOCK CABINET

Contains 16 clear plastic drawers that can be divided into two or three sections. Illustrated color labels are available to provide instant identification of drawer contents.

Size: 16-1/8" wide x 11-3/4" high x 9" deep
Weight: 13 lbs.
Individual Drawers: PD-49
Dividers: PD-75 set (14/set)



C-15X • STOCK CABINET

Contains 15 extra large white drawers for those large, difficult to store fittings and valves. The 15 drawers may be divided into two or three sections to suit your particular needs.

Size: 30-1/4" Wide x 14-3/8" Deep x 13-5/8" High
Weight: 45 lbs.
Individual Drawers: CD-15
Dividers: CD-15D (30 per set)



FH-15X • STOCK CABINET

Here is the ideal way to organize your inventory of hose ends and adapters. Stock it anyway you want — to fit your particular needs. It can be used for field service, or as a jobber display and stock cabinet. The rugged FH-15X cabinet contains 15 plastic drawers for stocking hose ends and adapters.

Size: 30-1/4" Wide x 13-5/8" High x 14-3/8" Deep
Weight: 45 lbs.
Individual Drawers: PD-95
Dividers: PD-15 (30 per set)



C-63X • STOCK CABINET

A cabinet containing 63 drawers that can be divided into two or three sections. The bright color and attractive design make the C-63X stock cabinet a nice addition to any store front.

Used with assortments: AB-1400, CA-631, and CA-632.

Size: 30-1/4" wide x 25" high x 9-1/4" deep
Weight: 61 lbs.
Individual Drawers: PD-49
Dividers: PD-75 Set (14/set)



C-632X • Cabinet

This Weatherhead Brass Fittings Cabinet, C-632X, is a space saving, efficient, easy to use addition to the modern store with lobby type sales area. The C-632X requires a minimum of space but does a maximum job merchandising the wide variety of fittings in the 126 clear, wide, plastic drawers. An additional 15 large, high impact plastic drawers located in the bottom section provide ample space for those large or heavy special fittings you may be stocking.

Restocking is easy when you start at the bottom and pull drawers for an order check. Leave drawers extended that are low in stock. Now start at top, note quantity needed and return drawers to original position after order is written using standard box quantities listed on labels. Plastic dividers are provided to section drawers for future expansion when new or additional part numbers are needed.

Display this attractive cabinet with a recommended stock of fittings in your lobby and watch your brass fitting sales increase as the C-632X silently and quickly services your customers. Create those impulse sales that make your business and profits grow!

For complete **CA-632** assortment, see page 233.

CONTENTS

| Catalog Number | Description |
|------------------|---------------------------------|
| C-15X | 15 Drawer Cabinet |
| C-63X | 63 Drawer Cabinet |
| CB-63X | Cabinet Base |
| CD-15 | Plastic Drawer for C-15X |
| C-632X | 2—C-63X, 1—C-15X, 1—CB-63X |
| PD-49 | Drawers for C-63X |
| PD-75 set | Dividers for drawers (14 count) |

Size: 68-1/2" high, 30" wide, 15" deep.

Weight: 167 lbs.

CA-632 • FITTINGS ASSORTMENT

The CA-632 assortment combines a colorful, attractive lobby display unit and an assortment of fast moving brass fittings with coverage for most any application. This space saving assortment includes color coded, illustrated, labels for quick identification by customers of standard fittings, as well as fuel line, carburetion, metric and domestic hydraulic brake and thermoplastic brass fittings in 240 configurations and sizes. Be a supplier to auto dealers, brake specialists, RV shops, plant maintenance shops, truck and bus fleets, contractors, marinas, loggers, shipyards, fishing fleets, farmers and self installers for their brass fitting requirements. Contents of this assortment may vary as new fittings are introduced and stock fittings change in popularity.

Contents Only: [CA-632CO](#)

CA-632 Contents

| Catalog Number | Quantity | Catalog Number | Quantity | Catalog Number | Quantity | Catalog Number | Quantity |
|----------------|----------|----------------|----------|----------------|----------|----------------|----------|
| 05703B-102 | 5 | 302x5 | 10 | 3600x2 | 5 | 62x10 | 1 |
| 05704B-102 | 10 | 302x6 | 5 | 3600x4 | 5 | 6200x2 | 10 |
| 05704B-104 | 5 | 3129x2 | 5 | 3700x2 | 10 | 6200x3 | 10 |
| 05704B-C02 | 5 | 3150x2 | 10 | 3700x4 | 5 | 6200x4 | 10 |
| 05705B-102 | 10 | 3150x4 | 10 | 3700x6 | 5 | 6202 | 10 |
| 05705B-104 | 5 | 3151x2 | 10 | 3750x2 | 5 | 64x4 | 5 |
| 05705B-C02 | 10 | 3151x4 | 10 | 3750x4 | 5 | 64x6 | 5 |
| 05705B-C04 | 10 | 3151x6 | 10 | 402x3 | 10 | 66x2 | 10 |
| 05705B-1560 | 10 | 3151x8 | 5 | 402x4 | 10 | 66x3 | 10 |
| 05705B-1561 | 10 | 3152x2 | 10 | 402x4x4 | 5 | 66x4 | 10 |
| 05706B-102 | 10 | 3152x4 | 10 | 402x5 | 10 | 66x6 | 5 |
| 05706B-104 | 10 | 3152x6 | 10 | 402x5x4 | 10 | 6660 | 5 |
| 05706B-106 | 5 | 3152x8 | 5 | 402x6 | 10 | 6749 | 1 |
| 05706B-C02 | 5 | 3152x12 | 2 | 41x3 | 10 | 68x2 | 10 |
| 05706B-C04 | 5 | 3200x2 | 10 | 41x4 | 10 | 68x3 | 10 |
| 05706B-1568 | 5 | 3200x4 | 5 | 41x5 | 10 | 68x4 | 10 |
| 05706B-1570 | 5 | 3200x4x2 | 10 | 41x6 | 10 | 68x4x4 | 10 |
| 100x3 | 10 | 3200x6x4 | 5 | 41x8 | 5 | 68x5 | 10 |
| 100x4 | 10 | 3200x8x6 | 5 | 42x4 | 5 | 68x5x4 | 10 |
| 100x5 | 10 | 3220x4x2 | 20 | 42x6 | 5 | 68x6 | 10 |
| 100x6 | 10 | 3220x6x2 | 10 | 48x3 | 10 | 68x6x2 | 10 |
| 105x2 | 10 | 3220x6x4 | 10 | 48x4 | 10 | 68x6x6 | 5 |
| 105x3 | 20 | 3220x8x2 | 5 | 48x4x4 | 10 | 68x8 | 5 |
| 105x4 | 20 | 3220x8x4 | 10 | 48x5 | 10 | 6809 | 5 |
| 105x5 | 20 | 3220x8x6 | 5 | 48x5x4 | 10 | 6829 | 5 |
| 105x6 | 10 | 3220x12x6 | 2 | 48x6 | 10 | 6892 | 5 |
| 131x3 | 10 | 3220x12x8 | 2 | 48x6x2 | 5 | 69x2 | 10 |
| 131x4 | 10 | 3300x2 | 10 | 48x6x6 | 5 | 69x3 | 10 |
| 131x5 | 10 | 3300x4 | 10 | 48x8 | 5 | 69x4 | 10 |
| 131x6 | 10 | 3300x4x2 | 10 | 49x4 | 10 | 69x4x4 | 10 |
| 135 | 10 | 3300x6 | 5 | 49x4x4 | 5 | 69x5 | 10 |
| 140 | 5 | 3300x6x4 | 5 | 49x5 | 10 | 69x5x4 | 10 |
| 1442 | 5 | 3300x8 | 5 | 49x5x4 | 5 | 69x6 | 10 |
| 1443 | 5 | 3300x8x6 | 5 | 49x6 | 10 | 69x6x2 | 5 |
| 145 | 10 | 3325x2 | 10 | 49x8 | 5 | 69x6x6 | 5 |
| 1514 | 5 | 3325x4 | 10 | 60x2 | 50 | 69x8 | 5 |
| 1538 | 10 | 3325x4x2 | 5 | 60x3 | 50 | 7818 | 5 |
| 1548 | 10 | 3325x6 | 5 | 60x4 | 50 | 7828 | 5 |
| 1539 | 10 | 3325x6x4 | 5 | 60x5 | 50 | 7829 | 5 |
| 1540 | 10 | 3326x2 | 10 | 60x6 | 50 | 7896x3 | 5 |
| 202x3 | 10 | 3326x4 | 10 | 60x8 | 20 | 7896x4 | 5 |
| 202x4 | 10 | 3326x6 | 10 | 60x10 | 10 | 7904 | 5 |
| 202x4x4 | 10 | 3326x8 | 5 | 61x2 | 10 | 7906 | 5 |
| 202x5 | 10 | 3327x2 | 10 | 61x3 | 20 | 7908 | 2 |
| 202x5x4 | 10 | 3327x4 | 5 | 61x4 | 20 | 7914 | 2 |
| 202x6 | 10 | 3328x2 | 10 | 61x5 | 20 | 7934A | 5 |
| 202x6x2 | 5 | 3328x4 | 5 | 61x6 | 10 | 7935 | 5 |
| 2030x4 | 10 | 3328x6 | 5 | 61x8 | 10 | 7936 | 5 |
| 2030x44 | 10 | 3350x2 | 5 | 6100x2 | 10 | 7937 | 5 |
| 2030x5 | 10 | 3350x4 | 5 | 6100x3 | 10 | 7940 | 5 |
| 2030x6 | 10 | 3350x6 | 5 | 6100x4 | 10 | 7941 | 5 |
| 2030x8 | 5 | 3400x2 | 10 | 62x2 | 10 | C-632X | 1 |
| 252x3 | 10 | 3400x4 | 10 | 62x3 | 10 | CL-490 | 1 |
| 252x4 | 10 | 3400x6 | 5 | 62x4 | 10 | | |
| 270 | 5 | 3400x8 | 5 | 62x5 | 10 | | |
| 302x3 | 10 | 3500x2 | 10 | 62x6 | 10 | | |
| 302x4 | 10 | 3500x4 | 10 | 62x8 | 5 | | |



CA-631 • BRASS FITTINGS ASSORTMENT

This merchandiser will help you organize your brass fittings in an attractive 63 drawer cabinet. It includes a stock of the 100 fastest moving brass fittings to better service your customers. To expand, divide the clear, easy to inventory, super sized plastic drawers in half or thirds with plastic dividers provided. Illustrated, color-coded labels in a wide range of fitting types provide instant identification of drawer contents. Your lobby and sales will be improved with this modern display set up on a gondola or shelf. Contents may vary as new numbers become available and popularity changes.

Contents Only: [CA-631CO](#)
Cabinet Only: [C-63X](#)

CA-631 Contents

| Catalog Number | Qty. | Catalog Number | Qty. | Catalog Number | Qty. | Catalog Number | Qty. | Catalog Number | Qty. | Catalog Number | Qty. |
|----------------|------|----------------|------|----------------|------|----------------|------|----------------|------|----------------|------|
| 105x3 | 20 | 302x4 | 10 | 3200x4x2 | 10 | 3326x6 | 10 | 48x4x4 | 10 | 62x2 | 10 |
| 105x4 | 20 | 302x5 | 10 | 3200x6x4 | 5 | 3327x2 | 5 | 48x5 | 10 | 62x3 | 10 |
| 105x5 | 20 | 302x6 | 5 | 3220x4x2 | 20 | 3327x4 | 5 | 48x5x4 | 10 | 62x4 | 10 |
| 105x6 | 10 | 402x4 | 10 | 3220x6x2 | 10 | 3328x2 | 5 | 48x6 | 10 | 62x5 | 10 |
| 131x3 | 10 | 402x5 | 10 | 3220x6x4 | 10 | 3328x4 | 5 | 48x6x6 | 5 | 62x6 | 10 |
| 131x4 | 10 | 402x6 | 10 | 3220x8x2 | 5 | 3350x2 | 5 | 49x4 | 5 | 68x2 | 10 |
| 131x5 | 10 | 3150x2 | 5 | 3220x8x4 | 10 | 3350x4 | 5 | 49x6 | 10 | 68x3 | 10 |
| 131x6 | 10 | 3150x4 | 5 | 3220x8x6 | 5 | 3400x2 | 10 | 60x2 | 50 | 68x4 | 10 |
| 135 | 10 | 3151x2 | 10 | 3300x2 | 10 | 3400x4 | 10 | 60x3 | 50 | 68x4x4 | 10 |
| 145 | 10 | 3151x4 | 10 | 3300x4 | 10 | 3400x6 | 5 | 60x4 | 50 | 68x5 | 10 |
| 202x3 | 10 | 3151x6 | 10 | 3300x4x2 | 10 | 3700x2 | 10 | 60x5 | 50 | 68x5x4 | 10 |
| 202x4 | 10 | 3151x8 | 10 | 3300x6 | 5 | 3700x4 | 5 | 60x6 | 50 | 68x6 | 10 |
| 202x4x4 | 10 | 3152x2 | 10 | 3300x6x4 | 5 | 3750x4 | 5 | 61x2 | 10 | 68x6x2 | 10 |
| 202x5 | 10 | 3152x4 | 10 | 3325x2 | 10 | 3750x6 | 2 | 61x3 | 10 | 69x4 | 10 |
| 202x5x4 | 10 | 3152x6 | 10 | 3325x4 | 10 | 41x4 | 10 | 61x4 | 10 | 69x6 | 10 |
| 202x6 | 5 | 3152x8 | 5 | 3326x2 | 10 | 41x6 | 10 | 61x5 | 10 | C-63X | 1 |
| 302x3 | 10 | 3200x2 | 5 | 3326x4 | 10 | 48x4 | 10 | 61x6 | 10 | CL-490 | 1 |



FC-161 • BRASS FITTINGS ASSORTMENT

The FC-161 brass fitting assortment contains the fastest moving SAE 45° Flare, Inverted Flare, Compression and Pipe catalog numbers to give your customers maximum coverage at a low cost. Nuts, sleeves and unions make an ideal stock for any small repair, auto, boat, lawn mower, or fixit shop. Cabinet includes 16 clear plastic drawers and color-coded labels for easy identification. The FC-161 fits on any shelf and goes to work immediately.

Cabinet Only: [FC-16X](#)

FC-161 Contents

| Catalog Number | Qty. | Catalog Number | Qty. | Catalog Number | Qty. | Catalog Number | Qty. | Catalog Number | Qty. | Catalog Number | Qty. |
|----------------|------|----------------|------|----------------|------|----------------|------|----------------|------|----------------|------|
| 105x3 | 10 | 302x5 | 2 | 402x3 | 2 | 48x6 | 2 | 61x3 | 10 | 68x4 | 2 |
| 105x4 | 10 | 3151x2 | 2 | 402x4 | 2 | 49x4 | 2 | 61x4 | 10 | 68x5 | 2 |
| 105x5 | 10 | 3151x4 | 2 | 402x5 | 2 | 49x5 | 2 | 61x5 | 10 | 68x6 | 2 |
| 105x6 | 5 | 3220x4x2 | 5 | 41x4 | 2 | 49x6 | 2 | 61x6 | 5 | 69x4 | 2 |
| 145 | 5 | 3220x6x4 | 5 | 41x5 | 2 | 60x3 | 20 | 62x3 | 5 | 69x5 | 2 |
| 202x4 | 2 | 3300x2 | 5 | 41x6 | 2 | 60x4 | 20 | 62x4 | 5 | 69x6 | 2 |
| 202x5 | 2 | 3300x4 | 2 | 48x4 | 2 | 60x5 | 20 | 62x5 | 5 | CL-16-1 | 1 |
| 302x3 | 5 | 3400x2 | 5 | 48x5 | 2 | 60x6 | 20 | 62x6 | 5 | FC-16X | 1 |
| 302x4 | 5 | 3400x4 | 5 | | | | | | | | |



SS-85 • STANDARD BRASS FITTINGS ASSORTMENT

Instant service for service stations, car dealers, repair shops. Contains 85 of the fastest moving Weatherhead brass fittings.

Compact, lightweight plastic box stores easily in a drawer, shelf or service truck. Saves you time and money by having the right fitting when it is needed. Eliminates searching and make-shift repairs by giving you the right part when you need it most.

SIZE: 11" wide, 1-3/4" high, 6-3/4" deep. **WEIGHT:** 3-1/4 lbs.

| Catalog Number | Qty. | Catalog Number | Qty. | Catalog Number | Qty. |
|----------------|------|----------------|------|----------------|------|
| 105x3 | 5 | 3300x2 | 5 | 62x3 | 2 |
| 105x4 | 5 | 402x4 | 2 | 62x4 | 5 |
| 105x5 | 10 | 60x3 | 5 | 62x5 | 5 |
| 202x4 | 5 | 60x4 | 10 | 62x6 | 2 |
| 202x5 | 5 | 60x5 | 5 | 68x4 | 2 |
| 3151x2 | 2 | 60x6 | 5 | BF-40X | 1 |
| 3220x4x2 | 5 | | | | |



SS-86 • COMPRESSION FITTINGS ASSORTMENT

Assortment contains 80 of the fastest moving compression fittings.

SIZE: 11" wide, 1-3/4" high, 6-3/4" deep. **WEIGHT:** 3-1/2 lbs.

| Catalog Number | Qty. | Catalog Number | Qty. | Catalog Number | Qty. |
|----------------|------|----------------|------|----------------|------|
| 60x3 | 5 | 61x5 | 5 | 68x3 | 2 |
| 60x4 | 10 | 61x6 | 5 | 68x4 | 5 |
| 60x5 | 5 | 62x3 | 5 | 68x5 | 2 |
| 60x6 | 5 | 62x4 | 5 | 69x3 | 2 |
| 61x3 | 5 | 62x5 | 5 | 69x4 | 5 |
| 61x4 | 5 | 62x6 | 2 | 69x5 | 2 |
| | | | | BF-40X | 1 |



SS-87 • INVERTED FLARE ASSORTMENT

Assortment contains 84 of the fastest moving inverted fittings.

SIZE: 11" wide, 1-3/4" high, 6-3/4" deep. **WEIGHT:** 3-1/2 lbs.

| Catalog Number | Qty. | Catalog Number | Qty. | Catalog Number | Qty. |
|----------------|------|----------------|------|----------------|------|
| 105x3 | 5 | 202x5 | 5 | 402x3 | 5 |
| 105x4 | 5 | 202x6 | 2 | 402x4 | 5 |
| 105x5 | 5 | 302x3 | 5 | 402x5 | 5 |
| 105x6 | 5 | 302x4 | 5 | 402x6 | 5 |
| 202x3 | 5 | 302x5 | 5 | 7896x3 | 5 |
| 202x4 | 5 | 302x6 | 2 | 7896x4 | 5 |
| | | | | BF-40X | 1 |



SS-88 • BRASS PIPE ASSORTMENT

Assortment contains 59 of the fastest moving brass pipe fittings.

SIZE: 11" wide, 1-3/4" high, 6-3/4" deep. **WEIGHT:** 3-1/2 lbs.

| Catalog Number | Qty. | Catalog Number | Qty. | Catalog Number | Qty. |
|----------------|------|----------------|------|----------------|------|
| 3152x2 | 5 | 3326x2 | 5 | 3400x2 | 5 |
| 3152x4 | 5 | 3326x4 | 5 | 3400x4 | 2 |
| 3152x6 | 2 | 3326x6 | 2 | 3400x6 | 2 |
| 3220x4x2 | 2 | 3350x2 | 5 | 3500x2 | 2 |
| 3220x6x4 | 2 | 3350x4 | 4 | 3500x4 | 2 |
| 3300x2 | 5 | 3350x6 | 2 | BF-40X | 1 |
| 3300x4 | 2 | | | | |



BF-40 • HYDRAULIC BRAKE FITTINGS ASSORTMENT

The BF-40 assortment of fast moving hydraulic brake fittings is a must for any shop doing brake service work. Contains the adapters needed to convert large size ports in master cylinders to accept standard steel brake lines plus the brass tees used in the installation of electric towed trailer brakes.

Assortment is organized in a compact, handy plastic box for easy selection.

SIZE: 11" wide, 1-3/4" high, 6-3/4" deep. **WEIGHT:** 4 lbs. (approx.)

| Catalog Number | Qty. | Catalog Number | Qty. | Catalog Number | Qty. |
|----------------|------|----------------|------|----------------|------|
| 7818 | 2 | 7901 | 2 | 7911 | 2 |
| 7828 | 2 | 7904 | 2 | 7912 | 2 |
| 7829 | 2 | 7905 | 2 | 7913 | 2 |
| 7897 | 2 | 7906 | 2 | 7914 | 2 |
| 7898 | 2 | 7908 | 2 | 7917 | 2 |
| 7900 | 2 | 7910 | 2 | 7933 | 2 |
| | | | | BF-40X | 1 |



BF-41 • HYDRAULIC BRAKE LINE ADAPTER ASSORTMENT

The BF-41 assortment contains the adapters needed to convert the oversize master cylinder ports to accept the inverted flare nut used on standard replacement steel brake lines. The adapters eliminate the need to cut line, install oversize nut and double flare tubing as well as converting the port to standard size threads for the life of the car. Extra standard nuts and the unions needed to connect two steel brake lines when a non-standard length is required are also included in the assortment. The contents including the illustrations of parts are shown on the inside cover of the box.

SIZE: 11" wide, 1-3/4" high, 6-3/4" deep. **WEIGHT:** 4 lbs. (approx.)

| Catalog Number | Qty. | Catalog Number | Qty. | Catalog Number | Qty. |
|----------------|------|----------------|------|----------------|------|
| 105x3 | 10 | 302x4 | 5 | 7896x3 | 5 |
| 105x4 | 10 | 302x5 | 5 | 7896x4 | 5 |
| 105x5 | 10 | 302x6 | 2 | 7897 | 2 |
| 105x6 | 5 | 7818 | 2 | 7908 | 2 |
| 105x6x7 | 2 | 7828 | 2 | 7917 | 2 |
| 302x3 | 5 | 7829 | 2 | BF-40X | 1 |



BF-42 • RV BRAKE LINE ADAPTER ASSORTMENT

The BF-42 assortment contains the adapter tees required to install the control switch used to coordinate the electric trailer brakes with the hydraulic brakes on towing vehicle. The assortment also contains inverted brake line nuts and unions needed to make up non-standard steel brake line lengths.

SIZE: 11" wide, 1-3/4" high, 6-3/4" deep. **WEIGHT:** 4 lbs.

| Catalog Number | Qty. | Catalog Number | Qty. | Catalog Number | Qty. |
|----------------|------|----------------|------|----------------|------|
| 105x3 | 10 | 302x5 | 5 | 7906 | 1 |
| 105x4 | 10 | 7898 | 1 | 7914 | 1 |
| 105x5 | 10 | 7900 | 1 | 7921 | 1 |
| 105x6 | 5 | 7901 | 1 | 7933 | 1 |
| 105x6x7 | 2 | 7904 | 1 | BF-40X | 1 |
| 302x3 | 5 | 7905 | 1 | | |
| 302x4 | 5 | | | | |



BF-43 • METRIC BRAKE ADAPTER AND TEE ASSORTMENT

The BF-43 assortment contains metric thread connectors to adapt the three port sizes in late model GM cars to use a steel brake line with metric threads (M10x1.0) and standard flare (Weatherhead J series). Included as well are metric adapters to convert European Bubble flare type ports to accept standard 3/16" U.S. steel brake lines, and metric towed trailer brake tees used in controls of electric trailer brakes. The 3/16" unions are used for joining metric and U.S. steel brake lines to make up non-standard lengths.

SIZE: 11" wide, 1-3/4" high, 6-3/4" deep.

| Catalog Number | Qty. | Catalog Number | Qty. | Catalog Number | Qty. |
|----------------|------|----------------|------|----------------|------|
| 105x3 | 10 | 7935 | 1 | 7974 | 1 |
| 105x4 | 5 | 7936 | 1 | 7975 | 1 |
| 1442 | 5 | 7937 | 1 | 7896x3 | 5 |
| 1443 | 5 | 7940 | 5 | 7896x4 | 5 |
| 302x3 | 5 | 7941 | 5 | BF-40X | 1 |
| 7921 | 1 | 7970 | 2 | | |
| 7934A | 5 | 7972 | 1 | | |



DC-121 • PLASTIC DRAIN COCK ASSORTMENT

To address your plastic drain cock needs, Weatherhead now offers a full assortment of domestic and offshore drain cocks. This kit comes complete with a plastic box and a label with part number and application information.

| Catalog Number | Qty. | Catalog Number | Qty. | Catalog Number | Qty. |
|----------------|------|----------------|------|----------------|------|
| 110 | 2 | 113 | 2 | 116 | 2 |
| 111 | 2 | 114 | 2 | 117 | 2 |
| 112 | 2 | 115 | 2 | 135 | 2 |
| | | | | 145 | 2 |

PC-48 • PUSH > CONNECT FITTINGS ASSORTMENT

Weatherhead PUSH > CONNECT fittings are designed for quick assembly without the need for a wrench. Ideal for pneumatic applications where space is tight. Then fittings are also easily disconnected; simply depress the collet ring with two fingers and withdraw the tube. The PC-48 provides the 48 most popular PUSH > CONNECT fittings in a compact, handy plastic box to make your assortment organized and accessible.



| Catalog Number | Qty. | Catalog Number | Qty. | Catalog Number | Qty. |
|----------------|------|----------------|------|----------------|------|
| 1162x2 | 5 | 1168x2.5A | 5 | 1169x4S | 5 |
| 1162x4 | 5 | 1168x2.5x4 | 5 | 1169x4x4S | 5 |
| 1162x6 | 5 | 1168x2x4 | 5 | 1169x4x6S | 5 |
| 1164x2.5 | 5 | 1168x4 | 5 | 1169x6S | 5 |
| 1164x4 | 5 | 1168x4A | 5 | 1169x6x6S | 5 |
| 1164x6 | 5 | 1168x4x4 | 5 | 1169x8S | 2 |
| 1164x8 | 2 | 1168x4x6 | 5 | 1169x8x4S | 2 |
| 1165x2.5 | 5 | 1168x5 | 5 | 1171x4S | 5 |
| 1165x4 | 5 | 1168x5x4 | 5 | 1171x4x4S | 5 |
| 1165x6 | 5 | 1168x6 | 5 | 1171x6S | 5 |
| 1165x8 | 2 | 1168x6x6 | 5 | 1172x4S | 5 |
| 1166x4 | 5 | 1168x6x8 | 2 | 1172x4x4S | 5 |
| 1166x4x4 | 5 | 1168x8 | 5 | 1174x2 | 5 |
| 1166x6 | 5 | 1168x8x8 | 2 | 1174x4 | 5 |
| 1166x6x6 | 2 | 1169x2.5S | 5 | CL-499 | 1 |
| 1168x2 | 2 | 1169x2S | 5 | FC-16X | 1 |
| 1168x2.5 | 5 | 1169x2x4S | 5 | | |



BA-84 • STEEL BRAKE LINE ASSORTMENT

The BA-84 attractive lobby merchandiser displays domestic as well as import car (British, European and Japanese) steel brake lines. The BA-84 puts brake lines where users can make fast and easy selection from a complete inventory protected by sturdy cardboard color-coded tubes.

The corrosion and vibration resistant double wall steel brake lines are easily formed into the configurations you need without kinking. Longer or non-standard lengths can be made up by joining two lines with a Weatherhead union of the proper thread size.

The BA-84 includes all sizes of the 3/16", 1/4" and 5/16" Weatherhead steel brake lines for domestic cars and trucks plus a sturdy steel rack. Order the SB series (Jaguar, M.G., Triumph), SC series (BMW, Mercedes, Peugeot, Porsche, Volkswagen), SJ series (Mazda, Nissan, Toyota) and Weatherhead import car steel brake lines and unions from listings in brake line section of this catalog. See page 128.

Increase your sales — Organize your inventory — Make selections easy — Discover the results of putting this proven money maker to work for you — Install a BA-84 **NOW**.

| 3/16" LINES | | | 1/4" LINES | | |
|-------------|----------------|----------|------------|----------------|----------|
| Length | Catalog Number | Quantity | Length | Catalog Number | Quantity |
| 6" | S306 | 4 | 12" | S412 | 4 |
| 8" | S308 | 4 | 20" | S420 | 4 |
| 12" | S312 | 4 | 30" | S430 | 4 |
| 20" | S320 | 4 | 40" | S440 | 4 |
| 30" | S330 | 4 | 51" | S451 | 4 |
| 40" | S340 | 4 | 60" | S460 | 4 |
| 51" | S351 | 4 | | | |
| 60" | S360 | 4 | | | |
| 72" | S372 | 4 | | | |

| 5/16" LINES | | | | | |
|-------------|----------------|----------|--------|----------------|----------|
| Length | Catalog Number | Quantity | Length | Catalog Number | Quantity |
| 12" | S512 | 4 | Rack | BA-84X | 1 |
| 20" | S520 | 4 | | | |
| 30" | S530 | 4 | | | |
| 40" | S540 | 4 | | | |
| 51" | S551 | 4 | | | |
| 60" | S560 | 4 | | | |

RELATED
PROD

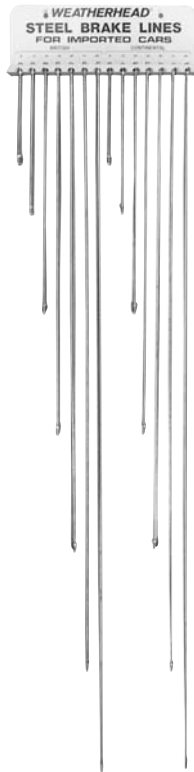

BA-24 • STEEL BRAKE LINE ASSORTMENT

The BA-24 assortment includes an assortment of 5/16" steel brake lines and a rack for wall or bin installation. The multi-walled corrosion resistant tubing can be easily formed for time saving installation. All lines have color-coded label attached for easy identification. Non-standard lengths can be made up by joining two standard lengths with a 302x5 union. **WEIGHT:** 6 lbs.

| Length | Catalog Number | Quantity | Length | Catalog Number | Quantity | Length | Catalog Number | Quantity |
|--------|----------------|----------|--------|----------------|----------|--------|----------------|----------|
| 12" | S512 | 4 | 30" | S530 | 4 | 51" | S551 | 4 |
| 20" | S520 | 4 | 40" | S540 | 4 | 60" | S560 | 4 |
| | | | | | | Rack | BA-24X | 1 |

BA-28 • STEEL BRAKE LINE ASSORTMENT

BA-28 contains 3/16" easy to form, anti-corrosive, multi-walled steel brake lines for Japanese vehicles. The SJ lines with 10-1.0mm threads (standard flare) can be joined to form longer lines by using the 7934A Japanese metric union. The handy wall rack is included.

| Length | Catalog Number | Quantity | Length | Catalog Number | Quantity | Length | Catalog Number | Quantity |
|--------|----------------|----------|--------|----------------|----------|--------|----------------|----------|
| 8" | SJ308 | 4 | 30" | SJ330 | 4 | 51" | SJ351 | 4 |
| 12" | SJ312 | 4 | 40" | SJ340 | 4 | 60" | SJ360 | 4 |
| 20" | SJ320 | 4 | | | | Rack | BA-28X | 1 |

BA-38 • STEEL BRAKE LINE ASSORTMENT

BA-38 contains six different lengths made of 3/8" multi-walled, easily formed, anti-corrosive steel tubing with inverted flare nuts attached. All lines have color-coded label for easy identification. Non-standard length lines may be fabricated by joining two 3/8" steel lines with a 302x6 union. **WEIGHT:** 8 lbs.

| Length | Catalog Number | Quantity | Length | Catalog Number | Quantity | Length | Catalog Number | Quantity |
|--------|----------------|----------|--------|----------------|----------|--------|----------------|----------|
| 12" | S612 | 4 | 30" | S630 | 4 | 51" | S651 | 4 |
| 20" | S620 | 4 | 40" | S640 | 4 | 60" | S660 | 4 |
| | | | | | | Rack | BA-38X | 1 |

BA-48 • STEEL BRAKE LINE ASSORTMENT

BA-48 contains the most popular steel brake lines and an easy to install rack. The 3/16" and 1/4" steel brake lines are available in six different lengths. Each steel brake line has a standard inverted flare nut on one end and a long thread inverted flare nut on the other end for better sealing. Easy to form, multi-walled steel tubing resists corrosion and vibration.

Non-standard length lines may be fabricated by joining two 3/16" lines with a 302x3 and two 1/4" lines with a 302x4. **WEIGHT:** 10-1/2 lbs.

| 3/16" LINES | | | 1/4" LINES | | | 1/4" LINES | | |
|-------------|----------------|----------|------------|----------------|----------|------------|----------------|----------|
| Length | Catalog Number | Quantity | Length | Catalog Number | Quantity | Length | Catalog Number | Quantity |
| 12" | S312 | 4 | 12" | S412 | 4 | 51" | S451 | 4 |
| 20" | S320 | 4 | 20" | S420 | 4 | 60" | S460 | 4 |
| 30" | S330 | 4 | 30" | S430 | 4 | Rack | BA-48X | 1 |
| 40" | S340 | 4 | 40" | S440 | 4 | | | |
| 51" | S351 | 4 | | | | | | |
| 60" | S360 | 4 | | | | | | |

BA-56 • STEEL BRAKE LINE ASSORTMENT

BA-56 contains 3/16" easy to form, anti-corrosive, multi-walled steel brake lines for British and European cars. The SB lines with 3/8-24 threads (Bubble Flare) can be joined to form longer lines by using the 7940 metric union. SC lines with 10X1.0mm threads (Bubble Flare) can be joined with the 7941 metric union. The handy wall rack is included. **WEIGHT:** 10 lbs.

| British 3/8-24 Thread | | | European 10-1.0mm Thread | | | European 10-1.0mm Thread | | |
|-----------------------|----------------|----------|--------------------------|----------------|----------|--------------------------|----------------|----------|
| Length | Catalog Number | Quantity | Length | Catalog Number | Quantity | Length | Catalog Number | Quantity |
| 8" | SB308 | 4 | 8" | SC308 | 4 | 40" | SC340 | 4 |
| 12" | SB312 | 4 | 12" | SC312 | 4 | 51" | SC351 | 4 |
| 20" | SB320 | 4 | 20" | SC320 | 4 | 60" | SC360 | 4 |
| 30" | SB330 | 4 | 30" | SC330 | 4 | Rack | BA-56X | 1 |
| 40" | SB340 | 4 | | | | | | |
| 51" | SB351 | 4 | | | | | | |
| 60" | SB360 | 4 | | | | | | |

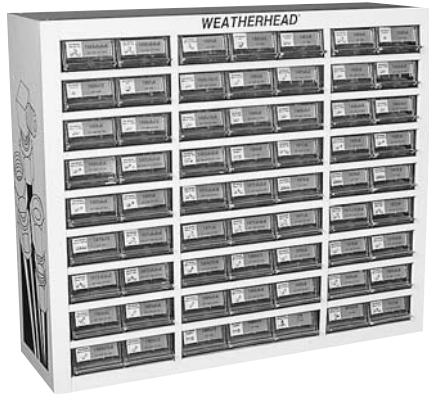

AB-1400 • AIR BRAKE FITTINGS ASSORTMENT

The AB-1400 contains DOT approved brass air brake fittings for servicing nylon brake and secondary air lines. Selecting the proper fittings from the 63 drawer cabinet included with assortment is easy. Clear, wide plastic drawers with color-coded labels make identification of shapes and sizes quick and simple. Order Weatherhead NT100 nylon air brake tubing to complete your nylon air brake line service center.

AB-1400 Contents

| Catalog Number | Quantity | Catalog Number | Quantity | Catalog Number | Quantity | Catalog Number | Quantity |
|----------------|----------|----------------|----------|----------------|----------|----------------|----------|
| 1460x4 | 10 | 1464x6 | 5 | 1469x6 | 10 | 1472x6 | 5 |
| 1460x6 | 20 | 1464x8 | 5 | 1469x6L | 5 | 1472x8 | 5 |
| 1460x8 | 10 | 1466x6 | 5 | 1469x6x2 | 5 | 1480x6 | 5 |
| 1460x10 | 10 | 1466x6x6 | 5 | 1469x6x6 | 5 | 1480x6x6 | 5 |
| 1460x12 | 10 | 1466x8 | 5 | 1469x8 | 5 | 1480x8 | 5 |
| 1461x4 | 5 | 1468x4 | 5 | 1469x8x4 | 5 | 1480x10 | 4 |
| 1461x6 | 10 | 1468x4x4 | 5 | 1469x10 | 5 | 1484x4 | 20 |
| 1461x8 | 5 | 1468x6 | 10 | 1469x10x6 | 4 | 1484x6 | 20 |
| 1461x10 | 5 | 1468x6x2 | 5 | 1469x12 | 4 | 1484x8 | 20 |
| 1461x12 | 5 | 1468x8 | 5 | 1471x4 | 5 | 1484x10 | 10 |
| 1462x4 | 5 | 1468x10 | 5 | 1471x6 | 5 | 1484x12 | 10 |
| 1462x6 | 10 | 1468x12 | 4 | | | C-63X | 1 |
| 1462x8 | 5 | 1469x4 | 5 | | | CL-497 | 1 |
| 1462x10 | 4 | 1469x4x4 | 5 | | | | |
| 1462x12 | 2 | | | | | | |



AB-140 • 1400 SERIES AIR BRAKE FITTINGS ASSORTMENT

This assortment of 1/4", 3/8", 1/2" air brake fittings designed for use with NT100 nylon air brake tubing provides the coverage needed for service work by fleets, repair shops and farm implement dealers. The DOT approved air brake fittings are easily selected from the cabinet with 16 plastic drawers and color-coded labels included in the assortment.

AB-140 Contents

| Catalog Number | Quantity | Catalog Number | Quantity | Catalog Number | Quantity | Catalog Number | Quantity |
|----------------|----------|----------------|----------|----------------|----------|----------------|----------|
| 1460x4 | 20 | 1461x8 | 5 | 1468x6 | 10 | 1484x6 | 20 |
| 1460x6 | 20 | 1462x4 | 5 | 1468x8 | 5 | 1484x8 | 20 |
| 1460x8 | 20 | 1462x6 | 10 | 1469x4 | 5 | 145 | 10 |
| 1461x4 | 10 | 1462x8 | 4 | 1469x6 | 5 | CL-16-3 | 1 |
| 1461x6 | 10 | 1468x4 | 10 | 1469x8 | 5 | FC-16X | 1 |
| | | | | 1484x4 | 20 | W15310 | 5 |

QC-18

Designed as a glove box sized emergency repair kit, the QC-18 assortment contains Q-CAB® tube unions in 5/32", 3/16", 1/4", 3/8" and 1/2" sizes, also included is a T-191 tubing cutter. The contents are contained in a convenient carrying case measuring 1-1/4"x3-3/4"x7".



| Component Part Number | Quantity |
|-----------------------|----------|
| 1862x2.5 | 2 |
| 1862x3 | 2 |
| 1862x4 | 2 |
| 1862x6 | 2 |
| 1862x8 | 2 |
| T-191 | 1 |
| QC-18X | 1 |

QC-180

The QC180 contains tube unions, male connectors, swivel male 45° elbow, male 90° elbows and repair kits in popular 1/4", 3/8" and 1/2" tube sizes designed for D.O.T. Truck and Trailer Air Brake System needs (see complete listing below). The Q-CAB® fittings are field proven with over millions of miles of leak free performance. Their design can save up to 75% of the assembly time over conventional compression fittings. These fittings are contained in a case measuring 1-3/4"x6-3/4"x1-3/4".



| QC-180 | Contents Part Number | Quantity | Contents Part Number | Quantity |
|----------|----------------------|----------|----------------------|----------|
| | 1862x3 | 2 | 1869x6x6 | 2 |
| 1862x4 | 2 | 1869x8x8 | 1 | |
| 1862x6 | 2 | 1880x4x4 | 2 | |
| 1862x8 | 2 | 1880x6x6 | 2 | |
| 1868x2.5 | 2 | 1880x8x8 | 1 | |
| 1868x3 | 2 | 1800Kx4 | 2 | |
| 1868x4x4 | 2 | 1800Kx6 | 2 | |
| 1868x6x6 | 2 | 1800Kx8 | 2 | |
| 1868x8x8 | 2 | 1800TRK | 1 | |
| 1869x4x4 | 2 | BF-40X | 1 | |

QC-1800

This assortment contains a solid inventory of popular Weatherhead Q-CAB® fittings designed for D.O.T. Truck and Trailer Air Brake System needs (see complete listing below). The Q-CAB® fittings are field proven with over millions of of leak free performance. Their design can save up to 75% of the assembly time over conventional compression fittings.



| QC-1800 | Contents Part Number | Quantity | Contents Part Number | Quantity | Contents Part Number | Quantity | Contents Part Number | Quantity |
|----------|----------------------|------------|----------------------|-----------|----------------------|----------|----------------------|----------|
| | 1800Kx2.5 | 4 | 1862x10 | 2 | 1868x12 | 2 | 1874x6x6 | 1 |
| 1800Kx3 | 4 | 1868x2.5x1 | 5 | 1869x4 | 5 | 1874x8x8 | 1 | |
| 1800Kx4 | 4 | 1868x2.5 | 5 | 1869x4x4 | 5 | 1880x4x4 | 5 | |
| 1800Kx6 | 4 | 1868x3 | 5 | 1869x6 | 5 | 1880x6x6 | 5 | |
| 1800Kx8 | 4 | 1868x4 | 5 | 1869x8 | 5 | 1880x8x8 | 5 | |
| 1800Kx10 | 2 | 1868x4x4 | 5 | 1869x8x8 | 5 | 1880x10 | 2 | |
| 1800Kx12 | 2 | 1868x6 | 5 | 1869x10 | 2 | 1880x12 | 2 | |
| 1862x2.5 | 2 | 1868x6x6 | 5 | 1869x4S | 5 | 1800T | 1 | |
| 1862x3 | 5 | 1868x8 | 5 | 1869x4x4S | 5 | CL-503 | 1 | |
| 1862x4 | 5 | 1868x8x8 | 5 | 1869x6S | 5 | FC-16X | 1 | |
| 1862x6 | 5 | 1868x10x6 | 2 | 1869x8S | 5 | T-191 | 1 | |
| 1862x8 | 5 | 1868x10 | 2 | 1874x4x4 | 1 | | | |

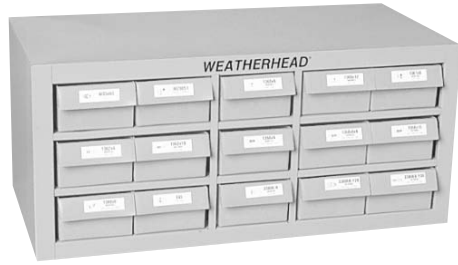

AB-45 • AIR BRAKE FITTINGS ASSORTMENT

This assortment of draincocks, shutoffs and air brake fittings for use with 1/4", 3/8", 1/2" copper tubing is a must for jobbers and fleet service shops. Provides excellent coverage for air brake tube and hose service requirements. The large plastic drawers and the illustrated labels for the 15 drawer cabinet included in assortment make positive part selection simple and quick.

AB-45 Contents

| Catalog Number | Quantity | Catalog Number | Quantity | Catalog Number | Quantity | Catalog Number | Quantity |
|----------------|----------|----------------|----------|----------------|----------|----------------|----------|
| 1360x6 | 20 | 1368x6 | 10 | 145 | 10 | 6747 | 1 |
| 1360x8 | 20 | 1368x6x2 | 5 | 33806-A | 20 | 6748 | 1 |
| 1360x10 | 10 | 1368x6x6 | 5 | 33806-B | 5 | 6749 | 1 |
| 1360x12 | 10 | 1368x8 | 5 | 33806B-Y06 | 2 | FH-15X | 1 |
| 1361x6 | 20 | 1368x10 | 5 | 33806B-Y24 | 5 | FS-800 | 1 |
| 1361x8 | 5 | 1369x4x4 | 5 | 33806B-Y28 | 5 | W05465 | 5 |
| 1361x10 | 5 | 1369x6 | 10 | 33806B-Y34 | 5 | W14630 | 10 |
| 1362x4 | 5 | 1369x8 | 5 | 33806B-Y38 | 5 | W15310 | 5 |
| 1362x6 | 10 | 1380x6 | 5 | 6707 | 1 | W76150 | 5 |
| 1362x8 | 5 | 1390x6 | 5 | 6708 | 1 | W79850 | 3 |
| 1362x10 | 5 | 1391x6 | 5 | 6709 | 1 | W79851 | 3 |



AB-28 • AIR BRAKE FITTINGS ASSORTMENT

The 1/4", 3/8", 1/2" brass air brake fittings for use with copper tubing provide excellent coverage for fleets, independent repair shops and farm implement dealers doing service work.

With the AB-28 assortment you also receive a cabinet with clear plastic drawers plus illustrated, color-coded labels that assure fast, positive identification and selection of replacement fittings.

AB-28 Contents

| Catalog Number | Quantity | Catalog Number | Quantity | Catalog Number | Quantity | Catalog Number | Quantity |
|----------------|----------|----------------|----------|----------------|----------|----------------|----------|
| 1360x4 | 20 | 1361x10 | 5 | 1368x8 | 5 | 33806B-Y28 | 5 |
| 1360x6 | 20 | 1361x12 | 5 | 1369x4 | 5 | 33806B-Y34 | 5 |
| 1360x8 | 20 | 1362x6 | 5 | 1369x6 | 10 | 33806B-Y38 | 5 |
| 1360x10 | 10 | 1362x8 | 5 | 145 | 10 | CL-16-2 | 1 |
| 1360x12 | 10 | 1362x10 | 5 | 33806-A | 20 | FC-16X | 1 |
| 1361x4 | 5 | 1368x4 | 5 | 33806B-Y06 | 2 | W14630 | 10 |
| 1361x6 | 20 | 1368x6 | 10 | 33806B-Y24 | 5 | W15310 | 5 |
| 1361x8 | 5 | 1368x6x6 | 5 | | | | |



SA-1 • SECONDARY AIR SYSTEMS KIT

Ideal for fleet repair shops, truck dealers, garages and truck stops. SA-1 contains an assortment of popular 1/8" and 1/4" brass fittings plus 200' of Weatherhead NT100 SAE J844 Nylon tubing. The 1/8" fittings are Weatherhead SELFALIGN® and 1/4" fittings are Weatherhead 1400 series air brake. The sturdy box keeps the tubing and fittings together for quick and easy servicing of the tubing used on shifters, PTO's, wipers, horns, remote air, instrumentation, etc. All of the parts are organized at your finger tips. The SA-1 is a must for all vehicle air system maintenance facilities.

Size: 15" wide, 3-1/2" high, 14-1/2" deep.

| Catalog Number | Qty. | Catalog Number | Qty. |
|----------------|------|----------------|------|
| 1460x4 | 10 | 601x2 | 10 |
| 1461x4 | 5 | 611x2 | 5 |
| 1462x4 | 2 | 621x2 | 2 |
| 1464x4 | 1 | 661x2 | 2 |
| 1468x4 | 2 | 681x2 | 2 |
| 1468x4x1 | 2 | 681x2x1 | 2 |
| 1468x4x4 | 2 | 691x2 | 2 |
| 1469x4 | 2 | 691x2x1 | 2 |
| 1469x4x4 | 2 | BF-40X | 1 |
| 1484x4 | 5 | NT10002BK-100 | 100' |
| | | NT10004BK-100 | 100' |



SA-2 • SECONDARY AIR SYSTEMS KIT

The SA-2 assortment enables you to supply fleets and dealers with fittings and tubing for 1/4" and 3/8" O.D. air brake applications. 1/8" O.D. tubing and fittings are also supplied for applications such as transmission shifter, air horn, gauge and flat adjustment. A cabinet is also supplied for easy storage on shelves and bench tops.

| Catalog Number | Qty. | Catalog Number | Qty. |
|----------------|------|----------------|------|
| 1460x4 | 10 | 1468x6x2 | 5 |
| 1460x6 | 20 | 1468x6x6 | 5 |
| 1461x4 | 5 | 1468x6x8 | 5 |
| 1461x6 | 10 | 1469x4 | 5 |
| 1462x4 | 5 | 1469x4x4 | 5 |
| 1462x6 | 10 | 1469x6 | 10 |
| 1464x4 | 2 | 1469x6x6 | 5 |
| 1464x6 | 2 | 601x2 | 10 |
| 1466x6 | 5 | 611x2 | 10 |
| 1468x4 | 5 | 621x2 | 5 |
| 1468x4x4 | 5 | 661x2 | 5 |
| 1468x4x6 | 2 | 681x2 | 5 |
| 1472x4 | 5 | 681x2x1 | 2 |
| 1472x6 | 5 | 691x2 | 5 |
| 1472x6x6x6 | 5 | 691x2x1 | 2 |
| 1484x4 | 10 | BL-456-X | 1 |
| 1484x6 | 10 | FS-SA-2 | 1 |
| 1485x4 | 10 | NT10002BK-100 | 100' |
| 1485x6 | 10 | NT10004BK-100 | 100' |
| 1468x6 | 10 | NT10006BK-100 | 100' |



AB-8 & AB-9 • Air Brake Air Chamber Hose

Assembly Assortment of 3/8" and 1/2" I.D. Lines

Each selection of ready-made air chamber hose assemblies facilitates replacement of hoses. Eliminates time and cost of making special assemblies. Wall rack keeps assemblies handy and ready to use.

AB-8 • 1/2" I.D. Air Brake Air Chamber Lines

| Length | Qty. | Catalog Number | Length | Qty. | Catalog Number |
|---------|------|----------------|---------|------|----------------|
| 18-1/2" | 1 | 38353-01800 | 32" | 1 | 38353-03200 |
| 20-3/8" | 1 | 38353-02037 | 34-3/8" | 1 | 38353-03437 |
| 24-1/8" | 1 | 38353-02400 | 36-1/8" | 1 | 38353-03600 |
| 28-3/8" | 1 | 38353-02837 | 41-1/8" | 1 | 38353-04112 |
| 30-1/8" | 1 | 38353-03000 | Rack | 1 | AB-8X |

Replacement Labels **AB-8L**

AB-9 • 3/8" I.D. Lines Air Brake Air Chamber Lines

| Length | Qty. | Catalog Number | Length | Qty. | Catalog Number |
|---------|------|----------------|---------|------|----------------|
| 18-1/2" | 1 | 38166-01812 | 32" | 1 | 38166-03200 |
| 20-3/8" | 2 | 38166-02137 | 34-3/8" | 1 | 38166-03437 |
| 24-1/8" | 2 | 38166-02412 | 36-1/8" | 2 | 38166-03612 |
| 28-3/8" | 2 | 38166-02837 | 41-1/8" | 1 | 38166-04112 |
| 30-1/8" | 2 | 38166-03012 | Rack | 1 | AB-9X |

Replacement Labels **AB-9L**



CA-130 & CA-230 • Clamp Assortments

You can now increase your all-stainless steel or part-stainless steel clamp sales with these all-purpose clamp assortments. These rugged assortments can be wall mounted or stand free using less than 2 sq. ft. of counter space. They load easily and organize your merchandise effectively.

CA-130 • Part-Stainless Steel

| Catalog Number | Quantity | Catalog Number | Quantity |
|----------------|----------|----------------|----------|
| 6205-004 | 20 | 6203-024 | 10 |
| 6205-006 | 10 | 6203-036 | 10 |
| 6203-010 | 20 | CA-10X | 1 |
| 6203-016 | 20 | | |
| 6203-020 | 20 | | |

CA-230 • All-Stainless Steel

| Catalog Number | Quantity | Catalog Number | Quantity |
|----------------|----------|----------------|----------|
| 6204-010 | 20 | 6206-004 | 20 |
| 6204-016 | 20 | 6206-006 | 10 |
| 6204-020 | 20 | CA-10X | 1 |
| 6204-024 | 10 | | |
| 6204-036 | 10 | | |

RELATED PRODUCT

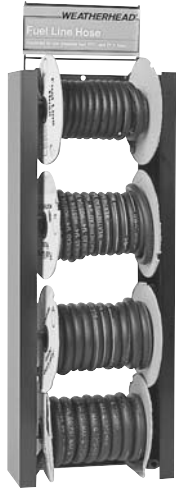

HA-574 • Fuel Hose Merchandiser

Now you can make those custom hose assemblies in minutes for instant service on fuel and oil line replacements. The attractive HA-574 includes H057 hose in all popular sizes for low pressure fuel, EEC and PCV lines. Weatherhead H057 low pressure fuel line hose has Nitrile inner tube, fiber braid reinforcement, and Hypalon cover for long life compatibility with gasohol, leaded and unleaded fuels. The HC-574X rack can be easily installed on pegboard, wall, or metal shelving with the included hardware.

| Catalog Number | Quantity | Description |
|----------------|----------|-------------|
| H05703-25R | 25' | Hose |
| H05704-25R | 25' | Hose |
| H05705-25R | 25' | Hose |
| H05706-25R | 25' | Hose |
| HC-574X | 1 | Rack |

BL-456 • Barb-Tite® Fittings and Hose Assortment

Making up an air line – oil line – transmission or power steering return line? The BL-456 assortment puts Weatherhead Barb-Tite® fittings and 1/4", 5/16", and 3/8" I.D. 350 PSI maximum operating pressure H101 hose at your fingertips for quick and easy assembly. Simply push ends on hose, and you have a hose assembly. No clamps required!

Your hose will be kept clean and easily accessible on three shelves in the cabinet. Measure the hose on top of the cabinet with the rule provided and then select the proper hose ends from the assortment in the two metal drawers. Within minutes the hose assembly is ready for installation.

Size: 15" wide, 16-1/2" high, 13-3/16" deep

16 Compartments in each drawer.



| Catalog Number | Qty. | Catalog Number | Qty. |
|----------------|------|----------------|------|
| 10004B-102 | 4 | 10004B-B04 | 4 |
| 10004B-104 | 4 | 10004B-B05 | 4 |
| 10004B-304 | 4 | 10004B-Y04 | 4 |
| 10004B-305 | 4 | 10005B-102 | 4 |
| 10004B-405 | 4 | 10005B-104 | 4 |
| 10004B-604 | 4 | 10005B-405 | 4 |
| 10004B-A04 | 4 | 10005B-B05 | 4 |
| 10004B-A05 | 4 | 10005B-B06 | 4 |
| 10004B-B03 | 4 | | |
| Catalog Number | Qty. | Catalog Number | Qty. |
| 10005B-C02 | 4 | 10006B-606 | 4 |
| 10005B-C04 | 4 | 10006B-B06 | 4 |
| 10005B-Y05 | 4 | 10006B-Y06 | 4 |
| 10006B-102 | 4 | BL-456X | 1 |
| 10006B-104 | 4 | FS-501 | 1 |
| 10006B-106 | 4 | H10104 | 50' |
| 10006B-306 | 4 | H10105 | 50' |
| 10006B-406 | 4 | H10106 | 50' |

These assortments are ideal for servicing that fleet account. The D.O.T. approved hose and fittings will enable the user to make up chamber lines, connect to gladhand couplings, and provide routing for air brake lines. The general purpose H069 provides for fuel, oil, water, power steering, and transmission lines. A self-contained assortment in a super cabinet, all set up for easy serviceability!



FA-100 • Fleet Hose and Fitting Assortment

| Catalog Number | Qty | Catalog Number | Qty | Catalog Number | Qty |
|----------------|-----|----------------|-----|----------------|-----|
| 24704N-102 | 5 | 24706N-B06 | 5 | 33806B-Y28 | 5 |
| 24704N-104 | 5 | 24708N-106 | 5 | 33806B-Y34 | 5 |
| 24704N-604 | 5 | 24708N-108 | 5 | 33806B-Y36 | 5 |
| 24704N-B04 | 5 | 24708N-406 | 5 | 33806B-Y38 | 5 |
| 24705N-104 | 5 | 24708N-608 | 5 | FH-15X | 1 |
| 24705N-605 | 5 | 24710B-Y58 | 2 | H06904 | 50' |
| 24705N-B05 | 5 | 24710B-Y60 | 5 | H06906 | 50' |
| 24706N-104 | 5 | 24710N-108 | 5 | H06908 | 50' |
| 24706N-106 | 5 | 24710N-608 | 5 | H06910 | 50' |
| 24706N-406 | 5 | 24710N-610 | 2 | H16606 | 50' |
| 24706N-604 | 5 | 33806-A | 20 | H16608 | 50' |
| 24706N-605 | 5 | 33806-B | 5 | H33806 | 50' |
| 24706N-606 | 5 | 33806B-Y06 | 5 | HD-1X | 1 |
| 24706N-608 | 5 | 33806B-Y24 | 5 | | |
| 24706N-756 | 5 | 33806B-Y26 | 2 | | |

FA-100-CO • Fleet Hose and Fitting Assortment (Contents Only)

| Catalog Number | Qty | Catalog Number | Qty | Catalog Number | Qty |
|----------------|-----|----------------|-----|----------------|-----|
| 24704N-102 | 5 | 24706N-756 | 5 | 33806B-Y24 | 5 |
| 24704N-104 | 5 | 24706N-B06 | 5 | 33806B-Y26 | 2 |
| 24704N-604 | 5 | 24708N-106 | 5 | 33806B-Y28 | 5 |
| 24704N-B04 | 5 | 24708N-108 | 5 | 33806B-Y34 | 5 |
| 24705N-104 | 5 | 24708N-406 | 5 | 33806B-Y36 | 5 |
| 24705N-605 | 5 | 24708N-608 | 5 | 33806B-Y38 | 5 |
| 24705N-B05 | 5 | 24710B-Y58 | 2 | H06904 | 50' |
| 24706N-104 | 5 | 24710B-Y60 | 5 | H06906 | 50' |
| 24706N-106 | 5 | 24710N-108 | 5 | H06908 | 50' |
| 24706N-406 | 5 | 24710N-608 | 5 | H06910 | 50' |
| 24706N-604 | 5 | 24710N-610 | 2 | H16606 | 50' |
| 24706N-605 | 5 | 33806-A | 20 | H16608 | 50' |
| 24706N-606 | 5 | 33806-B | 5 | H33806 | 50' |
| 24706N-608 | 5 | 33806B-Y06 | 5 | | |

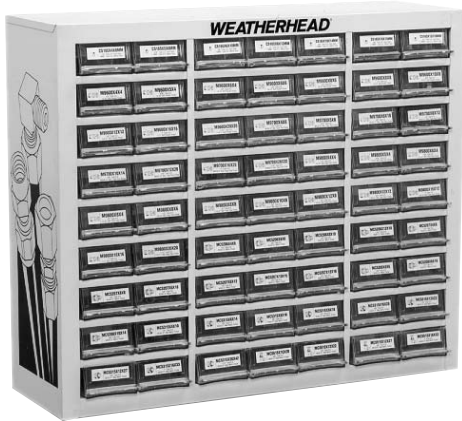

MA-100 • Metric Adapter Assortment

The MA-100 is an ideal assortment to begin a metric adapter inventory. Offered are a variety of male British Standard Tapered Pipe and British Standard Parallel fittings in straight and 90° elbow configurations, sizes ranging from 1/8" through 1-1/4". Two male DIN (German metric) fittings adapt SAE fittings and hose ends to metric size tubing, and a third DIN fitting connects SAE fittings with metric female swivel adapters, sizes ranging from 6mm through 42mm. The C5165X metric sleeves adapt metric tubing used with standard JIC fittings. The MA-100 is supplied with cabinet for accurate and easy access to your metric fittings.

Replacement Drawers: **PD-49** (Individual)
 Replacement Dividers: **PD-75 Set** (25/set)

MA-100 Contents

| Catalog Number | Qty. | Catalog Number | Qty. | Catalog Number | Qty. | Catalog Number | Qty. | Catalog Number | Qty. |
|----------------|------|----------------|------|----------------|------|----------------|------|----------------|------|
| 7165X6MM | 5 | M9700X5X8 | 2 | MB5515X6X4 | 5 | MC5208X6X6 | 2 | MH7105X6 | 5 |
| 7165X8MM | 2 | M9700X6X10 | 2 | MB5515X6X6 | 5 | MC5208X8X10 | 2 | MH7105X8 | 5 |
| 7165X10MM | 5 | M9700X8X12 | 2 | MB5515X8X6 | 5 | MC5208X10X14 | 2 | MH7105X10 | 5 |
| 7165X12MM | 5 | M9700X10X14 | 2 | MB5515X8X8 | 5 | MC5208X12X16 | 2 | MH7105X12 | 5 |
| 7165X14MM | 5 | M9700X12X20 | 2 | MB5515X10X12 | 5 | MC5315X4X10 | 2 | MH7105X14 | 5 |
| 7165X15MM | 5 | M9700X16X25 | 2 | MB5515X12X12 | 5 | MC5315X4X12 | 2 | MH7105X16 | 5 |
| 7165X16MM | 5 | M9700X20X32 | 1 | MB5515X16X16 | 2 | MC5315X6X14 | 2 | MH7105X20 | 5 |
| 7165X18MM | 5 | M9800X4X4 | 2 | MB5515X20X20 | 2 | MC5315X6X16 | 2 | MH7105X25 | 5 |
| 7165X20MM | 5 | M9800X5X4 | 2 | MC5205X4X2 | 5 | MC5315X8X18 | 2 | MH7105X30 | 5 |
| 7165X22MM | 5 | M9800X6X4 | 2 | MC5205X4X4 | 5 | MC5315X10X20 | 2 | ML7105X6 | 5 |
| 7165X25MM | 5 | M9800X8X4 | 2 | MC5205X5X4 | 5 | MC5315X12X22 | 2 | ML7105X8 | 5 |
| 7165X28MM | 5 | M9800X8X6 | 2 | MC5205X6X4 | 5 | MC5315X12X27 | 2 | ML7105X10 | 5 |
| 7165X30MM | 5 | M9800X8X8 | 2 | MC5205X6X6 | 5 | MC5315X16X33 | 2 | ML7105X12 | 5 |
| M7629X10 | 5 | M9800X10X8 | 2 | MC5205X8X6 | 5 | MC5315X20X42 | 1 | ML7105X15 | 5 |
| M7629X14 | 5 | M9800X12X8 | 2 | MC5205X8X8 | 5 | MC5405X4X4 | 5 | ML7105X18 | 5 |
| M7629X16 | 5 | M9800X12X12 | 2 | MC5205X10X8 | 5 | MC5405X5X4 | 5 | ML7105X22 | 5 |
| M7629X18 | 5 | M9800X16X12 | 2 | MC5205X10X12 | 5 | MC5405X6X4 | 5 | ML7105X28 | 5 |
| M7629X20 | 5 | M9800X16X16 | 2 | MC5205X12X12 | 5 | MC5405X6X6 | 5 | C5165X4X6MM | 5 |
| M7629X22 | 5 | M9800X20X20 | 1 | MC5205X16X16 | 2 | MC5405X8X6 | 5 | C5165X5X8MM | 5 |
| M7629X27 | 5 | MB5315X4X2 | 5 | MC5205X20X20 | 2 | MC5405X8X8 | 5 | C5165X6X10MM | 5 |
| M7629X33 | 5 | MB5315X4X4 | 5 | MC5206X4X6 | 2 | MC5405X10X12 | 5 | C5165X8X12MM | 5 |
| M7629X42 | 5 | MB5315X5X4 | 5 | MC5206X6X8 | 2 | MC5405X12X12 | 5 | C5165X10X14MM | 5 |
| M9600X4X4 | 2 | MB5315X6X4 | 5 | MC5206X8X10 | 2 | MC5405X16X16 | 2 | C5165X10X15MM | 5 |
| M9600X5X4 | 2 | MB5315X6X6 | 5 | MC5206X8X12 | 2 | MC5405X20X20 | 2 | C5165X10X16MM | 5 |
| M9600X6X4 | 2 | MB5315X8X6 | 5 | MC5206X10X15 | 2 | MC5515X4X12 | 2 | C5165X12X18MM | 5 |
| M9600X6X6 | 2 | MB5315X8X8 | 5 | MC5206X12X18 | 2 | MC5515X6X14 | 2 | C5165X14X20MM | 5 |
| M9600X8X6 | 2 | MB5315X10X12 | 5 | MC5207X4X6 | 2 | MC5515X6X16 | 2 | C5165X16X25MM | 5 |
| M9600X8X8 | 2 | MB5315X12X12 | 5 | MC5207X6X8 | 2 | MC5515X8X18 | 2 | C5165X20X30MM | 5 |
| M9600X10X8 | 2 | MB5315X16X16 | 2 | MC5207X6X10 | 2 | MC5515X10X20 | 2 | C5165X20X32MM | 5 |
| M9600X12X12 | 2 | MB5315X20X20 | 2 | MC5207X8X12 | 2 | MC5515X12X22 | 2 | C-5X | 1 |
| M9600X16X16 | 2 | MB5515X4X4 | 5 | MC5207X10X15 | 2 | MC5515X12X27 | 2 | C-63X | 1 |
| M9600X20X20 | 1 | MB5515X5X4 | 5 | MC5207X12X18 | 2 | MC5515X16X33 | 1 | CL-502 | 1 |
| M9700X4X6 | 2 | | | | | | | TA-1002 | 1 |



MA-200 • Metric Hose End Assortment

The MA-200 Hose End Assortment offers an excellent introductory stock of metric hose ends. Coverage includes 'U' Series British Standard Tapered Pipe (BSPT) and British Standard Parallel Pipe (BSPP) in male straight, and female swivel in straight and 90° tube elbow connections, swivels, and split flange ends for Komatsu and Link Belt applications and DIN standpipe hose ends in light and heavy series. One FH-15X stock cabinet is supplied for storage.

MA-200 Contents

| Catalog Number | Qty. | Catalog Number | Qty. | Catalog Number | Qty. | Catalog Number | Qty. | Catalog Number | Qty. |
|----------------|------|----------------|------|----------------|------|----------------|------|----------------|------|
| 04U-14K | 2 | 06U-76P | 2 | 12U-162 | 2 | 16U-P66 | 2 | MH7105X14 | 2 |
| 04U-154 | 5 | 08U-158 | 5 | 12U-30K | 2 | 7165X8MM | 5 | MH7105X16 | 2 |
| 04U-354 | 5 | 08U-22K | 2 | 12U-362 | 2 | 7165X10MM | 4 | MH7105X20 | 2 |
| 04U-38T | 2 | 08U-358 | 5 | 12U-52T | 2 | 7165X12MM | 2 | MH7105X25 | 2 |
| 04U-40T | 2 | 08U-360 | 5 | 12U-55T | 2 | 7165X14MM | 2 | MH7105X30 | 1 |
| 04U-P54 | 5 | 08U-45T | 2 | 12U-G12 | 2 | 7165X15MM | 2 | ML7105X8 | 2 |
| 04U-74P | 2 | 08U-46T | 2 | 12U-G42 | 2 | 7165X16MM | 2 | ML7105X10 | 2 |
| 06U-156 | 5 | 08U-P56 | 2 | 12U-P62 | 2 | 7165X18MM | 2 | ML7105X12 | 2 |
| 06U-18K | 2 | 08U-P58 | 2 | 12U-82P | 2 | 7165X20MM | 2 | ML7105X15 | 2 |
| 06U-356 | 5 | 08U-78P | 2 | 16U-166 | 2 | 7165X22MM | 2 | ML7105X18 | 2 |
| 06U-358 | 2 | 08U-80P | 5 | 16U-33K | 2 | 7165X25MM | 2 | ML7105X22 | 2 |
| 06U-40T | 2 | 10U-24K | 2 | 16U-366 | 2 | 7165X28MM | 2 | ML7105X28 | 2 |
| 06U-42T | 2 | 10U-48T | 2 | 16U-58T | 2 | 7165X30MM | 1 | FH-15X | 2 |
| 06U-44T | 2 | 10U-50T | 2 | 16U-60T | 1 | MH7105X8 | 2 | FS-2500 | 1 |
| 06U-P56 | 2 | 10U-G09 | 2 | 16U-G16 | 2 | MH7105X10 | 2 | | |
| 06U-P58 | 2 | 10U-G69 | 2 | 16U-G46 | 2 | MH7105X12 | 2 | | |



FL-310 • Fuel Hose and Fittings Assortment

FL-310 contains 250' of Weatherhead fuel line hose, a variety of brass hose end fittings, and gear-type clamps for easy, instant service on fuel and oil line assemblies.

A well-designed cabinet keeps 1/4", 5/16", 3/8", or 7/16" I.D. hose on reels free of kinks and tangles...ready for instant use. Ten clear plastic drawers with color-coded illustrated labels are provided for storing hose end fittings and clamps. H057 hose is compatible with unleaded gasolines and low pressure fuel systems.

Size: 30" wide, 13-1/2" high, 13" deep

| Catalog No. | Qty. | Catalog No. | Qty. | Catalog No. | Qty. |
|-------------|------|-------------|------|-------------|------|
| 05704B-102 | 10 | 05705B-C04 | 5 | 6202 | 20 |
| 05704B-104 | 5 | 05706B-102 | 10 | CL-434 | 1 |
| 05704B-C02 | 5 | 05706B-104 | 10 | FL-310X | 1 |
| 05705B-102 | 10 | 05706B-106 | 5 | H05704-100R | 100' |
| 05705B-104 | 10 | 05706B-1568 | 5 | H05705-100R | 100' |
| 05705B-1560 | 5 | 05706B-1570 | 5 | H05706-100R | 50' |
| 05705B-1561 | 5 | 05706B-C02 | 5 | | |
| 05705B-C02 | 5 | 05706B-C04 | 5 | | |

RELATED PRODUCT