

Weatherly Index 630-5
Catalog No. E-BRFI-MC001-E2
Dated February 2007

EAT•N

Brass Products Master Catalog

Product Focus



Table of Contents

Weatherly Index 630-5
Catalog No. E-BRFI-MC001-E2
Dated February 2007

Application Data

Important Safety Information	1
Visual Index	2
Numbering Systems	8
Tube Connector Selector Chart	9
Thread Identification	10
Tubing Selection	15
Flare Dimensions	19
Tubing Installation	21
Chemical Compatibility Chart	22

Tubing

Plastic Tubing	27
----------------	----

Brass Products

Introduction	30
Inverted Flare	31
SAE 45° Flare	36
Compression	41
Selfalign™	47
Polyline™ Flareless	53
Push>Connect™	57
Push>Connect Metric	64
Push>Connect Flow Controls	68
Push>Connect Plus	70
Mini-Barb	72
Quick>Connect™ Air Brake	76
Air Brake Products for Nylon Tubing	84
Air Brake Products for Copper Tubing	90
Threaded Sleeve	95
Pipe	97
Needle Valves	103
Drain Cocks	107
Truck Valves	110
Plastic Drain Cocks	111
Ground Plug & Multiple Shut-Offs	112
Brass Ball Valves	115
Special Adapter	119
Hydraulic Brake Products	123
Steel Brake Lines	125

Plastic Products

Molded Compression Tube Products	126
Plastic Products	134

Brass – Nickel Plated

BSPP Products	135
---------------	-----

Related Products

Air Brake Products & Measuring Kits	136
Assembly & Tool Cutting Equipment	137
Tube Cutting Equipment	138
Tube Bending Tools	139
Tube Flaring & Brazing Tools	140
Label Sets & Bags	141
Cabinets & Assortments	142

Certification

ISO & QS Certifications	146
-------------------------	-----

Conversion

Conversion Charts	147
-------------------	-----

Glossary

Alpha/Numeric index	149
---------------------	-----

Index

Alpha/Numeric Index	152
---------------------	-----

Warranty

Eaton Warranty	156
----------------	-----

Application Data

Important Safety Information



Selection of Tubing

Selecting the proper tubing for a given application is essential to the proper operation and safe use of the tubing and related equipment. Inadequate attention to the selection of the tubing for your application can result in leakage, bursting, or other failure which can cause serious bodily injury or property damage from spraying fluids or flying projectiles. In order to avoid serious bodily injury or property damage resulting from selection of the wrong tubing, you should carefully review the information in this catalog. Some of the factors that are involved in the selection of the proper tubing are:

- material of tubing
- bends
- tubing size
- temperature
- tubing length
- tubing pressure rating
- tubing end connections
- installation design
- fluid conveyed (compatibility)

These factors and the other information in this catalog should be considered by you in selecting the proper tubing for your application. If you have any questions regarding the proper tubing for your application, please contact Eaton Technical Support 1-888-258-0222.

Proper Selection of Tube Fittings

Selection of the proper Eaton tube products for the application is essential to the proper operation and safe use of tubing and related equipment. Inadequate attention to the selection of the products for your application can result in tube leakage, bursting, or other failure which can cause serious injury or property damage from spraying fluids or flying projectiles. In order to avoid serious bodily injury or property damage resulting from selection of the wrong tube end fitting, you should carefully review the information in this catalog. Some of the factors which are involved in the selection of the proper products are:

- tube end connections
- installation design
- compatibility with tubing
- tubing size
- temperature
- corrosion requirements

These factors and the other information in this catalog should be considered by you in selecting the proper tube ends for your application.

If you have any questions regarding the proper tube ends for your application, please contact Eaton Technical Support at 1-888-258-0222.

Tubing Installation

Proper installation of the tubing is essential to the proper operation and safe use of the tubing and related equipment. Improper installation of the tubing can result in serious injury or property damage. In order to avoid serious bodily injury or property damage resulting from improper installation of the tubing, you should carefully review the information in this catalog regarding tubing installation.

Some of the factors you must consider in installing the tubing properly are:

- proper installation procedures
- changes in length
- protection from high temperature sources
- twisting
- stress
- rubbing and abrasion

These factors and other information in this catalog regarding tubing installation should be considered by you before installing the tubing.

If you have any questions regarding proper installation of the tubing, please contact Eaton Technical Support 1-888-258-0222.

Tubing Assembly

Changes in materials, finishes, and assembly techniques may affect the sealing or holding capability of the joint. Due to the great variety of possible assembly scenarios, assembly procedures should be tested to determine if the joint is adequate for its intended use. Improper assembly or overtightening could result in leakage, tubing separation or other failures which could cause serious bodily injury or property damage from spraying fluids or flying projectiles.

These factors and other information in this catalog regarding tubing assembly should be considered by you before installing the tubing.

If you have any questions regarding proper assembly and installation of the tubing, please contact Eaton Technical Support 1-888-258-0222.









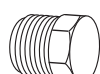
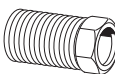

Dimensions

Dimensions given in this catalog are approximate and should be used for reference only. Exact dimensional information for a given product is subject to change and varying tolerances. Check with Eaton Technical Support at 1-888-258-0222 for critical applications.

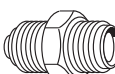
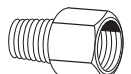
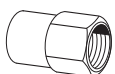

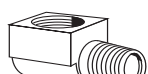

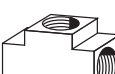
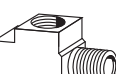

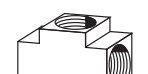





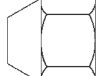
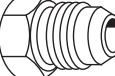
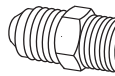
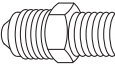

Application Data

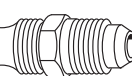
Visual Index





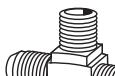





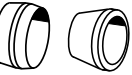

Inverted Flare

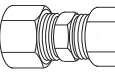
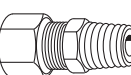
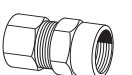
Tube Nut (Steel)  105x pg. 32	Tube Nut (Brass)  100x pg. 32	Plug (Steel)  131x pg. 32	Tube Nut Long (Steel)  7896x pg. 32	Union  252x pg. 32	Adapter SAE 45° Flare to Inv. Flare  pg. 33
Male Connector  202x pg. 33	Female Connector  252x pg. 33	45° Male Elbow  352x pg. 33	Union Elbow  502x pg. 34	Male Elbow  402x pg. 34	
Female Elbow  452x pg. 34	Union Tee  702x pg. 35	Male Run Tee  752x pg. 35	Male Branch Tee  602x pg. 35	Female Branch Tee  652x pg. 35	

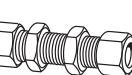
SAE 45° Flare

Nut  1110x pg. 37	Long Nut  41x pg. 37	Cap  40x pg. 37	Plug  39x pg. 37	Union  42x pg. 37	Male Connector  48x pg. 38
Female Connector  46x pg. 38	Male Ball Check Connector  43x pg. 38	45° Male Elbow  54x pg. 38	AC Type Adapter  pg. 39	Adapter SAE 45° Flare to Inv. Flare  pg. 39	Union Elbow  55x pg. 39
Male Elbow  49x pg. 39	Female Elbow  50x pg. 39	Union Tee  44x pg. 40	Male Run Tee  51x pg. 40	Male Branch Tee  45x pg. 40	Adapter Tee  56x pg. 40

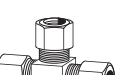

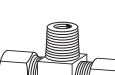
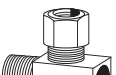



Compression and SelfAlign Products

Tube Support for Plastic Tubing  2030x pg. 42	Sleeve  60x pg. 42 601x pg. 42	Nut  61x pg. 42 611x pg. 49	Long Nut  1611x pg. 43	Bulkhead Nut  0102x pg. 43	Union  62x pg. 43 621x pg. 43
Male Connector  68x pg. 43 681x pg. 50	Female Connector  66x pg. 44 661x pg. 50	Male Ball Check Connector  63x pg. 44 631x pg. 50	Bulkhead Union  74x pg. 44 741x pg. 51	Male Elbow  69x pg. 45 691x pg. 51	Union Elbow  65x pg. 45 651x pg. 51
Female Elbow  70x pg. 45 701x pg. 51	Union Tee  64x pg. 46 641x pg. 52	Male Run Tee  71x pg. 46 711x pg. 52	Male Branch Tee  72x pg. 46 721x pg. 52	Adapter Tee  76x pg. 46	





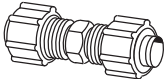

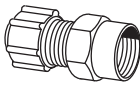
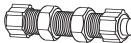
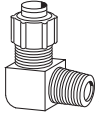
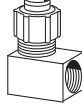
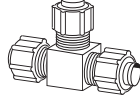
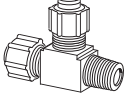
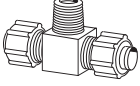

Application Data

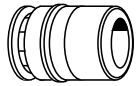
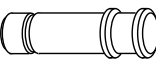
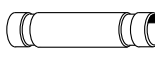
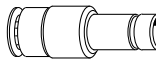
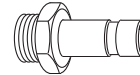
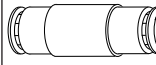
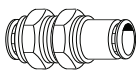
Visual Index

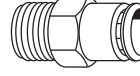
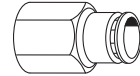
Polyline Flareless



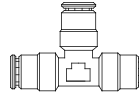
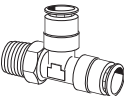
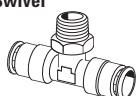
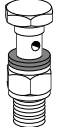

Plastic Sleeve  1260x pg. 54	Brass Nut  1261x pg. 54	Brass Nut/Plastic Sleeve Assembly  1261x-Ax pg. 54	Brass Bulkhead Nut  1202x-A pg. 54	Union  1262x pg. 54	Male Connector  1268x pg. 55
Female Connector  1266x pg. 55	Bulkhead Union  1274x pg. 55	Male Elbow  1269x pg. 56	Female Elbow  1270x pg. 56	Union Tee  1264x pg. 56	Male Run Tee  1271x pg. 56
Male Branch Tee  1272x pg. 56					

Push>Connect

Cartridge  Metric 1161x pg. 64 pg. 59	Plug (Plastic)  Metric 1129x pg. 64 pg. 59	Double Union  Metric 1105x pg. 64 pg. 59	Reducer  Metric 1109x pg. 64 pg. 59	Stem Adapter  Metric 1180x pg. 64 pg. 60	Union  Metric 1612x pg. 64 pg. 60
Bulkhead Union  Metric 1174x pg. 65 pg. 60	Union "Y"  Metric 1107x pg. 65 pg. 60	Male "Y"  Metric 1108x pg. 65 pg. 61	Male Connector  Metric 1168x pg. 65 pg. 61	Female Connector  Metric 1166x pg. 65 pg. 61	Union Elbow  Metric 1165x pg. 66 pg. 61
Swivel Male Elbow  Metric 1169x-S pg. 66 pg. 62	Male Elbow  Metric 1169x pg. 66 pg. 62	Union Tee  Metric 1164x pg. 67 pg. 62	Male Run Tee Swivel  Metric 1171x-S pg. 67 pg. 62	Male Branch Tee Swivel  1168x pg. 67 pg. 63	Stud Manifolds  pg. 63
Banjos  pg. 63	Flow Controls  pg. 69				

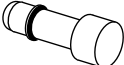
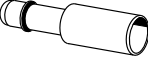
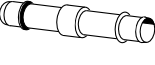
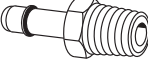
Push > Connect Plus see page 70.

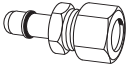
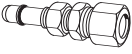

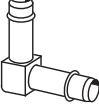
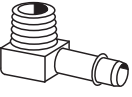
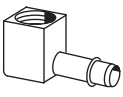
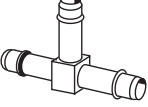
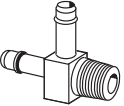
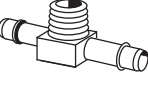
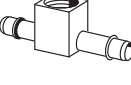
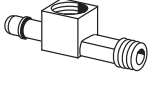



Mini-Barb

Plug  1073x pg. 73	Solder Connector  1079x pg. 73	Union  1062x pg. 73	Male Connector  1068x pg. 73	Female Connector  1066x pg. 73	Compression Connector  1078x pg. 73
Bulkhead Compression Connector  1067x pg. 74	Bulkhead Union  1074x pg. 74	Union Elbow  1065x pg. 74	90° Male Elbow  1069x pg. 74	90° Female Elbow  1070x pg. 74	Union Tee  1064x pg. 75
Male Run Tee  1071x pg. 75	Male Branch Tee  1072x pg. 75	Female Branch Tee  1077x pg. 75	Adapter Tee  1075x pg. 75		

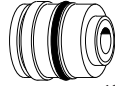
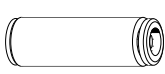
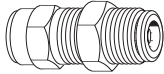

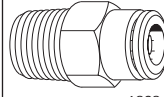

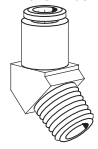
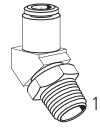
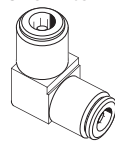
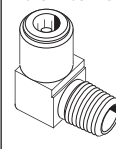
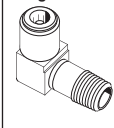
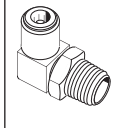
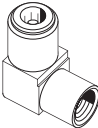
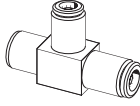
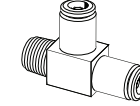
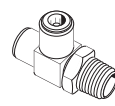
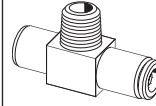
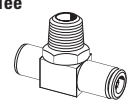

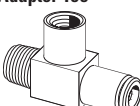
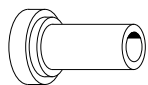

Application Data

Visual Index

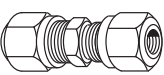
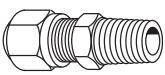
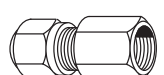
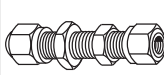
Quick>Connect Air Brake

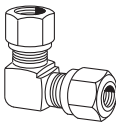
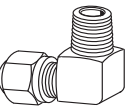
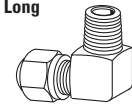
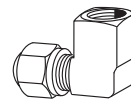
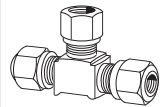
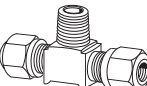
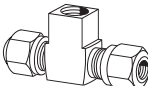
Encapsulated Cartridge  1861x pg. 78	Union  1862x pg. 78	Bulkhead Union  1874x pg. 78	Female Bulkhead Union  1873x pg. 78	Male Connector  1868x pg. 79	Female Connector  1866x pg. 79
45° Male Elbow  1880x pg. 79	Swivel Male 45° Elbow  1880x-S pg. 80	Union Elbow  1865x pg. 80	Male Elbow 90°  1869x pg. 80	Male Elbow 90° Long  1869x-L pg. 80	Swivel Male 90° Elbow  1869x-S pg. 81
Female Elbow  1870x pg. 81	Union Tee  1864x pg. 81	Male Run Tee  1871x pg. 81	Swivel Male Run Tee  1871x-S pg. 82	Male Branch Tee  1872x pg. 82	Swivel Male Branch Tee  1872x-S pg. 82
Female Branch Tee  1877x pg. 82	Adapter Tee  1883x pg. 83	Pressure Plug  1829x pg. 83			

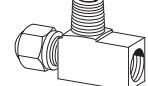
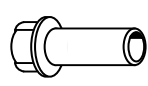



Air Brake Connectors for Nylon Tubing

Sleeve  1460x pg. 85	Nut  1461x pg. 85	Union  1462x pg. 85	Male Connector  1468x pg. 86	Female Connector  1466x pg. 86	Bulkhead Union  1474x pg. 86
45° Male Elbow  1480x pg. 86	Union Elbow  1465x pg. 87	90° Male Elbow  1469x pg. 87	90° Male Elbow Long  1469x-L pg. 87	90° Female Elbow  1470x pg. 87	Union Tee  1464x pg. 88
Male Branch Tee  1472x pg. 88	Female Branch Tee  1477x pg. 88	Male Run Tee  1471x pg. 88	Adapter Tee  1482x pg. 89	Insert  1484x pg. 89	Gauge Ring  1485x pg. 89

Application Data

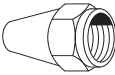
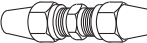
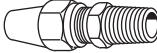
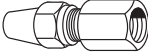
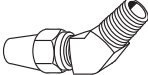
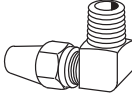
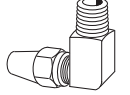
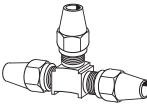
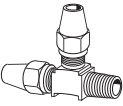
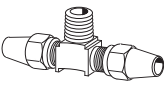
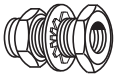
Visual Index

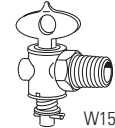





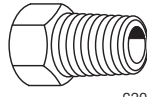
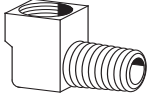

Air Brake Connectors for Copper Tubing

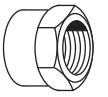
Sleeve  1360x pg. 91	Nut  1361x pg. 91	Union  1362x pg. 91	Male Connector  1368x pg. 91	Female Connector  1366x pg. 92	45° Male Elbow  1380x pg. 92
90° Male Elbow  1369x pg. 92	90° Male Elbow Long  1369x-L pg. 92	Union Tee  1364x pg. 93	Male Run Tee  1371x pg. 93	Male Branch Tee  1372x pg. 93	Bulkhead Coupling (brass)  pg. 93
Bulkhead Coupling (brass)  pg. 94	Bulkhead Coupling (brass)  pg. 94	Drain Cock  W15310 pg. 94	Shut-Off Valve  W2033L pg. 94	External Seat Draincock  145 pg. 94	

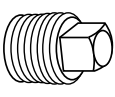
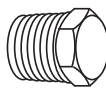
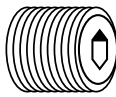
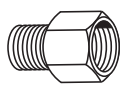
Threaded Sleeve

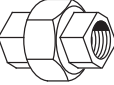
Nut  6100x pg. 96	Male Connector  6200x pg. 96	Male Elbow  6400x pg. 96
--------------------------------------------------------------------------------------------------------------------	-------------------------------------------------------------------------------------------------------------------------------	----------------------------------------------------------------------------------------------------------------------------

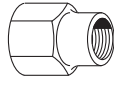
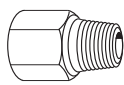
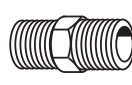
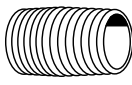
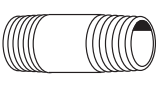
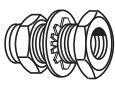
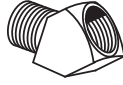

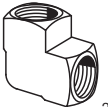
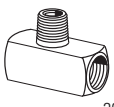
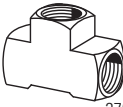
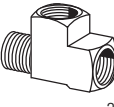
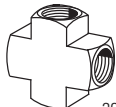



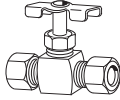
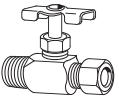

Pipe

Cap  3129x pg. 98	Slotted Plug  3150x pg. 98	Square Head Plug  3151x pg. 98	Hex Head Plug  3152x pg. 98	Hex Socket Plug  3153x pg. 98	Adapter  3200x pg. 98
Bushing  3220x pg. 99	Union  3250x pg. 99	Coupling  3300x pg. 99	Reducer Coupling  3300x pg. 99	Restriction Pipe Adapter  pg. 99	Hex Nipple  3325x pg. 100
Close Nipple  3326x pg. 100	Long Nipple  3311x pg. 100	Bulkhead Coupling (brass)  pg. 101	45° Street Elbow  3350x pg. 101	90° Street Elbow  3400x pg. 101	
90° Elbow  3500x pg. 102	Male Branch Tee  3600x pg. 102	Tee  3700x pg. 102	Male Run Tee  3750x pg. 102	Cross  3950x pg. 102	



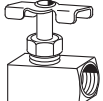

Application Data

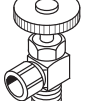
Visual Index

Needle Valves

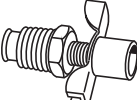
Compression Double  pg. 104	Compression Straightway  pg. 104	Compression Angle  pg. 104	Inverted Straightway  pg. 104	Male Pipe Double  pg. 105	Male to Female Pipe  pg. 105
Female Pipe  pg. 105	SAE 45° Flare Double  pg. 105	SAE 45° Flare Straightway  pg. 106	SAE 45° Flare Angle  pg. 106	Polyline Straightway  pg. 106	Poly Angle  pg. 106

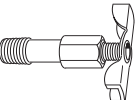
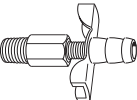
Drain Cocks

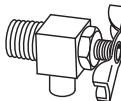
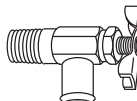
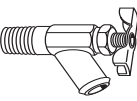
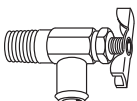
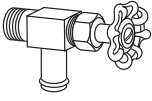
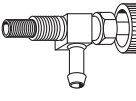
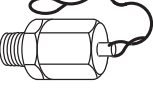
External Seat  pg. 107	External Seat  pg. 107	Internal Seat  pg. 107	Internal Seat (long)  pg. 107	Internal Seat  pg. 108	Internal Seat Drain Valve  pg. 108
Air Vent  pg. 108	Angle Bib Drain  pg. 108	Angle Bib Drain  pg. 108	Hose to Pipe (steel)  pg. 109	Hose to Pipe (steel)  pg. 109	Pipe to Hose Shut-Off  pg. 109
Gasoline Shut-Off  pg. 109	Air Tank Drain Valve  pg. 109				



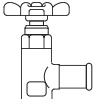
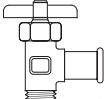
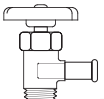
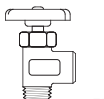
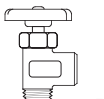



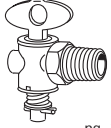
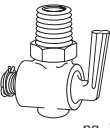
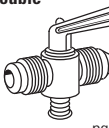
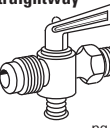
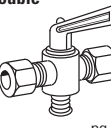
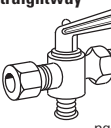
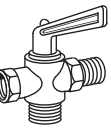

Truck Valves

Truck Valve  7502 pg. 110	Truck Valve  7504 pg. 110	Truck Valve  7506 pg. 110	Truck Valve  7508 pg. 110	Truck Valve  7509 pg. 110
------------------------------------------------------------------------------------------------------------------------------	------------------------------------------------------------------------------------------------------------------------------	------------------------------------------------------------------------------------------------------------------------------	-------------------------------------------------------------------------------------------------------------------------------	--------------------------------------------------------------------------------------------------------------------------------

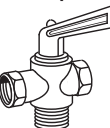
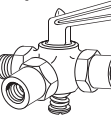

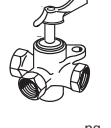
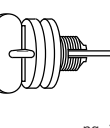

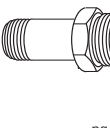
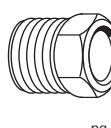









Application Data

Visual Index

Ground Plug & Multiple Shut-Offs

Draincock  pg. 112	Ground Plug Drain  pg. 112	SAE 45° Flare Double  pg. 112	SAE 45° Flare Straightway  pg. 113	Compression Double  pg. 113	Compression Straightway  pg. 113
Male to Female Pipe  pg. 113	Truck Shut-Off to Female Pipe  pg. 113	Marine Shut-Off Male to Female Pipe  pg. 114	Female Pipe  pg. 114	3-Way Shut-Off  pg. 114	3-Way Multiple Shut-Off  pg. 114
4-Way Multiple Shut-Off  pg. 114	Plastic Drain Cocks  pg. 111	Brass Ball Valves  pg. 115	Special Adapters  pg. 119	Hydraulic Brake Products  pg. 123	BSPP Products  pg. 135

Molded Compression Tube Fittings

Male Connector  1568x pg. 128	Union Connector  1562x pg. 128	Bulkhead Union  1574x pg. 129	Female Connector  1566x pg. 129	Male Elbow  1569x pg. 130	Female Elbow  1570x pg. 130
Union Elbow  1565x pg. 131	Male Branch Tee  1572x pg. 131	Union Tee  1564x pg. 131	Male Run Tee  1571x pg. 132	Compression Nut  1561x pg. 132	Insert  1584x pg. 132
Cap Nut  1529x pg. 133	Bulkhead Nut  1502x pg. 133	Kynar Check Valve  1531x pg. 133			

Plastic Barbed Fittings

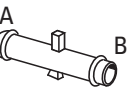
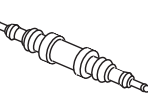
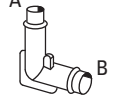
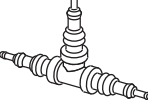
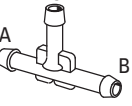
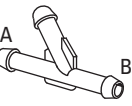
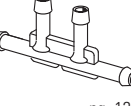
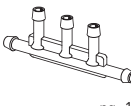
Straight Connector  pg. 134	Universal Connector  pg. 134	Elbow Connector  pg. 134	Universal Tee  pg. 134	3 Way T  pg. 134	Y Connector  pg. 134
4 Way Tee  pg. 134	5 Way Tee  pg. 134				

Application Data

Numbering Systems

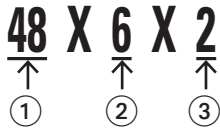
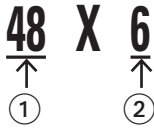

Parts in this catalog are identified by a series of numbers separated by the letter "X."

1. The number preceding the "X" is the Catalog "Base Number" and indicates the type of connector. See Table 1 below for additional base number data (sometimes referred to as dash size).
2. The second number is the tube and/or pipe size in sixteenths of an inch. When a pipe thread follows the SAE standard as shown in Table 2, no other number is required. Example: 48X6 = SAE 45° Flare Male Connector-3/8" tube, 1/4" Male Pipe.
3. If the pipe size is not to the SAE standard, another "X" is added followed by the pipe size indicated in sixteenths of an inch. Example: 1/8" is equal to 2/16" or X2 suffix.

In designating tube and pipe sizes for tees and crosses that are not SAE standard, indicate the sizes in the sequence shown.

Table 1

TYPE	EXAMPLE MALE CONNECTOR	EXAMPLE FEMALE CONNECTOR
45° Flare	48	46
Compression	68	66
Polyline	1268	1266
Selfalign	681	661
Air Brake (Nylon)	1468	1466
Air Brake (Copper)	1368	1366

Table 2

	TUBE SIZE	PIPE THREADS
X2	1/8"	1/8"
X3	3/16"	1/8"
X4	1/4"	1/8"
X5	5/16"	1/8"
X6	3/8"	1/4"
X7	7/16"	1/4"
X8	1/2"	3/8"
X10	5/8"	1/2"
X12	3/4"	1/2"
X14	7/8"	3/4"
X16	1"	1"
X20	1-1/4"	No Standard
X24	1-1/2"	No Standard
X32	2"	No Standard

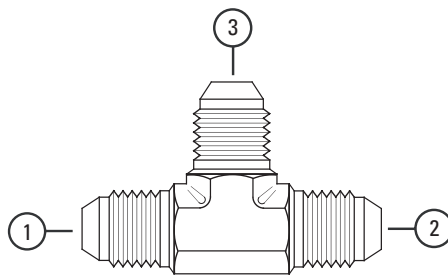

Tee

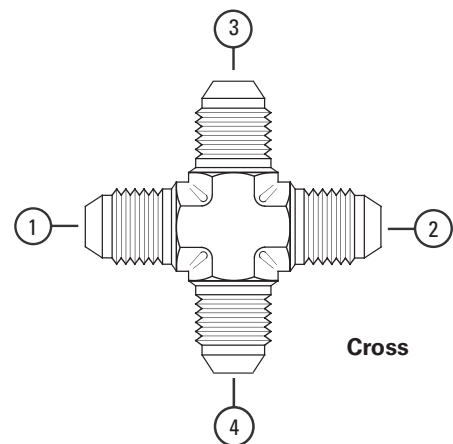

Cross

Application Data

Tube Connector Selector Chart

 Refer to safety information regarding proper selection of tubing and tube connectors on page 1.

Connector Types	Mini-Barb	Polyline	Threaded Sleeve	Pipe	Inverted Flare	SAE 45° Flare	Compression	Selfalign	1400 Series Air Brake	1300 Series Air Brake	Push> Connect	Q-CAB®	Molded Compression
Material	Brass	Brass	Brass	Brass	Brass	Brass	Brass	Brass	Brass	Brass	Brass	Brass	Nylon Poly
Tube Size	1/8	1/8	1/8	1/8	1/8	1/8	1/8	1/8	1/4	1/4	1/8	1/8	1/8
(O.D. range in inches)	1/2	1/2	3/8	3/4	1	3/4	1	1	3/4	3/4	1/2	2	2
Maximum Working Pressure Depends on tubing material, O.D., wall thickness and connector size.	135	500	500	1200	2000	2000	2000	2000	150	150	250	150	50/220

VIBRATION (COMPARATIVE)

Fair													
Good													
Excellent													

TUBING TYPES

Copper													
Steel													
Aluminum													
Stainless Steel-Annealed													
Stainless Steel-1/8-Hard													
Polyethylene							w/insert	w/insert					
Nylon									w/insert				
Polyvinyl Chloride (PVC)							w/insert	w/insert					
Bundy							B	B					

CONFORMS

SAE													
NSF Listed													
FDA Listed													N
UL				F	F	F	F						
ASA													
ASME													
Military									H				
DOT												H	

TYPICAL USE

Instrumentation													
Oil-Air-Water													
Refrigeration													
Hydraulic Systems													
Cooling Systems													
Lubrication Systems													
Air Brake													

 Recommendation and Applicability

B — May be used if bundy is tin dipped
N — Nylon material

F — Available on special order

H — Available in most sizes

Application Data

Thread Identification

American Connections

NPTF (National Pipe Tapered Fuel)

This connection is still widely used in fluid power systems, even though it is not recommended by the National Fluid Power Association (NFPA) for use in hydraulic applications. The thread is tapered and the seal takes place by deformation of the threads.

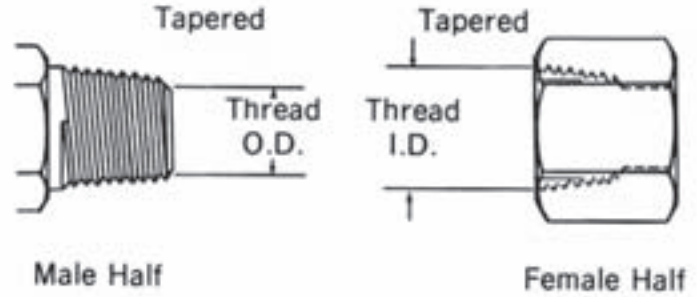

NPTF Threads

Measure thread diameter and subtract 1/4-inch to find the nominal pipe size.

INCH SIZE	DASH SIZE	NOMINAL THREAD SIZE	MALE THREAD O.D. INCH		FEMALE THREAD I.D. INCH	
			fraction	decimal	fraction	decimal
1/8	02	1/8-27	13/32	.41	3/8	.38
1/4	04	1/4-18	17/32	.54	1/2	.49
3/8	06	3/8-18	11/16	.68	5/8	.63
1/2	08	1/2-14	27/32	.84	25/32	.77
3/4	12	3/4-14	1-1/16	1.05	1	.98
1	16	1-11-1/2	1-5/16	1.32	1-1/4	1.24
1-1/4	20	1 1/4-11-1/2	1-21/32	1.66	1-19/32	.58
1-1/2	24	1 1/2-11-1/2	1-29/32	1.90	1-13/16	1.82
2	32	2-11-1/2	2-3/8	2.38	2-5/16	2.30

NPSM (National Pipe Straight Mechanical)

This connection is sometimes used in fluid power systems. The female half has a straight thread and an inverted 30° seat. The male half of the connection has a straight thread and a 30° internal chamfer. The seal takes place by compression of the 30° seat on the chamfer. The threads hold the connection mechanically.

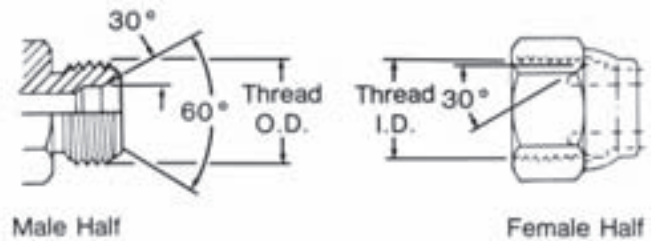

NOTE: A properly chamfered NPTF male will also seal with the NPSM female.

INCH SIZE	DASH SIZE	NOMINAL THREAD SIZE	MALE THREAD O.D. INCH		FEMALE THREAD I.D. INCH	
			fraction	decimal	fraction	decimal
1/8	02	1/8-27	13/32	.41	3/8	.38
1/4	04	1/4-18	17/32	.54	1/2	.49
3/8	06	3/8-18	11/16	.68	5/8	.63
1/2	08	1/2-14	27/32	.84	25/32	.77
3/4	12	3/4-14	11/16	1.05	1	.98
1	16	1-11-1/2	15/16	1.32	1-1/4	1.24
1-1/4	20	1 1/4-11-1/2	1-21/32	1.66	1-19/32	.58
1-1/2	24	1 1/2-11-1/2	1-29/32	1.90	1-13/16	1.82
2	32	2-11-1/2	2-3/8	2.38	2-5/16	2.30

Application Data

Thread Identification

American Connections

SAE J514 37° Hydraulic

This connection is very common in fluid power systems. Both the male and female halves of the connections have 37° seats. The seal takes place by establishing a line contact between the male flare and the female cone seat.

The threads hold the connection mechanically.

CAUTION: In the -02, -03, -04, -05, -08 and -10 sizes, the threads of the SAE 45° flare and the SAE 37° flare are the same. However, the sealing surface angles are not the same.

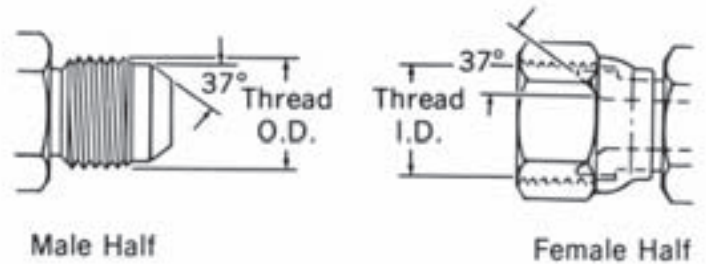

INCH SIZE	DASH SIZE	NOMINAL THREAD SIZE	MALE THREAD O.D. INCH		FEMALE THREAD I.D. INCH	
			fraction	decimal	fraction	decimal
1/8	02	5/16-24	5/16	.31	9/32	.27
3/16	03	3/8-24	3/8	.38	11/32	.34
1/4	04	7/16-20	7/16	.44	13/32	.39
5/16	05	1/2-20	1/2	.50	15/32	.45
3/8	06	9/16-18	9/16	.56	17/32	.51
1/2	08	3/4-16	3/4	.75	3/4	.69
5/8	10	7/8-14	7/8	.88	13/16	.81
3/4	12	1 1/16-12	1-1/16	1.06	1	.98
7/8	14	1 3/16-12	1-3/16	1.19	1-1/8	1.13
1	16	1 5/16-12	1-5/16	1.31	1-1/4	1.23
1-1/4	20	1-5/8-12	1-5/8	1.63	1-9/16	1.54
1-1/2	24	1-7/8-12	1-7/8	1.88	1-13/16	1.79
2	32	2-1/2-12	2-1/2	2.50	2-7/16	2.42

Application Data

Thread Identification

American Connections

SAE J512 Inverted

This connection is frequently used in automotive systems. The male connector can either be a 45° flare in the tube fitting form or a 42° seat in the machined adapter form. The female has a straight thread with a 42° inverted flare. The seal takes place on the flared surfaces. The threads hold the connection mechanically.

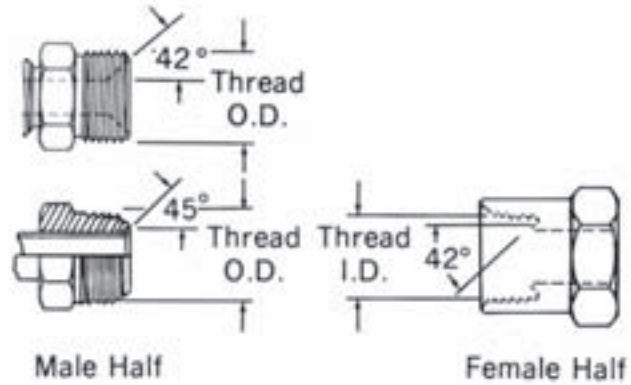

INCH SIZE	DASH SIZE	NOMINAL THREAD SIZE	MALE THREAD O.D. INCH		FEMALE THREAD I.D. INCH	
			fraction	decimal	fraction	decimal
1/8	02	5/16-24	5/16	.32	9/32	.28
3/16	03	3/8-24	3/8	.38	11/32	.34
1/4	04	7/16-24	7/16	.44	13/32	.40
5/16	05	1/2-20	1/2	.50	15/32	.45
3/8	06	5/8-18	5/8	.63	9/16	.57
7/16	07	11/16-18	11/16	.69	5/8	.63
1/2	08	3/4-18	3/4	.75	23/32	.70
5/8	10	7/8-18	7/8	.88	13/16	.82
3/4	12	1 1/16-16	11/16	1.06	1	1.00

Application Data

Thread Identification

American Connections

SAE J512 45°

This connection is commonly used in refrigeration, automotive and truck piping systems. The connector is frequently made of brass. Both the male and female connectors have 45° seats. The seal takes place between the male flare and the female cone seat. The threads hold the connection mechanically.

CAUTION: In the -02, -03, -04, -05, -08 and -10 sizes, the threads of the SAE 45° flare and the SAE 37° flare are the same. However, the sealing surface angles are not the same.

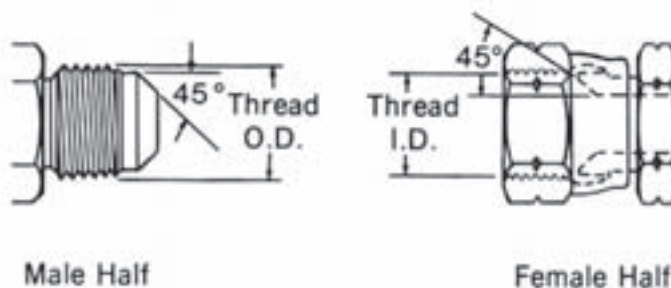

INCH SIZE	DASH SIZE	NOMINAL THREAD SIZE	MALE THREAD O.D. INCH		FEMALE THREAD I.D. INCH	
			fraction	decimal	fraction	decimal
1/8	02	5/16-24	5/16	0.31	9/32	0.27
3/16	03	3/8-24	3/8	0.38	11/32	0.34
1/4	04	7/16-20	7/16	0.44	13/32	0.39
5/16	05	1/2-20	1/2	0.50	15/32	0.45
3/8	06	5/8-18	5/8	0.63	9/16	0.57
1/2	08	3/4-16	3/4	0.75	11/16	0.69
5/8	10	7/8-14	7/8	0.88	13/16	0.81
3/4	12	1-1/16-14	1-1/16	1.06	1	0.99
7/8	14	1-1/4-12	1-1/4	1.25	1-5/32	1.16
1	16	1-3/8-12	1-3/8	1.38	1-9/32	1.29

Application Data

Thread Identification

British Connections

British Standard Pipe (BSP)

This BSPT (tapered) connection is similar to the NPT, except that the thread pitches are different in most sizes, and the thread form and O.D.s are close but not the same. Sealing is accomplished by thread distortion. A thread sealant is recommended.

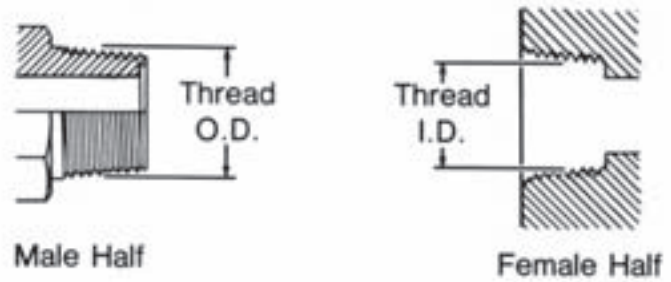

The BSP (parallel) male is similar to the NPSM male except the thread pitches are different in most sizes.

The female swivel BSPP has a tapered nose/Globeseal flareless swivel which seals on the cone seat of the male.

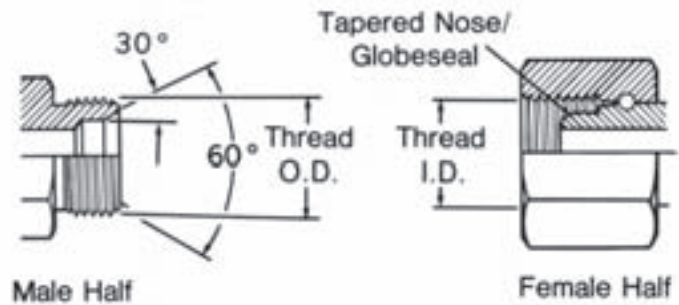

BSPT/BSPP Threads

INCH SIZE	DASH SIZE	NOMINAL THREAD SIZE*	MALE THREAD O.D. INCH		FEMALE THREAD I.D. INCH	
			fraction	decimal	fraction	decimal
1/8	02	1/8-28	3/8	0.38	11/32	0.35
1/4	04	1/4-19	33/64	0.52	15/32	0.47
3/8	06	3/8-19	21/32	0.65	19/32	0.60
1/2	08	1/2-14	13/16	0.82	3/4	0.75
5/8	10	5/8-14	7/8	0.88	13/16	0.80
3/4	12	3/4-14	11/32	1.04	31/32	0.97
1	16	1-11	15/16	1.30	1-7/32	1.22
1-1/4	20	1-1/4-11	1-21/32	1.65	1-9/16	1.56
1-1/2	24	1-1/2-11	1-7/8	1.88	1-25/32	1.79
2	32	2-11	2-11/32	2.35	2-1/4	2.26

*Frequently, the thread size is expressed as a fractional dimension preceded by the letter "G" or the letter "R". The "G" represents a parallel thread and the "R" indicates a tapered thread. For example, BSPP 3/8-19 may be expressed as G 3/8, and BSPT 3/8-19 may be expressed as R3/8.

Selection

To select tubing for a particular installation, two factors must be determined...

Tubing Types

1. Tubing Type:

material and construction

2. Size:

Inside diameter (I.D.) and wall thickness. Information listed below will aid in your tubing selection. Commercial tubing is available in a wide variety of materials, types of construction and quality. Each is best suited for certain specific applications.

Aluminum Tubing

Seamless annealed is approved by SAE for low pressure applications.

Copper Tubing:

Seamless fully annealed coils and fully annealed or quarter-hard straight lengths can be used for systems that do not use petroleum based fluids (copper acts as an oil-oxidation catalyst, causing sludge). Copper also tends to work harden when flared or bent and has poor resistance to vibration. Therefore, the use of copper tubing is limited to low-pressure stationary applications and air circuits.

Special Alloy Tubing:

May be required for specific corrosion problems. Information on these applications can be obtained from your tubing supplier or from tubing manufacturers.

Tubing Size

The two variables in tubing size are the inside diameter (ID) and the wall thickness. Each of these is dependent upon a number of factors.

Inside Diameter –

The tubing I.D. will determine the flow and velocity of the fluid in the system.

Flow is the volume of fluid that is to be moved through the line to perform a given job within a specified time. Flow rate is expressed in gallons per minute (gpm).

Velocity is the rate of speed at which the fluid passes through the line. It is expressed in feet per second (fps). With a given flow rate, the velocity will increase as the inside diameter of the tubing decreases.

Note:

To determine the appropriate tubing I.D. for specific flow rate and velocity, refer to the Velocity vs. Flow chart on page 17.

Wall Thickness

The required wall thickness of the tubing depends upon operating pressure, safety factor, temperatures, and tubing material.

Operating Pressure is the pressure of the fluid in the system. It is expressed in pounds per square inch (psi).

Safety Factor is a multiplier applied to the wall thickness that compensates for additional mechanical strains and hydraulic shocks to which the tubing may be subjected during operation.

Note:

To determine the appropriate wall thickness, refer to the data on page 16 .

Pressure Drop

Total pressure supplied to a line must equal usable pressure (or output) plus the pressure that is lost through fluid transmission, which is referred to as pressure drop. These pressure drops cause loss of energy and should be kept to a minimum. Elements which cause pressure drop in the transmission of fluids include sudden enlargements or contractions, bends, fittings and valves.

Mathematical analysis of pressure drop, although possible, is not precise because of the interrelationship of factors such as fluid velocity, density, flow area and friction coefficients. Therefore, to obtain optimum efficiency, the system (or the questionable portions of the system) should be mocked-up to obtain empirical pressure drop data.

Application Data

Tubing Selection

 Refer to safety information regarding proper selection of tubing and tube connectors on page 1.

Problem

Following is a typical problem that illustrates, step by step, the procedure for determining tube size.

Select Bundyweld tubing with the appropriate I.D. and wall thickness for the following conditions:

Flow — 5 gpm

Velocity — not to exceed 10 fps

Pressure — 2000 psi

Safety Factor — 4:1

Solution

- Using the Flow/Velocity chart on Page 17, follow the horizontal flow line (5 gpm) until it intersects the vertical velocity line (10fps). From this point, follow the diagonal line upward to get the required tube I.D. (.444). If the horizontal flow line and the vertical velocity line intersect between two diagonal lines, normally the larger inside diameter would be selected since it would mean less velocity.
- Refer to the chart of Standard Size Hydraulic Tubing, below. Note that .444 I.D. tubing is not listed. If you want to use standard tubing, select one with a larger I.D. Do not select a smaller size

since this would increase the velocity to over the 10 fps limit. Therefore, by going to the next largest size, you would select the 5/8" O.D. tubing having an I.D. of .459 and a wall thickness of .083.

- To determine whether this tubing will meet the pressure and safety factor requirements, refer to the Recommended Wall Thickness data on page 18. For 5/8" O.D. tubing at 2000 psi, the chart for Bundyweld indicates that the minimum wall thickness with a safety factor of 4:1 is .05952. Since you have selected a tubing with a .083 wall, this would easily fulfill the requirements. However,

for savings on weight and cost, you can select another tubing with a thinner wall that will still meet the performance requirements. Therefore, refer again to the chart on standard size tubing and select a tubing with a wall thickness closer to the minimum requirements. This would be the 5/8" O.D. tubing with a .509 I.D. and a .058 wall. This tubing will handle the pressure requirements of 2000 psi with a safety factor of 4:1, and also provides the required flow while keeping the velocity within the 10 fps limitation.

Standard Size Hydraulic Tubing

TUBE O.D.	TUBE I.D.	TUBE WALL	TUBE O.D.	TUBE I.D.	TUBE WALL	TUBE O.D.	TUBE I.D.	TUBE WALL	TUBE O.D.	TUBE I.D.	TUBE WALL
1/8"	.055	.035	3/8"	.245	.065	5/8"	.435	.095	7/8"	.657	.109
	.061	.032		.259	.058		.459	.083		.685	.095
	.065	.030		.277	.049		.481	.072		.709	.083
	.069	.028		.291	.042		.495	.065		.731	.072
3/16"	.117	.035		.305	.035		.509	.058		.745	.065
	.123	.032		.311	.032		.527	.049		.759	.058
	.127	.030	1/2"	.310	.095		.541	.042		.777	.049
1/4"	.120	.065		.334	.083		.555	.035	1"	.760	.120
	.134	.058	.358	.072	3/4"	.532	.109	.782		.109	
	.152	.049	.370	.065		.560	.095	.810		.095	
	.166	.042	.384	.058	3/4"	.584	.083	.834		.083	
	.180	.035	.402	.049		.606	.072	.856		.072	
.190	.030	.416	.042	.620		.065	.870	.065			
5/16"	.182	.065		.430	.035		.634	.058		.884	.058
	.196	.058		.436	.032		.652	.049		.902	.049
	.214	.049					.680	.035			
	.228	.042									
	.242	.035									
	.248	.032									

Application Data

Tubing Selection

Flow/Velocity Chart

To Find Required Tube I.D.

Flow—20 gpm
Velocity—9 fps

Follow horizontal flow line (20 gpm) until it intersects vertical velocity line (9 fps). From this point follow diagonal line to get required Tube I.D. —(.944).

To Find Permissible Flow

Velocity—15 fps
Tube I.D.—.495

Follow vertical velocity line (15 fps) until it intersects diagonal line representing .495 tube I.D. Then project this point horizontally to get the permissible flow—(9 gpm).

To Find Velocity of Fluid in System

Flow—6 gpm
Tube I.D.—.694

Follow horizontal flow line (6 gpm) until it intersects diagonal line representing .694 tube I.D. Then project this point vertically downward to get the velocity of fluid —(5 fps).

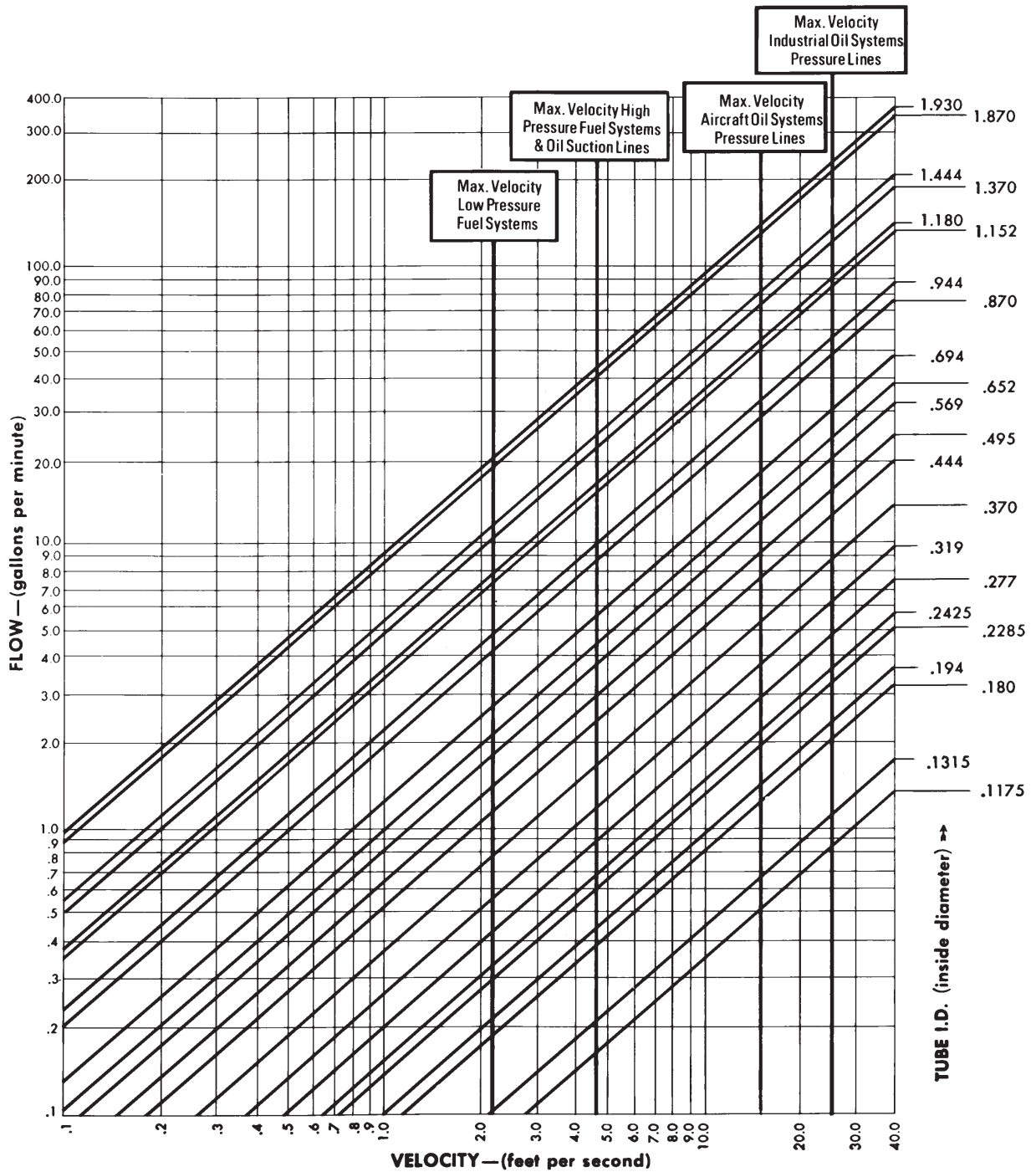

Application Data

Tubing Selection

 Refer to safety information regarding proper selection of tubing and tube connectors on page 1.

With the following Recommended Wall

Thickness tables the tubing wall can be selected that is best suited for a particular application. The data given in these tables are raw figures based on the equation:

$$t = \frac{Dp(FS)}{2S}$$

t – wall thickness (inches)

D – O.D. of tube (inches)

p – pressure (psi)

FS– Safety Factor

S – tensile strength of tubing material

Therefore, many of the wall thicknesses given in these tables are not found on standard tubing, but serve to establish the minimum wall required.

Safety Factor

The standard safety factors indicate three grades of severity of service:

4:1 – mechanical and hydraulic shocks not excessive

6:1 – considerable mechanical strain and hydraulic shock

8:1 – hazardous applications with severe service conditions

The wall thickness shown in these tables are based on ultimate strength of material and a safety factor of 4:1.

To obtain the recommended wall for a specific pressure based on a safety factor of 6:1, multiply the wall thickness indicated in the table by 1.5. For a safety factor of 8:1, multiply by 2

Temperature

The wall thickness found by using these tables can be corrected for temperature by multiplying the wall thickness by the appropriate correction factor given in the chart below. The table is based on strength reduction due to increased temperature.

Recommended Wall Thickness

TEMPERATURE	COPPER	ALUMINUM
+100F.	1.00	1.00
+200F.	1.08	1.00
+300F.	1.22	1.08
+400F.	2.30	1.41
+500F.	–	2.10
+600F.	–	–
+700F.	–	–
+800F.	–	–
+900F.	–	–
+1000F.	–	–

Bundyweld

Based on 42,000#/IN.² Strength (F S=4)

O.D.	WORKING PRESSURE (PSI)				
	1,000	2,000	3,000	4,000	5,000
1/8	.00595	.01190	.01786	.02381	.02976
3/16	.00893	.01786	.02679	.03571	.04464
1/4	.01190	.02381	.03571	.04762	.05952
5/16	.01488	.02976	.04464	.05952	.07440
3/8	.01786	.03571	.05357	.07143	.08929
1/2	.02381	.04762	.07143	.09524	.11905
5/8	.02976	.05952	.08929	.11905	.14881

Aluminum 3003 (H-14) Based on 20,000#/IN.² Strength (F.S. –4)

TUBE O.D.	WORKING PRESSURE (PSI)				
	1,000	2,000	3,000	4,000	5,000
1/8	.01250	.02500	.3750	.05000	
3/16	.01875	.03750	.05650	.07500	
1/4	.02500	.05000	.07500	.10000	
5/16	.03125	.06250	.09375	.12500	
3/8	.03750	.07500	.11250	.15000	
1/2	.05000	.10000	.15000	.20000	
5/8	.06250	.12500	.18750	.25000	
3/4	.07500	.15000	.22500	.30000	
7/8	.08750	.17500	.26250	.35000	
1	.10000	.20000	.30000	.40000	
1-1/4	.12500	.25000	.37500	.50000	
1-1/2	.15000	.30000	.45000	.60000	
2	.20000	.40000	.60000	.80000	

Aluminum 5052 (H-32) Based on 31,000#/IN.² Strength (F.S. –4)

TUBE O.D.	WORKING PRESSURE (PSI)				
	1,000	2,000	3,000	4,000	5,000
1/8	.00806	.01613	.02419	.03226	.04032
3/16	.01210	.02419	.03629	.04839	.06048
1/4	.01613	.03226	.04839	.06452	.08065
5/16	.02016	.04032	.06048	.08065	.10081
3/8	.02419	.04839	.07258	.09677	.12097
1/2	.03227	.06452	.09677	.12903	.16129
5/8	.04032	.08065	.12097	.16129	.20161
3/4	.04839	.09677	.14516	.19355	.24194
7/8	.05645	.11290	.16935	.22581	.28226
1	.06452	.12903	.19355	.25806	.32258
1-1/4	.08065	.16129	.24194	.32258	.40323
1-1/2	.09677	.19355	.29032	.38710	.48387
2	.12903	.25806	.38710	.51613	.64516

Annealed Copper Based on 30,000#/IN.² Strength (F.S. –4)

TUBE O.D.	WORKING PRESSURE (PSI)				
	1,000	2,000	3,000	4,000	5,000
1/8	.00833	.01667	.02500	.03333	.04167
3/16	.01250	.02499	.03750	.04999	.06250
1/4	.01667	.03333	.05000	.06666	.08333
5/16	.02083	.04167	.06250	.08333	.10417
3/8	.02499	.04999	.07500	.09999	.12499
1/2	.03333	.06667	.10000	.13333	.16667
5/8	.04167	.08333	.12500	.16666	.20883
3/4	.04999	.09999	.15000	.19999	.24999
7/8	.05833	.11667	.17500	.23333	.29166
1	.06667	.13333	.20000	.26666	.33333
1-1/4	.08333	.16667	.25000	.33333	.41667
1-1/2	.09999	.19999	.30000	.39999	.49999
2	.13333	.26667	.40000	.53333	.66667

Copper (UNS C12200 Light Drawn) Based on 40,000#/IN.² Strength (F.S. –4)

TUBE O.D.	WORKING PRESSURE (PSI)				
	1,000	2,000	3,000	4,000	5,000
1/8	.00625	.01250	.01875	.02500	.03125
3/16	.00938	.01875	.02812	.03750	.04688
1/4	.01250	.02500	.03750	.05000	.06250
5/16	.01562	.03125	.04688	.06250	.07812
3/8	.01875	.03750	.05625	.07500	.09375
1/2	.02500	.05000	.07500	.10000	.12500
5/8	.03125	.06250	.09375	.12500	.15625
3/4	.03750	.07500	.11250	.15000	.18750
7/8	.04375	.08750	.13125	.17500	.21875
1	.05000	.10000	.15000	.20000	.25000
1-1/4	.06250	.12500	.18750	.25000	.31250
1-1/2	.07500	.15000	.22500	.30000	.37500
2	.10000	.20000	.30000	.40000	.50000

Shaded Areas

Tubing wall thickness listed in the shaded areas are generally either too light or too heavy for practical applications, and are listed only to provide data for accurate computation.

Application Data

Flare Dimensions

JIC 37° FLARE TUBES

(SAE J533)

TUBE SIZE O.D.	SINGLE FLARE A DIAMETER		DOUBLE FLARE B DIAMETER		R RADIUS ±.020	MAXIMUM WALL THICKNESS	
	MAX.	MIN.	MAX.	MIN.		SINGLE FLARE D	DOUBLE FLARE D
1/8	.200	.180	.200	.180	.030	.035	.025
3/16	.280	.260	.280	.260	.030	.035	.028
1/4	.360	.340	.360	.340	.030	.065	.035
5/16	.430	.400	.430	.400	.030	.065	.035
3/8	.490	.460	.490	.460	.040	.065	.049
1/2	.660	.630	.660	.630	.060	.083	.049
5/8	.790	.760	.790	.760	.060	.083	.049
3/4	.950	.920	.960	.920	.080	.109	.049
7/8	1.070	1.040	1.070	1.040	.080	.109	.065
1	1.200	1.170	1.200	1.170	.090	.120	.065
1 1/4	1.510	1.480	1.510	1.480	.090	.120	.065
1 1/2	1.730	1.700	1.730	1.700	.110	.120	.065
2	2.360	2.330	2.360	2.330	.110	.134	.065

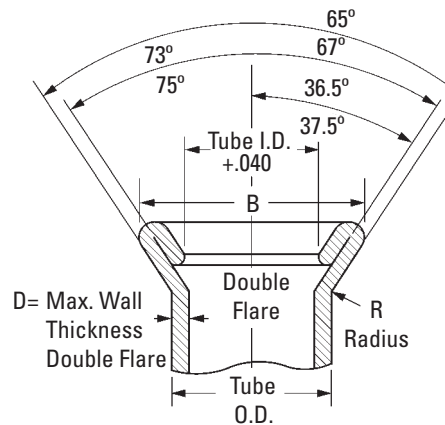
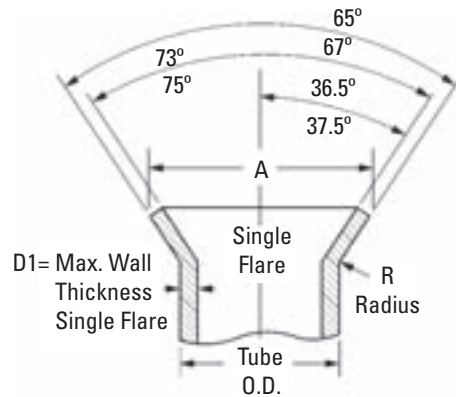

Application Data

Flare Dimensions

SAE 45° FLARE TUBES

(SAE J533)

TUBE SIZE	SINGLE FLARE A DIAMETER		SINGLE FLARE B DIAMETER		DOUBLE COINED FLARE SEAT LENGTH C	MAXIMUM WALL THICKNESS	
	MAX.	MIN	MAX	MIN		SINGLE FLARE D	DOUBLE FLARE D ₁
1/8	.171	.181	.198/	.213	.040	.035	.025
3/16	.239/	.249	.265/	.280	.040	.035	.028
1/4	.315/	.325	.345/	.360	.040	.049	.035
5/16	.388/	.404	.410/	.425	.062	.049	.035
3/8	.471/	.487	.485/	.500	.062	.065	.049
7/16	.545/	.561	.555/	.570	.062	.065	.049
1/2	.607/	.623	.625/	.640	.062	.083	.049
9/16	.660/	.676	.697/	.712	.062	.083	.049
5/8	.732/	.748	.757/	.772	.062	.095	.049
3/4	.900/	.916	.897/	.912	.062	.109	.049
7/8	1.025/	1.041	—	—	—	.109	—
1	1.141/	1.157	—	—	—	.120	—

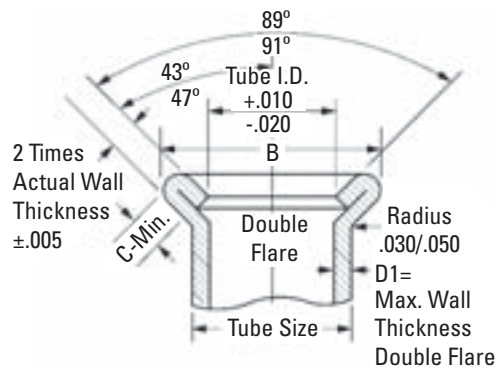
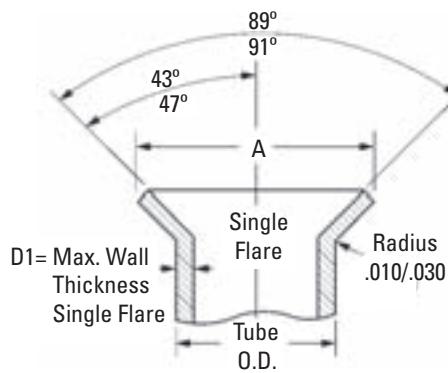

Application Data

Tubing Installation

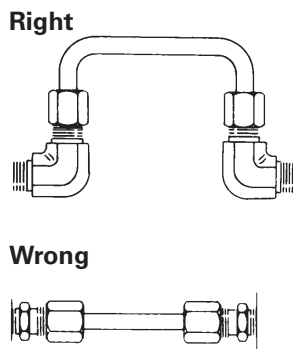

Figure 1

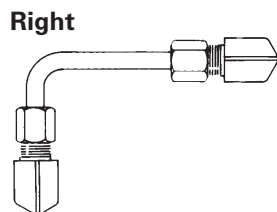

Figure 2

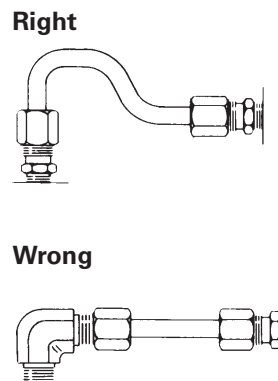

Figure 3

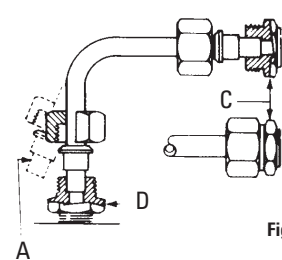

Figure 4

Note:

Springing the tubing to force alignment places strain on fitting joints.

Nearly all industrial equipment now in service makes some use of fluid lines. From an economic point of view, the best fluid lines system is that which is easiest to maintain at the lowest original cost. The use of tubing and tube connectors on lines up to 2" diameter is usually more economical than the use of pipe and pipe connectors in modern installations. A few of the more important reasons follow:

1. Size for size, tubing is lighter weight, easier to handle and can be bent more easily than iron pipe.
2. Ductile hydraulic tubing reduces the number of connections required, thus reducing material and labor costs. Bent tubing also reduces pressure drop and turbulence in the system.
3. Fewer joints means lower costs and fewer points of potential leakage.
4. The use of tube connectors makes every joint a union, permitting easier, faster maintenance and repair work.
5. Modern flared and flareless tube fittings eliminate the need for threading, soldering, or welding.

Tube Bending

Tubing should be bent wherever possible to reduce the number of connectors.

Copper tubing can be bent easily with a hand bender. Steel tubing can be bent in sizes 1/8" to 5/8" O.D. by using a hand bender designed for steel tubing. For production quantities, or for sizes larger than 5/8" O.D., a power bender is generally used.

Tubing should be bent accurately. Tubing manufacturers will advise the correct radii for various types and wall thicknesses of tubing. Kinks, flattened bends, wrinkles and tube breakage or loss should be avoided by the use of proper tube bending equipment.

Precautions

Avoid straight line connections wherever possible, especially in short runs.

Design piping systems symmetrically. They are easier to install and present a neat appearance.

Care should be taken to eliminate stress from tubing lines. Long tubing runs should be supported by brackets or clips. All parts installed on tubing lines such as heavy fittings, valves, etc., should be bolted down to eliminate tubing fatigue.

Before installing tubing, inspect the tube to see that it conforms to the required specifications, is of the correct diameter and wall thickness and is not out of round.

Cut tube ends reasonably square and lightly deburr inside and outside edge. Chamfer on outside edge will destroy bearing of tube end on the connector seat.

To avoid difficulty in assembly and disconnecting, a sufficient straight length of tube must be allowed from the end of the tube to the start of the bend. Allow twice the length of the nut as a minimum.

Tubes should be formed to assemble with true alignment to the center line of the fittings, without distortion or tension. Tubing which has to be sprung from position, "A", (see Fig. 4), to be inserted into the connector has not been properly fabricated, and when so installed and connected, places the tubing under stress.

When assembling the tubing, insert the longer leg to the connector as at "C" (Fig. 4). With the nut free, the short leg of the tubing can be easily moved and brought to proper position with and inserted into the seat in connector "D". The nuts can then be tightened as required.

Application Data

Chemical Compatibility Chart

 Refer to safety information regarding proper selection of tubing and tube connectors on page 1.

These tables alphabetically list commonly used materials of various chemical composition. After each agent listing you will find the basic tubing and connector materials rated according to their chemical resistance to each individual agent. The chart is intended to be used as a guide only. Many factors (concentration, temperature, intermittent or continuous exposure, etc.) have a

bearing upon the suitability of any tubing or connector for any specific application, and these factors must be considered by you as you review the chemical compatibility chart.

Where unusual conditions exist or where questions arise, consult Eaton for expert assistance on your tubing application requirements.

Note:

All data given herein is believed to be accurate and reliable but presented without guarantee, warranty, or responsibility of any kind, express or implied, on our part. Chemical resistance will vary with the wide diversity of possible mixtures and service conditions. It is not therefore possible to give any guarantee whatsoever in individual cases.

FLUID	NYLON 11 TP160 NT100	NYLON 6/6 PT230	PVC PT200	POLYETHYLENE PT240 (LDPE)	BRASS
Acetaldehyde	G	F	X	X	G
Acetic Acid (Concentrated)	X	X	X	X	X
Acetic Acid (Dilute)	F	X	F	G	X
Acetic Anhydride	X	X	X	X	X
Acetone	G	F	X	G	G
Acrylonitrile	G	—	G	—	—
Air	G	G	G	G	G
Alcohols					
Amyl Alcohol	G	G	X	G	G
Butyl Alcohol, Butanol	G	G	X	G	G
Ethyl Alcohol, Ethanol	G	G	F	G	G
Isopropyl Alcohol, Isopropanol	G	G	G	G	G
Methyl Alcohol, Methanol	G	G	X	G	G
Aluminum Chloride	X	X	G	G	X
Aluminum Fluoride	X	X	G	G	X
Aluminum Hydroxide	G	G	G	G	X
Aluminum Nitrate	G	F	G	G	X
Aluminum Sulfate	G	F	G	G	X
Alums	F	G	G	G	X
Ammonia, Anhydrous	Use approved anhydrous ammonia hose				X
Ammonia Solution (10%)	G	X	G	G	X
Ammonium Chloride	X	X	G	G	X
Ammonium Hydroxide	G	X	X	G	X
Ammonium Nitrate	G	G	G	G	X
Ammonium Phosphate	G	G	F	G	X
Ammonium Sulfate	G	G	G	G	X
Amyl Acetate	G	G	X	X	G
Amyl Alcohol	G	G	X	G	G
Aniline	X	X	X	X	X
Aniline Dyes	X	X	X	X	X
Animal Oils and Fats	G	—	G	X	G
Anti-Freeze (Glycol Base)	G	—	G	F	G
Aqua Regia	X	X	X	X	—
Aromatic Hydrocarbons	G	G	X	G	G
Asphalt Emulsion	G	—	X	—	G
Barium Chloride	G	—	G	G	G
Barium Hydroxide	G	G	G	G	X
Barium Sulfate	G	G	G	G	G
Barium Sulfide	X	—	G	G	X
Beet Sugar Liquors	G	G	G	G	X
Benzaldehyde	G	G	X	X	F
Benzene, Benzol	G	G	X	X	G
Benzoic Acid	X	X	X	G	G
Black Sulfate Liquor	X	X	X	G	X
Bleach Solution	X	X	F	G	X

Codes:

- G = Good Resistance
- F = Fair Resistance
- X = Incompatible
- = No data available
- + = Call Technical Support for specific application

Application Data

Chemical Compatibility Chart

 Refer to safety information regarding proper selection of tubing and tube connectors on page 1.

FLUID	NYLON 11 TP160 NT100	NYLON 6/6 PT230	PVC PT200	POLYETHYLENE PT240 (LDPE)	BRASS
Borax Solution	G	—	G	G	G
Boric Acid	G	G	G	G	G
Brake Fluid (Glycol Ether Base)	G	—	X	X	G
Brine	G	—	G	G	G
Bromine	X	X	X	X	X
Butane	Use Butane approved hose				
Butyl Acetate	G	—	X	X	G
Butyl Alcohol, Butanol	G	G	X	G	G
Calcium Bisulfite	G	X	G	G	X
Calcium Chloride	G	X	G	G	X
Calcium Hydroxide	G	G	G	G	G
Calcium Hypochlorite	X	X	G	G	G
Cane Sugar Liquors	G	--	G	G	G
Carbon Dioxide (Dry)	G	G	G	G	G
Carbon Dioxide (Wet)	G	G	G	G	F
Carbon Disulfide (Bisulfide)	X	X	X	X	G
Carbon Monoxide (Hot)	X	X	X	X	G
Carbon Tetrachloride	G	G	X	X	G
Carbonic Acid	G	—	G	G	X
Castor Oil	G	—	G	X	G
Cellosolve Acetate	G	—	X	—	X
Chlorinated Solvents	F	G	X	X	G
Chloroacetic Acid	X	X	X	X	X
Chlorobenzene	X	X	X	X	F
Chlorine Gas (Dry)	X	X	X	X	G
Chlorine Gas (Wet)	X	X	X	X	X
Chloroform	F	G	X	X	G
Chlorosulfonic Acid	X	X	X	X	X
Chromic Acid (under 25%)	X	X	F	F	X
Chromic Acid (over 25%)	X	X	X	X	X
Citric Acid	X	F	G	G	X
Coke Oven Gas	G	—	X	G	F
Copper Chloride	X	X	G	G	X
Copper Cyanide	G	G	G	G	X
Copper Sulfate	G	G	G	G	X
Corn Syrup (Non-food)	G	—	G	G	—
Cottonseed Oil	G	—	F	G	G
Creosote	X	X	X	X	F
Cresol	X	X	X	X	—
Cyclohexanol	G	G	X	F	G
Dextrose (Food Grade)	X	X	X	G	—
Dichlorobenzene	G	—	X	X	—
Diesel Fuel	G	—	X	X	G
Diethanolamine	G	—	X	—	X
Diethylenetriamine	X	X	X	G	—
Dowtherm A	X	X	X	X	X
Enamel (Solvent Base)	G	—	X	G	G
Ethanolamine	G	—	X	G	X
Ethers (Ethyl Ether)	G	—	X	X	G
Ethyl Alcohol	G	G	F	G	G
Ethyl Acetate	G	G	X	G	G
Ethyl Acrylate	X	—	X	—	—
Ethyl Methacrylate	X	—	X	—	—
Ethylamine	X	X	X	G	G
Ethyl Cellulose	F	—	X	G	G
Ethyl Chloride	G	—	X	X	G
Ethylenediamine	X	X	X	G	G
Ethylene Dibromide	F	—	X	—	—
Ethylene Dichloride	F	—	X	X	F

Codes:

G = Good Resistance
 F = Fair Resistance
 X = Incompatible
 -- = No data available
 + = Call Technical Support
 for specific application

Application Data

Chemical Compatibility Chart

 Refer to safety information regarding proper selection of tubing and tube connectors on page 1.

FLUID	NYLON 11 TP160 NT100	NYLON 6/6 PT230	PVC PT200	POLYETHYLENE PT240 (LDPE)	BRASS
Ethylene Glycol	G	G	G	G	G
Ethylene Oxide	G	—	X	X	X
Fatty Acids	G	G	G	G	F
Ferric Chloride 5%	G	G	G	G	X
Ferric Sulfate	G	G	G	G	X
Fertilizer Salts Solution	F	—	G	G	—
Formaldehyde	G	G	X	G	G
Formic Acid	X	X	X	G	F
Freon 12	Use approved Freon 12 hose				G
Freon 134a	Use approved Freon 134a hose				—
Fuel Oil	G	—	F	X	G
Furfural	X	X	X	X	G
Gasoline (Refined)	G	G	X	X	G
Gasoline (Unleaded)	G	G	X	X	G
Gasoline (10% Ethanol)	G	G	X	X	G
Gasoline (10% Methanol)	G	G	X	X	G
Glucose (non-food)	G	G	G	G	G
Glycerine, Glycerol (Non-food)	G	G	G	G	G
Greases	G	G	G	G	G
Green Sulfate Liquor	X	X	G	G	X
Heptane	G	G	X	X	G
Hexane	G	G	X	X	G
Houghto Safe 273 to 640	G	—	F	G	G
Houghto Safe 5046, 5047F	G	—	G	G	G
Houghto Safe 1000 Series	G	—	X	X	G
Hydraulic Oils					
Straight Petroleum Base	G	G	G	G	G
Water Petroleum Emulsion	G	—	—	F	G
Water Glycol	G	G	X	—	G
Straight Phosphate Ester	G	G	X	X	G
Phos. Ester/Petroleum Blend	G	G	X	X	G
Polyol Ester	G	—	—	—	G
Hydrobromic Acid (under 48%)	X	X	G	G	X
Hydrochloric Acid	X	X	G	G	X
Hydrocyanic Acid	X	X	G	G	G
Hydrofluoric Acid (under 50%)	X	X	F	F	X
Hydrofluoric Acid (over 50%)	X	X	X	X	X
Hydrofluosilicic Acid	X	X	G	G	X
Hydrogen	Use approved hydrogen hose or metal tubing				G
Hydrogen Peroxide	X	X	—	G	X
Hydrogen Sulfide	X	X	G	G	G
Hydrolube	G	—	G	G	G
Iodine	X	X	X	X	X
Isocyanates	X	X	X	X	—
Isopropyl Alcohol, Isopropanol	G	G	G	G	G
Isopropylamine	X	—	X	—	G
Iso-Octane	G	G	X	X	G
Jet Fuel (Transfer Only)	G	G	X	X	G
Kerosene	G	G	X	X	G
Lacquer	G	G	X	F	G
Lacquer Solvents	G	G	X	F	G
Lactic Acid	G	G	G	G	F
Lime Sulfur	G	F	G	G	X
Lindol	G	G	—	—	F
Linseed Oil	G	G	G	G	G
Lubricating Oils	G	G	G	G	G
Lye	G	F	G	G	F
Magnesium Chloride	G	G	G	G	F
Magnesium Hydroxide	G	G	G	G	G

Codes:

- G = Good Resistance
- F = Fair Resistance
- X = Incompatible
- = No data available
- + = Call Technical Support for specific application

Application Data

Chemical Compatibility Chart

 Refer to safety information regarding proper selection of tubing and tube connectors on page 1.

FLUID	NYLON 11 TP160 NT100	NYLON 6/6 PT230	PVC PT200	POLYETHYLENE PT240 (LDPE)	BRASS
Magnesium Sulfate	G	G	G	G	G
Mercuric Chloride	X	X	F	G	X
Mercury	G	G	F	G	X
Methyl Alcohol, Methanol	G	G	X	G	G
Methyl Acrylate	X	X	X	—	G
Methyl Bromide	G	F	X	X	G
Methyl Chloride	G	G	X	X	G
Methylene Chloride	F	F	X	X	G
Methyl t-Butyl Ether (MTBE)	G	G	X	—	—
Methyl Ethyl Ketone	G	G	X	G	G
Methyl Isobutyl Ketone	G	G	X	G	G
Methyl Isopropyl Ketone	G	G	X	G	G
Methyl Methacrylate	X	—	X	—	—
Mineral Oil	G	G	F	X	G
Mineral Spirits	G	G	X	G	G
Naphtha	G	G	X	G	—
Naphthalene	G	G	X	X	G
Nickel Acetate	G	G	G	G	F
Nickel Chloride	G	G	G	G	X
Nickel Sulfate	G	G	G	G	G
Nitric Acid (under 35%)	X	X	G	F	X
Nitric Acid (35% to 60%)	X	X	F	X	X
Nitric Acid (over 60%)	X	X	X	X	X
Nitrobenzene	X	—	X	X	G
Nitrogen Gas	G	G	G	G	G
Nitrous Oxide	F	F	X	X	G
Oleic Acid	G	G	F	G	G
Oleum (Fuming Sulfuric Acid)	X	X	X	X	X
Oxalic Acid	X	X	G	G	F
Oxygen (non-breathing, non-welding) +	G	G	G	G	G
Ozone (300 ppm)	X	X	X	X	—
Paint (Solvent Base)	G	G	X	F	G
Palmitic Acid	G	G	F	G	X
Paper Mill Liquors	X	X	X	X	—
Pentane	G	—	X	X	G
Perchloroethylene	F	G	X	X	G
Petroleum Ether	G	G	X	X	G
Petroleum Oils	G	G	G	G	G
Phenol	X	X	X	X	G
Phosphoric Acid (to 85%)	X	X	G	G	G
Picric Acid (Molten)	X	X	X	X	X
Picric Acid (Solution)	X	X	X	X	X
Potassium Chloride	G	G	G	G	F
Potassium Cyanide	G	G	G	G	X
Potassium Dichromate	F	—	G	G	F
Potassium Hydroxide	G	F	G	G	F
Potassium Permanganate	X	X	G	G	—
Potassium Sulfate	G	G	G	G	F
Propane Liquid	Use hose approved for Propane Liquid				G
Propylene Glycol	G	—	F	G	F
Pyridine	X	X	X	G	F
Sea Water	G	G	G	G	G
Silver Nitrate	G	G	G	G	X
Skydrol	G	G	X	X	G
Soap Solution	G	G	G	X	G
Sodium Bicarbonate	G	G	G	G	G
Sodium Bisulfate	G	G	G	G	F
Sodium Bisulfite	G	G	G	G	F

Codes:

G = Good Resistance
 F = Fair Resistance
 X = Incompatible
 — = No data available
 + = Call Technical Support
 for specific application

Application Data

Chemical Compatibility Chart

 Refer to safety information regarding proper selection of tubing and tube connectors on page 1.

FLUID	NYLON 11 TP160 NT100	NYLON 6/6 PT230	PVC PT200	POLYETHYLENE PT240 (LDPE)	BRASS
Sodium Borate	G	G	G	G	G
Sodium Carbonate	G	G	G	G	G
Sodium Chloride	G	G	G	G	X
Sodium Cyanide	G	G	G	G	X
Sodium Hydroxide	G	F	G	G	F
Sodium Hypochlorite	X	X	G	G	X
Sodium Nitrate	G	G	G	G	F
Sodium Perborate	G	F	G	G	X
Sodium Peroxide	X	X	X	X	X
Sodium Phosphates	G	G	G	G	G
Sodium Silicate	G	G	G	G	G
Sodium Sulfate	G	G	G	G	G
Sodium Sulfide	G	G	G	G	X
Sodium Thiosulfate	G	G	G	G	X
Soybean Oil	G	—	F	G	G
Stannic Chloride	F	X	G	G	X
Steam 450° F	X	X	X	X	F
Stearic Acid	G	G	F	G	X
Stoddard Solvent	G	G	X	X	G
Styrene	G	G	X	X	G
Sulfur 70° F	G	G	F	G	X
Sulfur 200° F	X	X	X	X	X
Sulfur Chloride	X	X	X	G	X
Sulfur Dioxide	X	X	X	X	G
Sulfuric Acid (under 50%)	X	X	G	G	X
Sulfuric Acid (51% to 70%)	X	X	G	X	X
Sulfuric Acid (71% to 95%)	X	X	X	X	X
Sulfuric Acid (96% to 98%)	X	X	X	X	X
Tannic Acid	X	X	G	G	G
Tar	G	G	X	X	G
Tartaric Acid	G	G	G	G	F
Tetrachloroethane	F	—	X	F	—
Tetrahydrofuran (THF)	G	—	X	X	—
Toluene	G	G	X	G	G
Transmission Oil (Petrol. Base)	G	G	G	G	G
Trichloroethane	F	G	X	G	G
Trichloroethylene	F	G	X	G	G
Tung Oil	G	—	—	—	G
Turpentine	G	G	X	G	G
Urea (Water Solution)	G	G	G	G	—
Uric Acid	G	G	G	G	—
Varnish	G	G	X	G	G
Vegetable Oil (Non-food)	G	G	F	G	G
Vinegar	G	X	G	G	X
Vinyl Acetate	G	—	X	—	F
Water (non-potable)	G	G	G	G	G
Water-Glycol Mixture	G	G	X	—	G
Water-Petroleum Mixture	G	G	—	F	G
Xylene	G	G	X	G	G
Zinc Chloride	X	X	G	G	X
Zinc Sulfate	G	G	G	G	X

Codes:

- G = Good Resistance
- F = Fair Resistance
- X = Incompatible
- = No data available
- + = Call Technical Support for specific application

Tubing

Plastic Tubing

Note:
For plastic tube cutter,
see page 138.

Part Number Key:

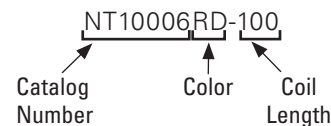

NT100 "Nylon 11"

SAE J844 Type A & B DOT
FMVSS 571.106



Typical Application:

Air brake systems except where temperatures exceed +200°F or where battery acid can drip on tubing.

Construction

Core, Nylon; Braid, Polyamide fiber, (3/8" and larger sizes only); Jacket, Nylon.

Temperature Range:

-40°F to +200°F
(-40°C to +93°C)

Contains: Ultra-Violet Stabilizer in all colors.

Available Colors:

Black (BK), red (RD), blue (BU), brown (BR), silver (SL), green (GN), yellow (YW), orange (OR) and white (WH). Refer to current price list for availability of colors.

Note:

1/8", 5/32", 3/16", 1/4" and 5/16", are SAE J844 Type A (not reinforced);
3/8", 1/2", 5/8" and 3/4" are SAE J844 Type B (reinforced).

Note:

Not all colors available in all sizes. Refer to price pages for availability.

Connectors:

1800 Series
Q-CAB pgs. 76-83

1400 Series
Air Brake pgs. 84-89

For 1/8" Tubing use SelfAlign pgs. 47-52

SelfAlign connectors are not designed to meet DOT standards.

CATALOG NUMBER	TUBE O.D. (IN)	TUBE WALL (IN)	MAX. WORK. PRES. PSI 75°	MIN. BURST PRES. PSI 75°	MIN. BEND RADIUS 70° F	LBS. PER 100 FT.	COIL LENGTH(S) (FT)
NT10002*	1/8 (.125)	.023	150	1,000	.33"	.4	100,500,1000
NT10025*	5/32 (.156)	.032	150	1,000	.41"	.4	100,1000
NT10003	3/16 (.187)	.035	150	1,000	.71"	.6	1000
NT10004	1/4 (.250)	.040	150	1,200	1.19"	1.2	100,500,1000
NT10005	5/16 (.312)	.040	150	1,000	1.25"	1.8	100,500,1000
NT10006	3/8 (.375)	.050	150	1,000	1.5"	2.9	100,500,1000
NT10008	1/2 (.500)	.040	150	1,000	2.0"	3.8	100,500,1000
NT10010	5/8 (.625)	.092	150	900	2.5"	6.8	100,250
NT10012	3/4 (.750)	.092	150	800	3.0"	8.4	100,250

*Insert not required. Does not meet DOT standards.

PT200 Polyvinyl Chloride



Typical Application:

Soft, pliable, plasticized PVC Resin Tubing, for practically any low pressure laboratory, industrial, agricultural or domestic application.

Temperature Range:

-5°F to +105°F
(-20°C to +41°C)

Available Colors:

Clear (suffix NA)

Connectors:

Polyline pgs. 53-56

SelfAlign pgs. 47-52 with 2030x insert

Compression pgs. 41-46 with 2030x insert

Molded Compression pgs. 126-134

CATALOG NUMBER	TUBE O.D. (IN)	TUBE WALL (IN)	MAX. WORK. PRES. PSI 75°	MIN. BURST PRES. PSI 75°	MIN. BEND RADIUS 70° F	LBS. PER 100 FT.	COIL LENGTH(S) (FT)
PT20004	1/4 (.250)	.062	65	195	1.0"	2.0	100
PT20044	1/4 (.250)	.040	55	165	1.0"	2.0	100
PT20005	5/16 (.312)	.062	55	165	1.25"	2.6	100
PT20006	3/8 (.375)	.062	55	165	1.5"	3.3	100
PT20008	1/2 (.500)	.062	45	135	2.0"	4.6	100
PT20010	5/8 (.625)	.062	30	90	2.5"	5.9	100
PT20012	3/4 (.750)	.094	40	120	3.0"	10.3	100
PT20016	1(1.00)	.125	35	105	4.0"	18.5	100

Tubing

Plastic Tubing

Note:
For plastic tube cutter,
see page 138.

Part Number Key:

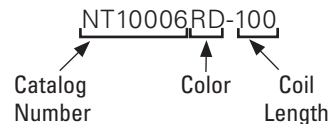

PT230 Polyamide "Nylon 6/6"



Natural off-white compound covered under 21CFR177.1500 regulations for food contact.

Typical Application: Semi-rigid general purpose tubing.

Temperature Range:
-40°F to +180°F
(-40°C to +82°C)

Available Colors:
Natural off-white (NA) and black (BK). FDA colors available on request.

Contains:
Ultra-Violet Stabilizer in black tubing.

Connectors:

SelfAlign pgs. 47-52
Compression pgs. 41-46
Push>Connect pgs. 57-67
Push>Connect Flow Controls pgs. 58, 68-69
Push>Connect Plus pgs. 69-71

CATALOG NUMBER	TUBE O.D. (IN)	TUBE WALL (IN)	MAX. WORK. PRES. PSI 70°	MIN. BURST PRES. PSI 70°	MIN. BEND RADIUS 70° F	LBS. PER 100 FT.	COIL LENGTH(S) (FT)
PT23002	1/8 (.125)	.015	300	1,000	.75"	.3	100, 1,000
PT23003	3/16 (.188)	.023	300	1,000	1.25"	.6	100, 1,000
PT23004	1/4 (.250)	.030	300	1,000	1.5"	1.0	100, 1,000
PT23005	5/16 (.312)	.036	300	1,000	2.0"	1.5-1.6	100, 1,000
PT23006	3/8 (.375)	.040	300	1,000	2.25"	2.1	100, 1,000

PT240 Polyethylene



Meets FDA for food contact. Natural off-white compound covered under 21CFR177.1520 regulations for food contact.

Typical Application:
Economical, flexible, low density Polyethylene has a wide range of uses in industrial and agricultural applications.

Temperature Range:
-40°F to +135°F
(-40°C to +57°C)

Available Colors:
Natural off-white (NA), black (BK), yellow (YW), orange (OR), blue (BU), red (RD), green (GN). FDA colors available on request. Refer to current price list for availability of colors.

Contains:
Ultra-Violet Stabilizer in black tubing.

Connectors:

Minibarb® pgs. 72-75
Polyline pgs. 53-56
Selfalign pgs. 47-52 with 2030 insert
Compression pgs. 41-46 with 2030 insert
Push>Connect pgs. 57-67
Push>Connect Flow Controls pgs. 58, 68-69
Push>Connect Plus pgs. 69-71
Molded Compression pgs. 126-134

CATALOG NUMBER	TUBE O.D. (IN)	TUBE WALL (IN)	MAX. WORK. PRES. PSI 70°	MIN. BURST PRES. PSI 70°	MIN. BEND RADIUS 70° F	LBS. PER 100 FT.	COIL LENGTH(S) (FT)
PT24004	1/4 (.250)	.062	200	600	.75"	1.5	100, 1,000
PT24044	1/4 (.250)	.040	133	400	.62"	1.0	100, 1,000
PT24005	5/16 (.312)	.062	135	480	1.0"	1.9	100, 1,000
PT24006	3/8 (.375)	.062	135	400	1.5"	2.4	100, 1,000
PT24008	1/2 (.500)	.062	100	300	2.0"	3.4	100, 500
PT24010	5/8 (.625)	.062	80	240	2.5"	4.4	100
PT24012	3/4 (.750)	.094	70	210	3.0"	7.6	100
PT24016	1 (1.000)	.125	100	300	5.0"	13.4	100

Tubing

Plastic Tubing

Note:
For plastic tube cutter,
see page 138.

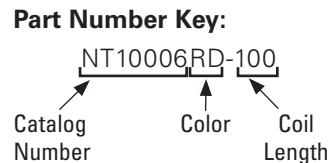

TP160 Polyamide "Nylon 11"



Typical Application:

Flexible nylon tubing. Used for instrumentation; lubrication and air lines; gas, chemical and oil processing; low pressure hydraulics.

Temperature Range:

-40°F to +200°F
(-40°C to +93°C)

Available Colors:

Black (BK) or natural (NA).

Contains:

Ultra-Violet Stabilizer

Connectors:

SelfAlign pgs. 47-52

Compression pgs. 41-46

Connectors (cont.):

Push>Connect pgs. 57-67

Push>Connect Flow Controls pgs. 58, 68-69

Push>Connect Plus pgs. 69-71

Molded Compression pgs. 126-134

CATALOG NUMBER	TUBE O.D. (IN)	TUBE WALL (IN)	MAX. WORK. PRES. PSI 70°	MIN. BURST PRES. PSI 70°	MIN. BEND RADIUS 70° F	LBS. PER 100 FT.	COIL LENGTH(S) (FT)
TP16002	1/8 (.125)	.023	250	1,000	.62"	.30	100, 1,000
TP16025	5/32 (.156)	.029	250	1,000	1"	.75	100, 1,000
TP16004	1/4 (.250)	.040	250	1,000	1.25"	1.2	100, 1,000
TP16005	5/16 (.312)	.040	250	1,000	2"	2.0	100, 1,000
TP16006	3/8 (.375)	.062	250	1,000	3"	2.7	100, 1,000
TP16008	1/2 (.500)	.062	250	1,000	4.5"	3.8	100, 500

MTP160 Polyamide "Nylon 11" Metric Tubing



Typical Application:

Flexible nylon tubing. Used for instrumentation; lubrication and air lines; gas, chemical and oil processing; low pressure hydraulics.

Temperature Range:

-40°F to +200°F
(-40°C to +93°C)

Available Colors:

Natural (NA).

Contains:

Ultra-Violet Stabilizer

Connector:

Metric Push>Connect pgs. 57-67

CATALOG NUMBER	TUBE O.D. (MM)	TUBE WALL (MM)	MAX. WORK. PRES. PSI 75°	MIN. BURST PRES. PSI 75°	MIN. BEND RADIUS 75° F	LBS. PER 100 FT.	COIL LENGTH(S) (FT)
MTP16004	4	.65	250	1,000	.75"	0.6	100
MTP16005	5	1	250	1,000	1"	0.9	100
MTP16006	6	1	250	1,000	1.5"	1.1	100
MTP16008	8	1	250	1,000	2.25"	1.5	100
MTP16010	10	1	200	800	3"	1.9	100
MTP16012	12	1	112	450	3.5"	2.3	100

Brass Products

Introduction

Eaton brass tube fittings are made from high quality UNS CA-360 brass bar. Eaton brass connectors are precision machined to meet SAE standards and specifications. Large, uniform wrench pad areas have standard dimensions for easy assembly and disassembly using standard open-end wrenches. On fittings where pipe threads are used, the fittings are standardized on Dryseal American National Standard Taper. Eaton offers the only complete line of brass connectors with these outstanding advantages.

Shapes

The dies through which the billets are forced may be one of hundreds of shapes. Four of the most common shapes, used in the manufacture of Eaton connectors, are illustrated.

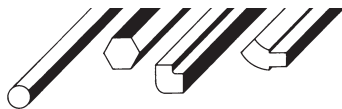

Hot Extrusion

A cast billet is heated and extruded through a die containing the desired configuration. This process recrystallizes the weaker cast structure into the stronger pressed structure of the shaped extrusion.

Hot Extrusion

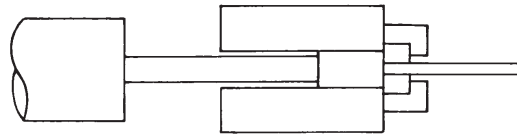

Cold Draw



Cold Draw

The hot extruded shape is pulled through a die with the same configuration but less cross sectional area. This further recrystallizes and refines the structure while increasing the strength and elongation. In addition, the dimensions are brought to close tolerances.

Saw and Machine

The cold bar stock is then cut into individual pieces for precision machining. After the part is machined, it is ready for the market as a strong, tough, high quality connector. Only by using this process is it possible to get the big all-flat sides on elbows and tees, instead of the usual small wrench pads, or lack of flats all together.

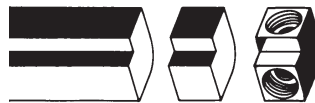

Microstructure

The photomicrographs illustrate the change in microstructure from the low strength low ductility dendritic structure of the cast billet, to the recrystallized structure of the hot extrusion, to the refined structure of the high strength high ductility cold drawn rod.



As Cast - 50x



Hot Extruded
- 200x



Cold Drawn
- 200x

Brass Products

Inverted Flare

Note: For additional technical questions, contact Technical Support at 1-888-258-0222.

 Refer to safety information regarding proper selection of tubing and tube connectors on page 1.

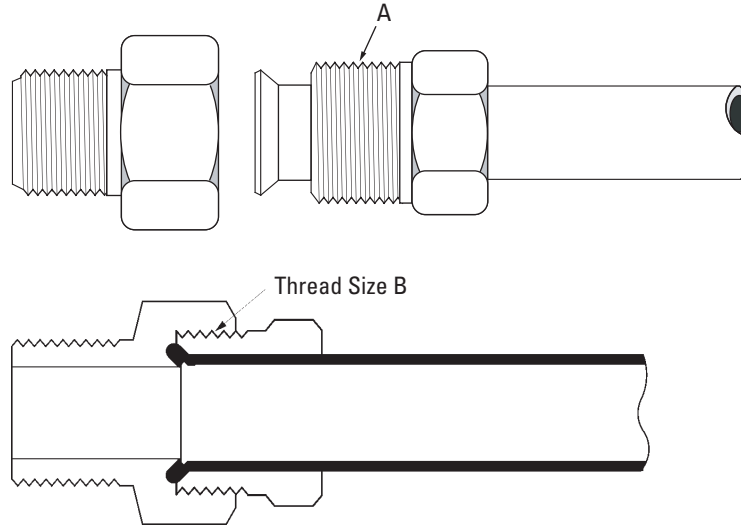

Tube O.D.	1/8	3/16	1/4	5/16	3/8	7/16	1/2	5/8	3/4	7/8	1
Thread Size-B	5/16-28	3/8-24	7/16-24	1/2-20	5/8-18	11/16-18	3/4-18	7/8-18	1-1/16-16	1-3/16-16	1-5/16-16

Typical Application:

Hydraulic brake, power steering, fuel lines and transmission cooler lines, LP and natural gas (special order).

Pressure:

Working pressure up to 2000 psi depending on tube size. Will withstand burst pressure of standard tubing - up to 5000 psi with Bundy-weld (double flared) and 3500 psi with copper tubing, depending on size.

Vibration:

Excellent resistance.

Temperature Range:

-65°F to +250°F (-53°C to +121°C) range at maximum operating pressures.

Material:

CA360 Brass.

Used With:

Copper, brass, aluminum and steel hydraulic tubing that can be flared. See pages 22-26 for material compatibility.

Advantages:

Very low cost and reusable. Seats and threads are internal and protected. Compact, excellent vibration life. Short nut affords very close tube bends. Steel or brass tube nut.

Conformance:

Listed by Underwriter's Laboratories (available on special order) for fuel equipment, refrigeration and gas. Meets specifications and standards of ASA, ASME, SAE and MS (Military Standards).

How to Order:

Order individually by catalog number.

Note:

Refer to current price list for availability of cataloged items. Configurations and dimensions subject to change without notice. Additional information can be found in SAE J512.

Label Set:

W-8022 (adhesive)
CL-490 (non-adhesive)

Assembly Instructions:

1. Cut tubing to desired length. Make sure all burrs are removed and the ends are cut square.
2. Slide nut on tube. Threaded end "A" of nut must face out.
3. Flare end of tube with a 45° flaring tool. See page 20 for flare data.
 - a. Measure flare diameter.
 - b. Examine flare for excessive thin out.
 - c. On thin wall, welded or brazed tubing, use double flare to prevent pinch-off and cracked flares.
4. Lubricate threads and assemble to connector body. Nut should be turned hand tight.
5. Tighten assembly with a wrench until a solid feeling is encountered. From that point, apply a one-sixth turn.

Note:

Do not over-torque as it may damage the connectors or split the tubing at the flare.

Brass Products

Inverted Flare

Tube Nut

(Steel)
(Ref. SAE No. 040110)

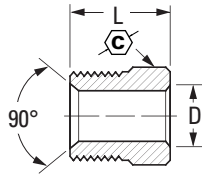

Tube Nut

(Brass)
(Ref. SAE No. 040110)

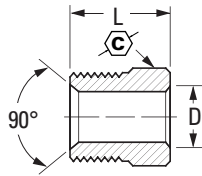
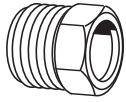

Plug

(Steel)
(Ref. SAE No. 040109)

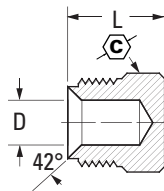
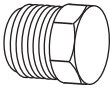

Tube Nut Long

(Steel)

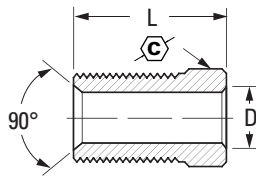
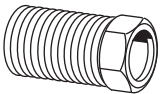

Required for wheel cylinders with deep port connection.

Union

(Ref. SAE No. 040101)

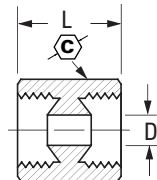
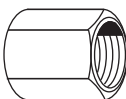

TUBE O.D.	CATALOG NUMBER		D	L
1/8	105x2	5/16	.132	.52
3/16	105x3	3/8	.196	.56
1/4	105x4	7/16	.259	.56
5/16	105x5	1/2	.321	.62
3/8	105x6	5/8	.384	.66
3/8	105x6x7*	11/16	.387	.66
7/16	105x7	11/16	.444	.68
1/2	105x8	3/4	.508	.74
5/8	105x10	7/8	.632	.80
3/4	105x12	1-1/16	.757	.88
7/8	105x14	1-3/16	.882	1.06
1	105x16	1-3/8	1.008	1.18

*3/8" Tube to 11/16-18 Male Thread

TUBE O.D.	CATALOG NUMBER		D	L
3/16	100x3	3/8	.196	.56
1/4	100x4	7/16	.259	.56
5/16	100x5	1/2	.321	.62
3/8	100x6	5/8	.384	.66
1/2	100x8	3/4	.508	.74

TUBE O.D.	CATALOG NUMBER		D	L
3/16	131x3	3/8	.188	.53
1/4	131x4	7/16	.188	.54
5/16	131x5	1/2	.250	.59
3/8	131x6	5/8	.312	.66

TUBE O.D.	CATALOG NUMBER		D	L
3/16	7896x3	3/8	.196	.844
1/4	7896x4	7/16	.257	.812

TUBE O.D.	CATALOG NUMBER		D	L
1/8	302x2	13/32	.078	.59
3/16	302x3	15/32	.125	.62
1/4	302x4	17/32	.188	.62
5/16	302x5	19/32	.219	.70
3/8	302x6	3/4	.281	.80
1/2	302x8	29/32	.406	.91
5/8	302x10♦	1-1/16	.531	.97

♦MTO - Made To Order

Brass Products

Inverted Flare

Adapter SAE 45° Flare to Inv. Flare

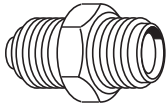

SAE TUBE SIZE	INVERTED MALE	CATALOG NUMBER		D	L
1/4	3/16	1518	7/16	.189	1.031
1/4	1/4	1522	7/16	.188	1.031
3/8	5/16	1553	5/8	.234	1.340
3/8	3/8	1563	5/8	.282	1.380
3/8	7/16	1554	11/16	.282	1.400

Male Connector

(Ref. SAE No. 040102)

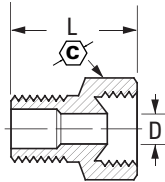
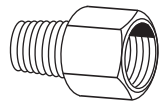

Pipe end drill may be reduced or increased from seat dimension 'D'.

TUBE O.D.	MALE PIPE THREAD	CATALOG NUMBER		D	L
1/8	1/8	202x2	13/32	.078	.62
3/16	1/8	202x3	15/32	.125	.70
1/4	1/8	202x4	17/32	.188	.74
1/4	1/4	202x4x4	9/16	.188	.89
5/16	1/8	202x5	19/32	.219	.79
5/16	1/4	202x5x4	19/32	.220	.98
3/8	1/8	202x6x2	3/4	.281	.89
3/8	1/4	202x6	3/4	.281	1.03
3/8	3/8	202x6x6	3/4	.281	1.01
1/2	1/4	202x8x4	29/32	.406	1.08
1/2	3/8	202x8	29/32	.406	1.07
1/2	1/2	202x8x8	29/32	.406	1.26
5/8	1/2	202x10	1-1/16	.531	1.32
3/4	3/4	202x12	1-1/4	.625	1.39
7/8	3/4	202x14	1-3/8	.750	1.38
1	1	202x16♦	1-1/2	.812	1.62

♦MTO - Made To Order

Female Connector

(Ref. SAE No. 040103)

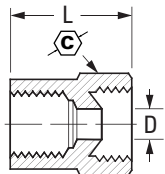
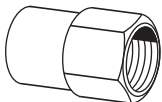

TUBE O.D.	FEM. PIPE THREAD	CATALOG NUMBER		D	L
3/16	1/8	252x3	1/2	.125	.75
1/4	1/8	252x4	17/32	.188	.75
5/16	1/8	252x5	19/32	.219	.78
3/8	1/4	252x6♦	3/4	.281	1.03
1/2	3/8	252x8♦	29/32	.406	1.09

♦MTO - Made To Order

45° Male Elbow

(Ref. SAE No. 040302)

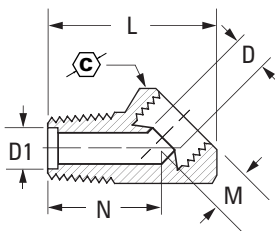
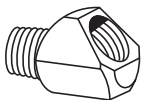

TUBE O.D.	MALE PIPE THREAD	CATALOG NUMBER		D	D1	L	M	N
3/16	1/8	352x3	17/32	.125	.156	.88	.25	.55
1/4	1/8	352x4	9/16	.188	.188	.94	.27	.58
5/16	1/8	352x5	5/8	.219	.203	1.00	.34	.56
5/16	1/4	352x5x4♦	5/8	.219	.203	1.16	.23	.83
3/8	1/4	352x6	25/32	.281	.219	1.34	.41	.84
1/2	3/8	352x8♦	7/8	.406	.375	1.44	.38	.91

♦MTO - Made To Order

Brass Products

Inverted Flare

90° Union Elbow

(Ref. SAE No. 040201)

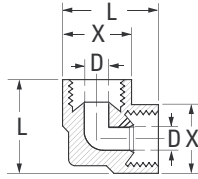
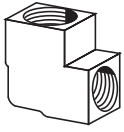

TUBE O.D.	CATALOG NUMBER	D	L	X
1/4	502x4	.188	.77	.53
5/16	502x5♦	.219	.86	.59
3/8	502x6♦	.281	1.04	.72

♦MTO - Made To Order

90° Male Elbow

(Ref. SAE No. 040202)

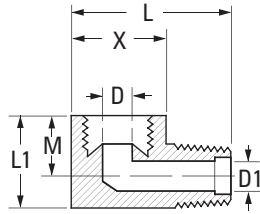
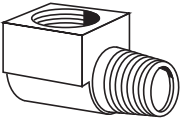

TUBE O.D.	MALE PIPE THREAD	CATALOG NUMBER	D	D1	L	L1	M	X
1/8	1/8	402x2	.078	.116	.80	.47	.27	.42
3/16	1/8	402x3	.125	.125	.85	.47	.27	.47
1/4	1/8	402x4	.188	.177	.92	.55	.33	.53
1/4	1/8	431x4*	.188	.062	.91	.53	.33	.53
1/4	1/4	402x4x4	.188	.188	1.09	.58	.28	.56
5/16	1/8	402x5	.219	.219	.98	.67	.47	.59
5/16	1/4	402x5x4	.219	.219	1.16	.75	.45	.59
5/16	3/8	402x5x6♦	.219	.219	1.15	.69	.34	.59
3/8	1/8	402x6x2	.281	.219	1.14	.75	.54	.76
3/8	1/4	402x6	.281	.281	1.32	.82	.53	.76
3/8	3/8	402x6x6	.281	.312	1.32	.84	.50	.75
1/2	1/4	402x8x4♦	.406	.281	1.47	.94	.59	.91
1/2	3/8	402x8	.406	.375	1.48	.94	.59	.92
1/2	1/2	402x8x8	.406	.406	1.67	1.09	.66	.91
5/8	3/8	402x10x6♦	.531	.437	1.62	1.11	.67	1.06
5/8	1/2	402x10♦	.531	.500	1.82	1.11	.67	1.06
3/4	1/2	402x12x8	.625	.531	2.01	1.30	.80	1.25
7/8	3/4	402x14	.750	.750	2.12	1.46	.94	1.38
1	1	402x16	.812	.812	2.44	1.70	1.02	1.50

*.062 dia. restricted hole through pipe end. Available on special order with any restricted hole size up to .172 dia.

♦MTO - Made To Order

90° Female Elbow

(Ref. SAE No. 040203)

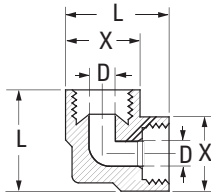
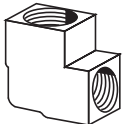

TUBE O.D.	FEM. PIPE THREAD	CATALOG NUMBER	D	L	X
3/16	1/8	452x3♦	.125	.81	.50
1/4	1/8	452x4	.188	.81	.53
5/16	1/8	452x5	.219	.88	.59
3/8	1/4	452x6	.281	1.05	.75

♦MTO - Made To Order

Brass Products

Inverted Flare

Union Tee

(Ref. SAE No. 040401)

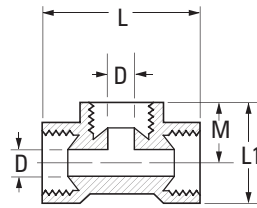
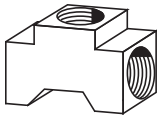

TUBE O.D.	CATALOG NUMBER	D	L	L1	M
1/8	702x2	.078	.94	.53	.330
3/16	702x3	.125	1.09	.62	.390
1/4	702x4	.188	1.13	.69	.420
5/16	702x5	.219	1.25	.75	.450
3/8	702x6	.281	1.48	.94	.560
7/8	702x14	.750	2.37	1.62	.937

Male Run Tee

(Ref. SAE No. 040424)

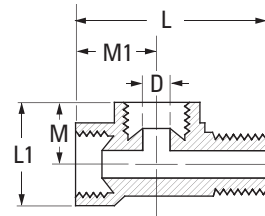
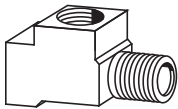

TUBE O.D.	MALE PIPE THREAD	CATALOG NUMBER	D	L	L1	M	M1
3/16	1/8	752x3♦	.125	1.25	.62	.39	.53
1/4	1/8	752x4	.188	1.31	.69	.42	.56
5/16	1/8	752x5♦	.219	1.47	.75	.45	.62
3/8	1/4	752x6♦	.281	1.83	.94	.56	.75
1/2	3/8	752x8♦	.406	.406	1.39	1.47	.91

♦MTO - Made To Order

Male Branch Tee

(Ref. SAE No. 040425)

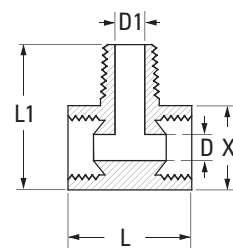
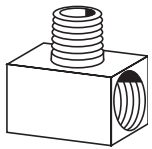

TUBE O.D.	MALE PIPE THREAD	CATALOG NUMBER	D	D1	L	L1	X
3/16	1/8	602x3	.125	.219	.82	.84	.47
1/4	1/8	602x4	.188	.219	.84	.91	.53
5/16	1/8	602x5	.219	.219	.95	.97	.59
3/8	1/4	602x6	.281	.344	1.16	1.31	.75
1/2	3/8	602x8♦	.406	.406	1.39	1.47	.91

♦MTO - Made To Order

Female Branch Tee

(Ref. SAE No. 040427)

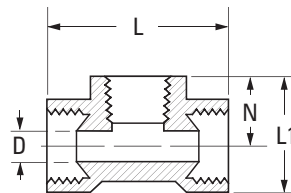
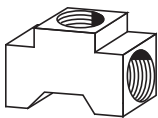

TUBE O.D.	FEM. PIPE THREAD	CATALOG NUMBER	D	L	L1	N
3/16	1/8	652x3	.125	1.10	.62	.39
1/4	1/8	652x4♦	.188	1.12	.69	.42
5/16	1/8	652x5♦	.219	1.26	.75	.45
1/2	3/8	652x8♦	.406	1.75	1.12	.67

♦MTO - Made To Order

Brass Products

SAE 45° Flare

Note:
For additional technical questions, contact Technical Support at 1-888-258-0222.

 Refer to safety information regarding proper selection of tubing and tube connectors on page 1.

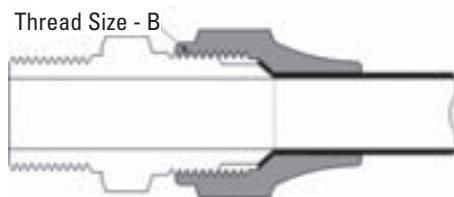
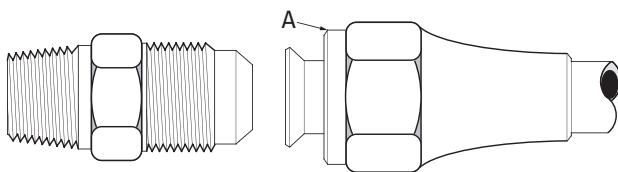

Tube O.D.	1/8	3/16	1/4	5/16	3/8	7/16	1/2	5/8	3/4
Thread Size-B	5/16-24	3/8-24	7/16-20	1/2-20	5/8-18	11/16-18	3/4-16	7/8-14	1-1/16-14

Typical Application:

LP and natural gas, flammable liquids (special order), instrumentation, refrigeration, power steering, hydraulic and pneumatic systems.

Pressure:

Working pressure up to 2000 psi depending on tube size. Will withstand burst pressure of standard tubing - up to 5000 psi with Bundy-weld (double flared) and 3500 psi with copper tubing, depending on size.

Vibration:

Good resistance - use long nut when greater vibration resistance is required.

Temperature Range:

-65°F to +250°F (-53°C to +121°C) range at maximum operating pressures.

Material:

CA360 Brass.

Used With:

Copper, brass, aluminum and steel hydraulic tubing that can be flared.

See pages 22-26 for material compatibility.

Advantages:

Low cost and reusability, long or short nut. Good resistance to vibration.

Conformance:

Listed by Underwriter's Laboratories (available on special order) for flammable liquids, refrigeration and gas. Meets specifications and standards of ASA, ASME, SAE and MS (Military Standards).

How to Order:

Order individually by catalog number.

Note:

Refer to current price list for availability of cataloged items. Configurations and dimensions subject to change without notice. Quotations of non-stock items available upon request. Additional information can be found in SAE J512.

Assembly Instructions:

1. Cut tubing to desired length. Make sure all burrs are removed and the ends are cut square.
2. Slide nut on tube. Threaded end "A" of nut must face out.
3. Flare end of tube with a 45° flaring tool. See page 20 for flare data.
 - a. Measure flare diameter.
 - b. Examine flare for excessive thin out.
4. Lubricate threads and assemble to connector body. Nut should be turned hand tight.
5. Tighten assembly with a wrench until a solid feeling is encountered. From that point, apply a one-sixth turn.

Note:

Do not over-torque as it may damage the connector or split the tubing at the flare.

Label Set:

W-8022 (adhesive)
CL-490 (non-adhesive)

Brass Products

SAE 45° Flare

Nut

(Ref. SAE No. 010110)

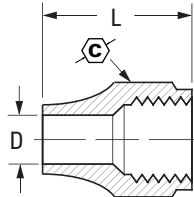
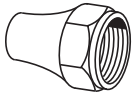

TUBE O.D.	CATALOG NUMBER		D	L
1/8	1110x2	3/8	.133	.50
3/16	1110x3	7/16	.195	.62
1/4	1110x4	9/16	.258	.75
5/16	1110x5	5/8	.320	.88
3/8	1110x6	3/4	.383	1.00
7/16	1110x7♦	13/16	.445	1.06
1/2	1110x8	7/8	.508	1.12
5/8	1110x10	1-1/16	.633	1.31
3/4	1110x12♦	1-1/4	.758	1.50

♦MTO - Made To Order

Long Nut

(Ref. SAE No. 010111)

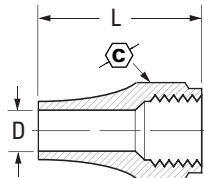
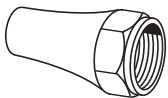

TUBE O.D.	CATALOG NUMBER		D	L
3/16	41x3	7/16	.195	.81
1/4	41x4	9/16	.258	.94
5/16	41x5	5/8	.320	1.12
3/8	41x6	3/4	.383	1.31
1/2	41x8	7/8	.508	1.62
5/8	41x10♦	1-1/16	.633	1.88

♦MTO - Made To Order

Cap

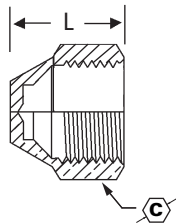
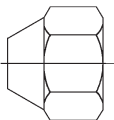

TUBE O.D.	CATALOG NUMBER		L
1/8	40x2	7/16	.40
3/16	40x3	1/2	.47
1/4	40x4	7/16	.53
5/16	40x5	5/8	.62
3/8	40x6	3/4	.69
1/2	40x8	7/8	.84
5/8	40x10	1-1/16	.97
3/4	40x12	1-5/16	1.09

Plug

(Ref. SAE No. 010109)

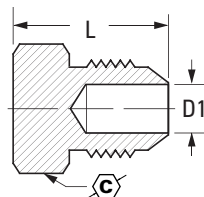
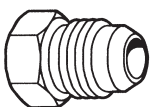

TUBE O.D.	CATALOG NUMBER		L	D1 (OPT.)
1/8	39x2	5/16	.47	.079
3/16	39x3	3/8	.58	.126
1/4	39x4	7/16	.69	.189
5/16	39x5	1/2	.79	.220
3/8	39x6	5/8	.88	.282
1/2	39x8	3/4	1.06	.408
5/8	39x10	7/8	1.19	.502
3/4	39x12	1-1/16	1.31	.627

Union

(Ref. SAE No. 010101)

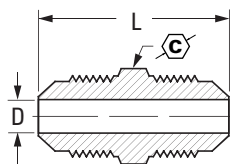
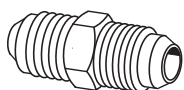

TUBE O.D.	CATALOG NUMBER		D	L
1/8	42x2♦	5/16	.078	.92
3/16	42x3	3/8	.125	1.06
1/4	42x4	7/16	.188	1.19
5/16	42x5	1/2	.219	1.34
3/8	42x6	5/8	.281	1.50
1/2	42x8	3/4	.406	1.81
5/8	42x10	7/8	.500	2.12
3/4	42x12♦	1-1/16	.625	2.44

♦MTO - Made To Order

Brass Products

SAE 45° Flare

Male Connector

(Ref. SAE No. 010102)

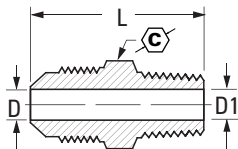
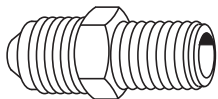

*Counterbore is optional.

TUBE O.D.	FEM. PIPE THREAD	CATALOG NUMBER	C	D	L	L1
1/8	1/8	48x2	7/16	.078	.219	.90
3/16	1/8	48x3	7/16	.125	.219	1.00
1/4	1/8	48x4	7/16	.188	.188	1.06
1/4	1/4	48x4x4	9/16	.188	.312	1.26
5/16	1/8	48x5	1/2	.219	.219	1.16
5/16	1/4	48x5x4	9/16	.219	.219	1.34
3/8	1/8	48x6x2	5/8	.281	.219	1.25
3/8	1/4	48x6	5/8	.281	.281	1.44
3/8	3/8	48x6x6	11/16	.281	.281	1.44
3/8	1/2	48x6x8	7/8	.281	.562*	1.69
1/2	1/4	48x8x4	3/4	.406	.312	1.62
1/2	3/8	48x8	3/4	.406	.406	1.62
1/2	1/2	48x8x8	7/8	.406	.562	1.81
5/8	3/8	48x10x6	7/8	.500	.406	1.81
5/8	1/2	48x10	7/8	.500	.500	2.00
3/4	1/2	48x12	1-1/16	.625	.562	2.18
3/4	3/4	48x12x12	1-1/16	.625	.625	2.18

Female Connector

(Ref. SAE No. 010103)

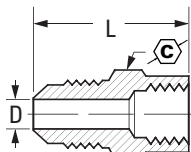
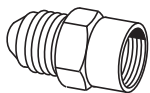

TUBE O.D.	FEM. PIPE THREAD	CATALOG NUMBER	C	D	L
3/16	1/8	46x3♦	9/16	.125	.97
1/4	1/8	46x4	9/16	.188	1.03
1/4	1/4	46x4x4	11/16	.188	1.25
5/16	1/8	46x5	9/16	.219	1.06
5/16	1/4	46x5x4♦	11/16	.219	1.28
3/8	1/4	46x6	11/16	.281	1.31
3/8	3/8	46x6x6	13/16	.281	1.38
3/8	1/2	46x6x8♦	1	.281	1.62
1/2	3/8	46x8	13/16	.406	1.50
1/2	1/2	46x8x8♦	1	.406	1.75
5/8	3/8	46x10x6♦	7/8	.500	1.59
5/8	1/2	46x10♦	1	.500	1.81
5/8	3/4	46x10x12♦	1-1/4	.500	1.90

♦MTO - Made To Order

Male Ball Check Connector

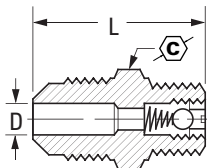
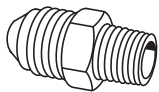

Ball & Spring position may be reversed to change flow/check direction. Min pressure 3 psi.

TUBE O.D.	MALE PIPE THREAD	CATALOG NUMBER	C	D	L
1/4	1/8	43x4	7/16	.125	1.06
3/8	1/4	43x6	5/8	.219	1.31

45° Male Elbow

(Ref. SAE No. 010302)

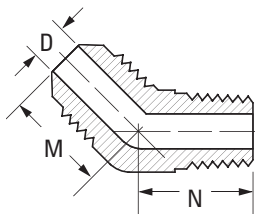
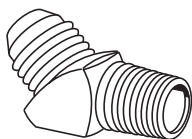

TUBE O.D.	MALE PIPE THREAD	CATALOG NUMBER	D	M	N
1/4	1/8	54x4	.188	.67	.64
1/4	1/4	54x4x4	.188	.73	.87
5/16	1/8	54x5	.219	.78	.64
3/8	1/4	54x6	.281	.89	.86
1/2	3/8	54x8	.406	1.06	.95
1/2	1/2	54x8x8	.406	1.12	1.17
5/8	3/8	54x10x6	.500	1.23	.98
5/8	1/2	54x10	.500	1.23	1.17

Brass Products

SAE 45° Flare

AC Type Adapter

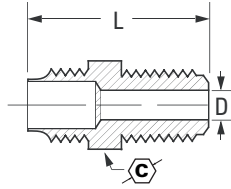
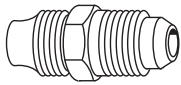

TUBE SIZE	SAE TUBE SIZE	CATALOG NUMBER		D	L
1/4	1/4	1521	7/16	.188	1.094

Adapter SAE 45° Flare to Inv. Flare

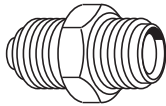

SAE TUBE SIZE	INVERTED MALE	CATALOG NUMBER		D	L
1/4	3/16	1518	7/16	.189	1.031
1/4	1/4	1522	7/16	.188	1.031
3/8	5/16	1553	5/8	.234	1.340
3/8	3/8	1563	5/8	.282	1.380
3/8	7/16	1554	11/16	.282	1.400

90° Union Elbow

(Ref. SAE No. 010201)

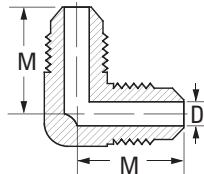
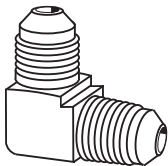

TUBE O.D.	CATALOG NUMBER	D	M
1/2	55x8	.406	1.20
3/4	55x12♦	.625	1.64

♦MTO - Made To Order

90° Male Elbow

(Ref. SAE No. 010202)

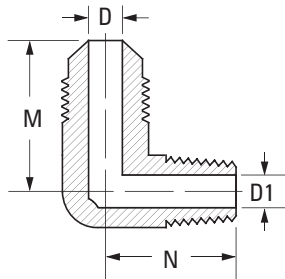
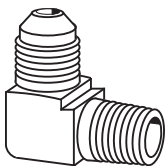

TUBE O.D.	MALE PIPE THREAD	CATALOG NUMBER	D	D1	M	N
1/8	1/8	49x2	.078	.219	.62	.69
3/16	1/8	49x3	.125	.219	.75	.75
1/4	1/8	49x4	.188	.219	.81	.76
1/4	1/4	49x4x4	.188	.312	.88	.94
1/4	3/8	49x4x6	.188	.375	.94	1.03
5/16	1/8	49x5	.219	.219	.91	.78
5/16	1/4	49x5x4	.219	.312	.95	.92
3/8	1/8	49x6x2	.281	.219	1.03	.91
3/8	1/4	49x6	.281	.312	.97	1.06
3/8	3/8	49x6x6	.281	.406	1.06	1.09
3/8	1/2	49x6x8	.281	.438	1.16	1.28
1/2	1/4	49x8x4	.406	.281	1.22	1.19
1/2	3/8	49x8	.406	.406	1.22	1.12
1/2	1/2	49x8x8	.406	.406	1.26	1.35
5/8	3/8	49x10x6	.500	.410	1.41	1.23
5/8	1/2	49x10	.500	.562	1.41	1.38
3/4	1/2	49x12	.625	.531	1.62	1.50
3/4	3/4	49x12x12	.625	.750	1.59	1.62

90° Female Elbow

(Ref. SAE No. 010203)

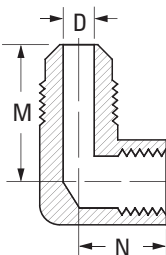
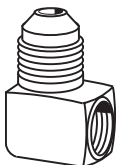

TUBE O.D.	FEM. PIPE THREAD	CATALOG NUMBER	D	M	N
1/4	1/8	50x4	.188	.88	.47
1/4	1/4	50x4x4	.188	.97	.66
3/8	1/4	50x6	.281	1.09	.69

♦MTO - Made To Order

Brass Products

SAE 45° Flare

Union Tee

(Ref. SAE No. 010401)

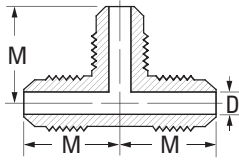
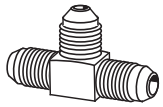

TUBE O.D.	CATALOG NUMBER	D	M
3/16	44x3♦	.125	.73
1/4	44x4	.188	.86
3/8	44x6♦	.281	1.04
1/2	44x8	.406	1.20

♦MTO - Made To Order

Male Run Tee

(Ref. SAE No. 010424)

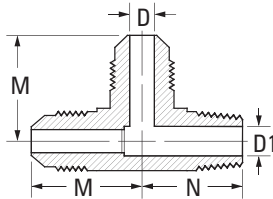
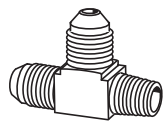

TUBE O.D.	MALE PIPE THREAD	CATALOG NUMBER	D	D1 OPT.	M	N
1/4	1/8	51x4	.188	.219	.86	.76

♦MTO - Made To Order

Male Branch Tee

(Ref. SAE No. 010425)

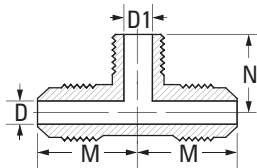
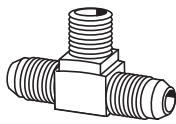

TUBE O.D.	MALE PIPE THREAD	CATALOG NUMBER	D	D1	M	NP
1/4	1/8	45x4	.188	.219	.81	.78
1/4	1/4	45x4x4x4♦	.188	.312	.91	.94
3/8	3/8	45x6x6x6♦	.281	.406	1.06	1.09
1/2	3/8	45x8♦	.406	.406	1.22	1.12
1/2	1/2	45x8x8x8♦	.406	.562	1.28	1.38
3/4	1/2	45x12♦	.625	.562	1.62	1.50

♦MTO - Made To Order

Adapter Tee

(Female to Male Pipe on Run)

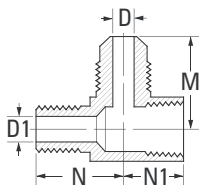
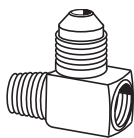

TUBE O.D.	MALE PIPE THREAD	CATALOG NUMBER	D	D1	M	N	N1
1/4	1/8	56x4♦	.188	.188	.78	.76	.46

♦MTO - Made To Order

Brass Products

Compression

Note:
For additional technical questions, contact Technical Support at 1-888-258-0222.

 Refer to safety information regarding proper selection of tubing and tube connectors on page 1.

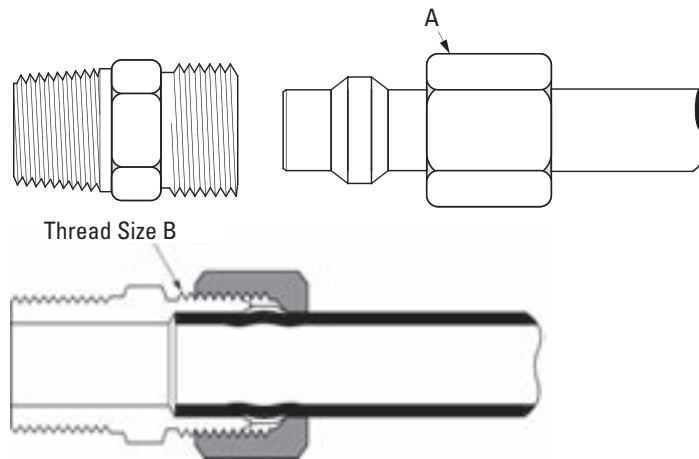

Tube O.D.	1/8	3/16	1/4	5/16	3/8	7/16	1/2	5/8	3/4	1
Thread Size-B	5/16-24	3/8-24	7/16-24	1/2-24	9/16-24	5/8-24	11/16-20	13/16-18	1-18	1-1/4-18

Typical Application:

Instrumentation, hydraulic and pneumatic systems.

Pressure:

Working pressure up to 2000 psi with a 4:1 safety factor depending on tube size. When using plastic tubing, use the working pressure for type used.

Vibration:

Fair resistance - use long nut when greater vibration resistance is needed.

Temperature Range:

65°F to +250°F (-53°C to +121°C) with metal tubing. When using compatible plastic tubing do not exceed the tubing temperature range. (Refer to tubing temperature range.)

Material:

CA360 Brass.

Used With:

Aluminum, copper and plastic tubing.

Plastic tubing, except for PT230 and TP160, requires 2030x insert. Not recommended for steel tubing. See pages 22-26 for material compatibility, and pages 27-29 for plastic tubing.

Advantages:

Low cost. Easy to assemble, no flaring. Available with long or short nut. Broad selection of styles and sizes.

Conformance:

Listed by Underwriter's Laboratories (available on special order) for flammable liquids. Meets specifications and standards of ASA, ASME and SAE.

How to Order:

Compression connectors are ordered as complete assemblies (body, nut and sleeve). To order assembly supplied with long nuts, simply add the prefix "1" to the catalog number. Example: 68x4 with long nut becomes 168x4. Nuts and sleeves can be ordered separately by catalog number. To order bodies only (less nut and sleeve), prefix catalog number with letter "B". Example: B68x4.

Note:

Refer to current price list for availability of cataloged items. Quotations and delivery of non-stock items supplied on request. Configurations and dimensions subject to change without notice. Additional information can be found in SAE J512.

Assembly Instructions:

1. Cut tubing to desired length.
2. Slide nut and then sleeve on tube. Threaded end "A" of nut must face toward connector.
3. Insert tubing into connector body. Be sure tubing is bottomed on connector shoulder.
4. Lubricate threads and assemble nut to connector body.
5. Tighten nut hand tight. From that point, tighten with a wrench the number of turns indicated in the chart below.

TUBE SIZE	ADDITIONAL TURNS FROM HAND TIGHT
1/8" thru 1/4"	1-1/4
5/16"	1-3/4
3/8" thru 1"	2-1/4

Label Set:

W-8022 (adhesive)
CL-490 (non-adhesive)

Brass Products

Compression

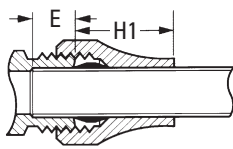
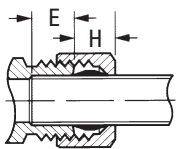

H and H1 are hand tight dimensions.

TUBE O.D.	E TUBE STOP DEPTH	H	H1 (LONG NUT)
1/8	.19	.23	—
3/16	.22	.25	.47
1/4	.25	.29	.56
5/16	.28	.30	.66
3/8	.31	.27	.70
1/2	.38	.42	.88
5/8	.38	.42	.92
3/4	.44	.49	1.18

Tube Support for Plastic Tubing

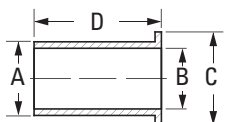

Use only with PT200 and PT240 Tubing.

TUBE O.D.	CATALOG NUMBER	DIA. A	DIA. B	DIA. C	LENGTH D
1/4	2030x4*	1/8	3/32	11/64	19/32
1/4	2030x44**	11/64	9/64	7/32	17/32
5/16	2030x5	3/16	5/32	15/64	5/8
3/8	2030x6	1/4	7/32	11/32	41/64
1/2	2030x8	3/8	11/32	7/16	13/16
5/8	2030x10	1/2	29/64	35/64	13/16
3/4	2030x12	9/16	33/64	11/16	1-1/32

* For Tubing with .126 I.D./ .062 wall thickness.

** For tubing with .170 I.D./ .040 wall thickness.

Compression Sleeve

(Ref. SAE No. 060115)

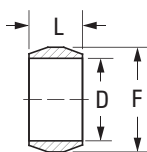

TUBE O.D.	CATALOG NUMBER	D	F	L
1/8	60x2	.13	.19	.19
3/16	60x3	.19	.27	.22
1/4	60x4	.26	.34	.25
5/16	60x5	.32	.41	.25
3/8	60x6	.38	.47	.25
7/16	60x7	.44	.53	.31
1/2	60x8	.51	.59	.38
5/8	60x10	.63	.72	.38
3/4	60x12♦	.76	.88	.44

♦MTO - Made To Order

Nut

(Ref. SAE No. 060110)

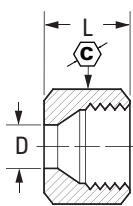
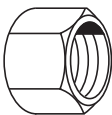

TUBE O.D.	CATALOG NUMBER	C	D	L
1/8	61x2	3/8	.13	.38
3/16	61x3	7/16	.19	.41
1/4	61x4	1/2	.26	.44
5/16	61x5	9/16	.32	.44
3/8	61x6	5/8	.38	.47
7/16	61x7	11/16	.44	.50
1/2	61x8	13/16	.51	.62
5/8	61x10	15/16	.63	.62
5/8	61x12♦	1-3/16	.76	.69

♦MTO - Made To Order

Brass Products

Compression

Long Nut

(Ref. SAE No. 060111)

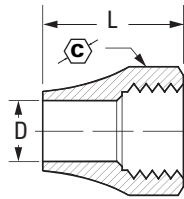
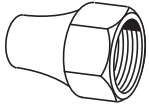

TUBE O.D.	CATALOG NUMBER		D	L
3/16	1611x3		.193	.62
1/4	1611x4		.260	.75
5/16	1611x5♦		.320	.84
3/8	1611x6		.380	.88
1/2	1611x8♦		.510	1.06
5/8	1611x10♦		.637	1.08
3/4	1611x12♦		.760	1.38

♦MTO - Made To Order

Bulkhead Nut



Used on 74x Bulkhead Unions. Ref. page 44.

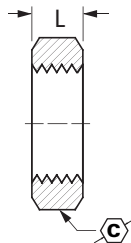

TUBE O.D.	CATALOG NUMBER		L	THREAD SIZE
1/4	0102x4		.25	7/16-24
5/16	0102x5		.25	1/2-24
3/8	0102x6		.25	9/16-24
1/2	0102x8		.38	11/16-20

Union

(Ref. SAE No. 060101BA)

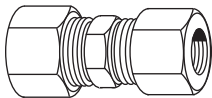

Assembly with long nut 162x.
Not available in the x3 style.

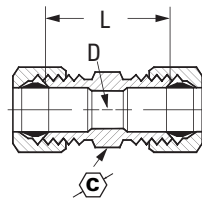

TUBE O.D.	CATALOG NUMBER		D	L
1/8	62x2		.094	.66
3/16	62x3		.125	.76
1/4	62x4		.188	.79
5/16	62x5		.250	.88
3/8	62x6		.312	.97
1/2	62x8		.406	1.10
5/8	62x10		.500	1.25
3/4	62x12♦		.562	1.44

♦MTO - Made To Order

Male Connector

(Ref. SAE No. 060102BA)

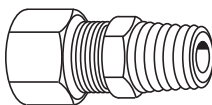

Assembly with long nut 168x.

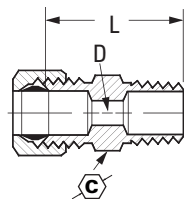

TUBE O.D.	MALE PIPE THREAD	CATALOG NUMBER		D	D1 OPT.	L
1/8	1/16	68x2x1	3/8	.094	—	.78
1/8	1/8	68x2	7/16	.094	.094	.78
3/16	1/8	68x3	7/16	.125	.125	.84
1/4	1/8	68x4	7/16	.188	.188	.88
1/4	1/4	68x4x4	9/16	.188	.312	1.06
5/16	1/8	68x5	1/2	.250	.234	.91
5/16	1/4	68x5x4	9/16	.250	.250	1.09
3/8	1/8	68x6x2	9/16	.312	.250	.97
3/8	1/4	68x6	9/16	.312	.312	1.17
3/8	3/8	68x6x6	11/16	.312	.312	1.16
3/8	1/2	68x6x8	7/8	.312	.562	1.34
1/2	1/4	68x8x4	11/16	.406	.281	1.22
1/2	3/8	68x8	11/16	.406	.406	1.22
1/2	1/2	68x8x8	7/8	.406	.406	1.41
5/8	1/2	68x10	7/8	.500	.500	1.50
3/4	1/2	68x12♦	1	.562	.562	1.62
3/4	3/4	68x12x12♦	1-1/16	.562	.875	1.62

♦MTO - Made To Order

Brass Products

Compression

Female Connector

(Ref. SAE No. 060103BA)

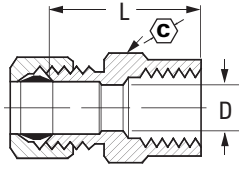
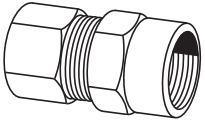

Assembly with long nut 166x.

Male Ball Check Connector

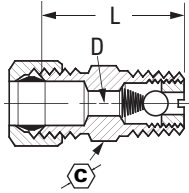
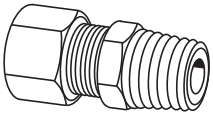

Assembly with long nut 163x. Min. working pressure 3 psi. Ball and spring position may be reversed to change flow/check direction. Ball check valves are neither tested nor adjusted prior to sale.

Bulkhead Union

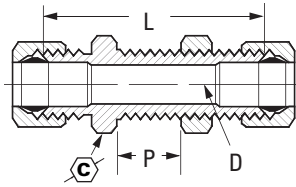
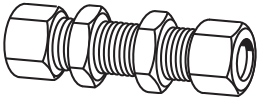

Assembly with long nut 174x. For Bulkhead Nuts, ref. page 43, included with assembly.

TUBE O.D.	FEM. PIPE THREAD	CATALOG NUMBER		D	L
1/8	1/8	66x2	9/16	.094	.75
3/16	1/8	66x3	9/16	.125	.78
1/4	1/8	66x4	9/16	.188	.78
1/4	1/4	66x4x4	11/16	.188	1.03
5/16	1/8	66x5	9/16	.250	.81
5/16	1/4	66x5x4♦	11/16	.250	1.03
3/8	1/8	66x6x2	9/16	.312	.84
3/8	1/4	66x6	11/16	.312	1.06
1/2	3/8	66x8	13/16	.406	1.12

♦MTO - Made To Order

TUBE O.D.	MALE PIPE THREAD	CATALOG NUMBER		D	L
1/4	1/8	63x4	7/16	.125	.88
3/8	1/4	63x6	9/16	.219	1.16

TUBE O.D.	CATALOG NUMBER		D	L	MAX. P
1/4	74x4	9/16	.188	1.57	.52
3/8	74x6♦	11/16	.312	1.76	.55

♦MTO - Made To Order

Brass Products

Compression

90° Male Elbow

(Ref. SAE No. 060202BA)

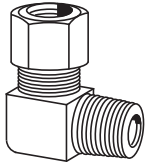

Assembly with long nut 169x.

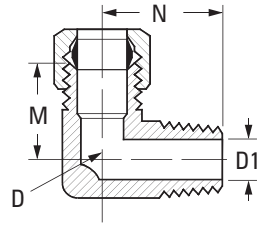

TUBE O.D.	MALE PIPE THREAD	CATALOG NUMBER	D	D1	M	N
1/8	1/16	69x2x1	.104	.125	.54	.66
1/8	1/8	69x2	.094	.219	.60	.67
3/16	1/8	69x3	.125	.219	.62	.69
1/4	1/8	69x4	.188	.219	.62	.75
1/4	1/4	69x4x4	.188	.188	.62	.75
5/16	1/8	69x5	.250	.234	.62	.75
5/16	1/4	69x5x4	.250	.312	.69	.84
3/8	1/8	69x6x2	.312	.234	.69	.69
3/8	1/4	69x6	.312	.344	.75	.94
3/8	3/8	69x6x6	.312	.438	.84	.94
3/8	1/2	69x6x8	.312	.531	1.06	1.12
7/16	1/4	69x7♦	.312	.312	.84	1.00
1/2	1/4	69x8x4	.406	.312	.84	.94
1/2	3/8	69x8	.406	.406	.94	1.12
1/2	1/2	69x8x8	.406	.531	.94	1.31
5/8	1/2	69x10	.500	.562	1.06	1.31
3/4	1/2	69x12♦	.562	.562	1.19	1.50
3/4	3/4	69x12x12♦	.562	.562	1.19	1.31

♦MTO - Made To Order

90° Union Elbow

(Ref. SAE No. 060201BA)

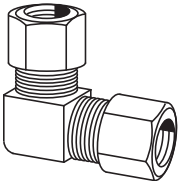

Assembly with long nut 165x.

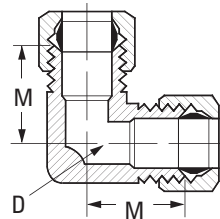

TUBE O.D.	CATALOG NUMBER	D	M
1/4	65x4	.188	.60
5/16	65x5	.250	.62
3/8	65x6	.312	.73
1/2	65x8	.406	.94

90° Female Elbow

(Ref. SAE No. 060203BA)

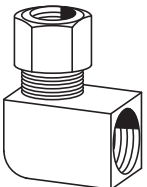

Assembly with long nut 170x.

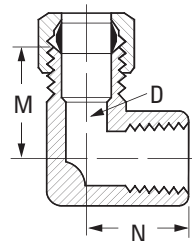

TUBE O.D.	FEM. PIPE THREAD	CATALOG NUMBER	D	M	N
3/16	1/8	70x3	.125	.69	.56
1/4	1/8	70x4	.188	.69	.56
3/8	1/4	70x6♦	.312	.81	.75
1/2	3/8	70x8♦	.406	1.00	.88

♦MTO - Made To Order

Brass Products

Compression

Union Tee

(Ref. SAE No. 060401BA)

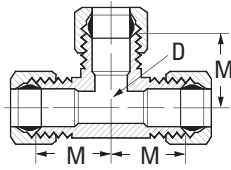
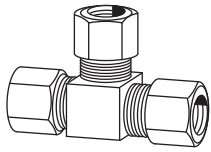

Assembly with long nut 164x.

TUBE O.D.	CATALOG NUMBER	D	M
3/16	64x3	.125	.60
1/4	64x4	.188	.62
5/16	64x5	.250	.60
3/8	64x6	.312	.73
1/2	64x8	.406	.94

Male Run Tee

(Ref. SAE No. 060424BA)

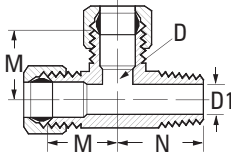
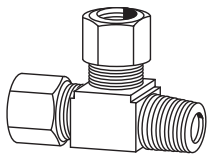

Assembly with long nut 171x.

TUBE O.D.	MALE PIPE THREAD	CATALOG NUMBER	D	D1	M	N
3/16	1/8	71x3	.125	.219*	.64	.68
1/4	1/8	71x4	.188	.219*	.64	.73
3/8	1/4	71x6	.312	.344*	.75	.94

*Optional Counterbore.

Male Branch Tee

(Ref. SAE No. 060425BA)

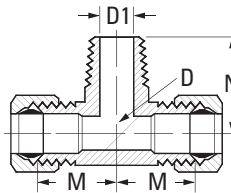
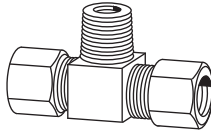

Assembly with long nut 172x.

TUBE O.D.	MALE PIPE THREAD	CATALOG NUMBER	D	D1	M	N
3/16	1/8	72x3♦	.125	.219	.62	.69
1/4	1/8	72x4	.188	.219	.64	.73
1/4	1/4	72x4x4x4	.188	.281	.78	.85
5/16	1/8	72x5	.250	.234	.66	.70
3/8	1/4	72x6	.312	.344	.78	.91
1/2	3/8	72x8	.406	.406	.96	1.09

♦MTO - Made To Order

Adapter Tee

(Female to Male Pipe on Run)

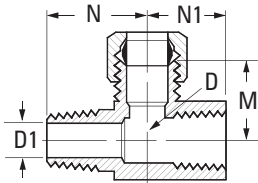
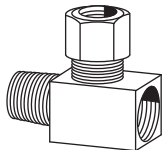

TUBE O.D.	M&F PIPE THREAD	CATALOG NUMBER	D	D1	M	N	N1
1/4	1/8	76x4♦	.188	.219	.59	.63	.47

♦MTO - Made To Order

Brass Products

Selfalign

Note:
For additional technical questions, contact Technical Support at 1-888-258-0222.

 Refer to safety information regarding proper selection of tubing and tube connectors on page 1.

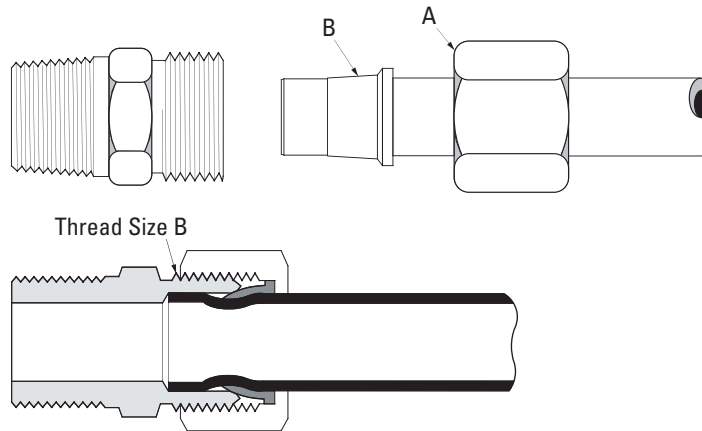

Tube O.D.	1/8	3/16	1/4	5/16	3/8	7/16	1/2	5/8	3/4	1
Thread Size-B	5/16-24	3/8-24	7/16-24	1/2-24	9/16-24	5/8-24	11/16-20	13/16-18	1-18	1-1/4-18

Typical Application:

Instrumentation, hydraulic and pneumatic systems.

Pressure:

Working pressure up to 2000 psi with a 4:1 safety factor depending on tube size. When using plastic tubing, use the working pressure for type used.

Vibration:

Good resistance - use long nut when greater vibration resistance is needed.

Temperature Range:

-65°F to +250°F (-53°C to +121°C) with metal tubing. When using compatible plastic tubing do not exceed the tubing temperature range. (Refer to tubing temperature range.)

Material:

CA360 Brass.

Used with:

Aluminum, copper and plastic tubing.

Plastic tubing, except for PT230 and TP160, requires 2030x insert. Not recommended for steel tubing. See pages 22-26 for material compatibility, and pages 27-29 for plastic tubing.

Advantages:

Very low cost and reusable. Self aligning - no need to disassemble fitting to line up sleeve on tube. Low cost. Easy to assemble, no flaring. Available with long or short nut. Broad selection of styles and sizes.

Conformance:

An exclusive product design, user approvals only.

How to Order:

Selfalign connectors are ordered as complete assemblies (body, nut and sleeve). To order assembly supplied with long nuts, simply add the prefix "1" to the catalog number. Example: 681x4 with long nut becomes 1681x4. Nuts and sleeves can be ordered separately by catalog number. To order bodies only (less nut and sleeve), prefix catalog number with the letter "B" and drop suffix number. Example: B68x4.

Note:

Refer to current price list for availability of cataloged items. Quotations and delivery of non-stock items supplied on request. Configurations and dimensions subject to change without notice.

Assembly Instructions:

1. Cut tubing to desired length.
2. Slide nut and then sleeve on tube. Threaded end of nut "A" and small end of sleeve "B" must face toward fitting.
3. Insert tubing into connector body. Be sure tubing is bottomed on connector shoulder.
4. Lubricate threads and assemble nut to connector body.
5. Tighten with wrench to the "ring grip" point.
 - a. Ring Grip is the point when the cutting edge of the sleeve grips the tube. This is determined by turning tube slowly but firmly by hand while tightening the nut with a wrench until tube can no longer be turned by hand and a sharp increase in torque is noticed.
6. Tighten additional turns past "ring grip" as indicated on chart. Refer to page 48.

Label Set:

CL-500 (non-adhesive)

Brass Products

Selfalign

Selfalign Assembly

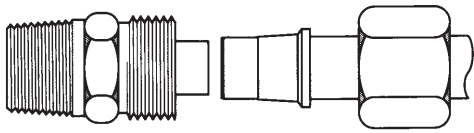

Ring Grip is the point when the cutting edge of the sleeve grips the tube. This is determined by turning tube slowly but firmly by hand while tightening the nut with a wrench until tube can no longer be turned by hand and a sharp increase in torque is noted.

Selfalign Assembly Data Chart

Fitting Size	ANNEALED COPPER AND SOFT ALUMINUM TUBING		NYLON TUBING			
	Wall	Turns*	Type "T" Thin Wall		Type "H" Thick Wall	
			Wall	Turns*	Wall	Turns*
2	.030	1-1/3	—	—	—	—
3	.030	1-1/3	.023	1-2/3	.039	1-1/3
4	.030	1-2/3	.030	2	.050	1-2/3
5	.032	1-2/3	.036	1-2/3	.062	2-2/3
6	.032	2	.040	1-2/3	.075	2
8	.032	2	—	—	—	—
10	.035	2	—	—	—	—
12	.049	2	—	—	—	—
16	.065	2-1/4	—	—	—	—

*Turns from "Ring Grip"

Nut Assembly Comparison

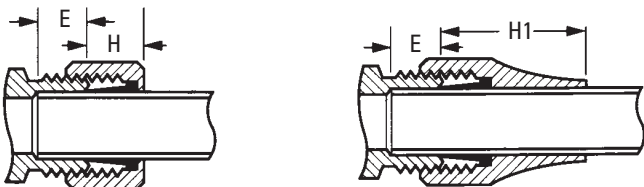

H and H1 are hand tight dimensions.

TUBE O.D.	E TUBE STOP DEPTH	H (STD. NUT)	H1 (LONG NUT)
1/8	.19	.24	—
3/16	.22	.25	.49
1/4	.25	.35	.61
5/16	.28	.30	.70
3/8	.31	.31	.75
1/2	.38	.36	.83
5/8	.38	.41	.92
3/4	.44	.41	1.14

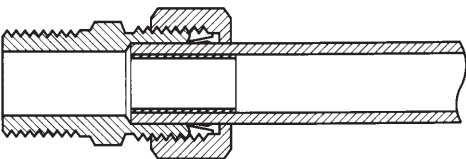

Selfalign fitting used with soft plastic tubing and brass insert.

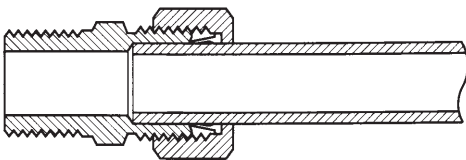

Selfalign fitting used on rigid plastic tubing, no insert.

Brass Products

Selfalign

Tube Supports for Plastic Tubing

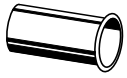

Use only with PT200 and PT240 Tubing.

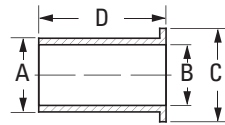

TUBE O.D.	CATALOG NUMBER	DIA. A	DIA. B	DIA. C	LENGTH D
1/4	2030x4*	1/8	3/32	11/64	19/32
1/4	2030x44**	11/64	9/64	7/32	17/32
5/16	2030x5	3/16	5/32	15/64	5/8
3/8	2030x6	1/4	7/32	11/32	41/64
1/2	2030x8	3/8	11/32	7/16	13/16
5/8	2030x10	1/2	29/64	35/64	13/16
3/4	2030x12	9/16	33/64	11/16	1-1/32

*For tubing with .126 I.D./ .062 wall.

**For tubing with .170 I.D./ .040 wall.

Sleeve

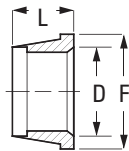

TUBE O.D.	CATALOG NUMBER	D	F	L
1/8	601x2	.130	.25	.20
3/16	601x3	.193	.31	.20
1/4	601x4	.256	.38	.26
5/16	601x5	.318	.44	.26
3/8	601x6	.381	.50	.26
1/2	601x8	.507	.62	.30
5/8	601x10	.630	.72	.36
3/4	601x12	.755	.88	.38
1	601x16	1.005	1.19	.50

Nut

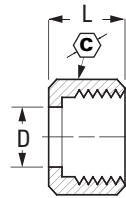

TUBE O.D.	CATALOG NUMBER	C	D	L
1/8	611x2	3/8	.14	.38
3/16	611x3	7/16	.19	.38
1/4	611x4	1/2	.26	.44
5/16	611x5	9/16	.32	.44
3/8	611x6	5/8	.38	.44
1/2	611x8	13/16	.51	.52
5/8	611x10	15/16	.64	.56
3/4	611x12	1-3/16	.76	.56

Long Nut

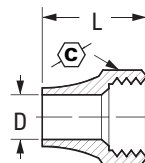
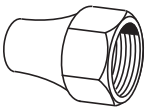

TUBE O.D.	CATALOG NUMBER	C	D	L
3/16	1611x3	7/16	.193	.62
1/4	1611x4	9/16	.260	.75
3/8	1611x6	11/16	.380	.88

Bulkhead Nut

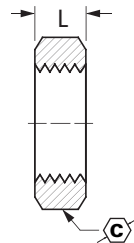
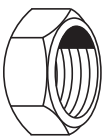

TUBE O.D.	CATALOG NUMBER	C	L
1/4	0102x4	9/16	.25
5/16	0102x5	5/8	.25
3/8	0102x6	11/16	.25
1/2	0102x8	15/16	.38

Use on 741x Bulkhead Unions. Ref. page 51.

Brass Products

Selfalign

Union

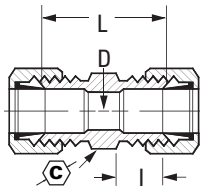
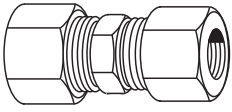

Assembly with long nut 1621x.

TUBE O.D.	CATALOG NUMBER		D	I	L
1/8	621x2	5/16	.094	.25	.66
3/16	621x3	3/8	.125	.28	.76
1/4	621x4	7/16	.188	.31	.79
5/16	621x5	1/2	.250	.34	.88
3/8	621x6	9/16	.312	.38	.97
1/2	621x8	11/16	.406	.44	1.10
5/8	621x10	13/16	.500	.50	1.25

Male Connector

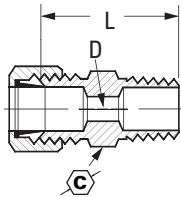
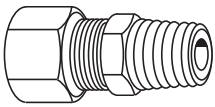

Assembly with long nut 1681x.

TUBE O.D.	MALE PIPE THREAD	CATALOG NUMBER		D	L
1/8	1/16	681x2x1	3/8	.094	.78
1/8	1/8	681x2	7/16	.094	.78
3/16	1/8	681x3	7/16	.125	.84
1/4	1/8	681x4	7/16	.188	.88
1/4	1/4	681x4x4	9/16	.188	1.06
5/16	1/8	681x5	1/2	.234	.91
5/16	1/4	681x5x4	9/16	.250	1.09
3/8	1/8	681x6x2	9/16	.250	.97
3/8	1/4	681x6	9/16	.312	1.17
3/8	3/8	681x6x6	11/16	.312	1.16
3/8	1/2	681x6x8	7/8	.312	1.34
1/2	1/4	681x8x4	11/16	.281	1.22
1/2	3/8	681x8	11/16	.406	1.22
1/2	1/2	681x8x8	7/8	.406	1.41
5/8	1/2	681x10	7/8	.500	1.50

Female Connector

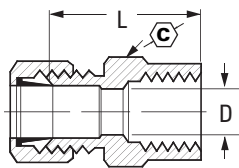
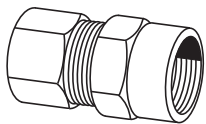

Assembly with long nut 1661x.

TUBE O.D.	FEM. PIPE THREAD	CATALOG NUMBER		D	L
1/8	1/8	661x2	9/16	.094	.75
3/16	1/8	661x3	9/16	.125	.78
1/4	1/8	661x4	9/16	.188	.78
1/4	1/4	661x4x4	11/16	.188	1.03
5/16	1/8	661x5	9/16	.250	.81
3/8	1/8	661x6x2	9/16	.312	.84
3/8	1/4	661x6	11/16	.312	1.06
1/2	3/8	661x8	13/16	.406	1.12

Male Ball Check Connector

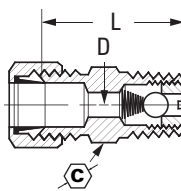
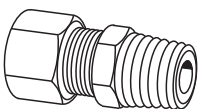

Assembly with long nut 1631x.

Min. pressure 3 psi. Ball and spring position may be reversed to change flow/check direction. Ballcheck valves are neither tested nor adjusted prior to sale.

TUBE O.D.	MALE PIPE THREAD	CATALOG NUMBER		D	L
1/4	1/8	631x4	7/16	.125	.88
3/8	1/4	631x6	9/16	.219	1.16

Brass Products

Selfalign

Bulkhead Union

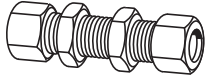

Assembly with long nut 1741x.

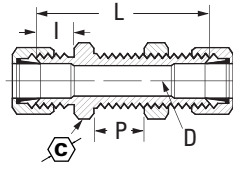

TUBE O.D.	CATALOG NUMBER		D	I	L	MAX. P
1/4	741x4	9/16	.188	.33	1.58	.52

90° Union Elbow

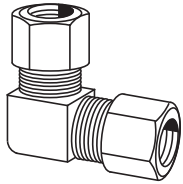

Assembly with long nut 1651x.

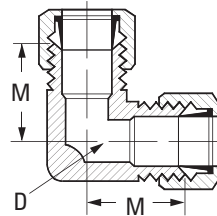

TUBE O.D.	CATALOG NUMBER	D	M
1/4	651x4	.188	.60
3/8	651x6	.312	.73

90° Male Elbow

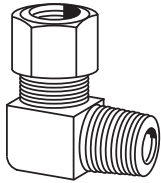

Assembly with long nut 1691x.

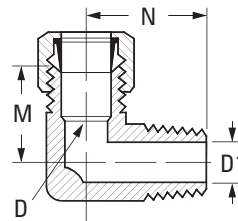

TUBE O.D.	MALE PIPE THREAD	CATALOG NUMBER	D	D1	M	N
1/8	1/16	691x2x1	.109	.125	.54	.66
1/8	1/8	691x2	.094	.219	.60	.67
3/16	1/8	691x3	.125	.188	.62	.69
1/4	1/8	691x4	.188	.219	.62	.75
1/4	1/4	691x4x4	.188	.219	.62	.75
5/16	1/8	691x5	.250	.250	.62	.75
5/16	1/4	691x5x4	.250	.312	.69	.84
3/8	1/8	691x6x2	.312	.234	.69	.69
3/8	1/4	691x6	.312	.344	.75	.94
3/8	3/8	691x6x6	.312	.438	.84	.94
3/8	1/2	691x6x8	.312	.531	1.06	1.12
1/2	1/4	691x8x4	.406	.312	.84	.94
1/2	3/8	691x8	.406	.406	.94	1.12
1/2	1/2	691x8x8	.406	.531	.94	1.31
5/8	1/2	691x10	.500	.562	1.06	1.31

90° Female Elbow

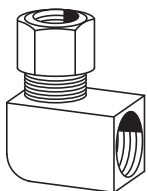

Assembly with long nut 1701x.

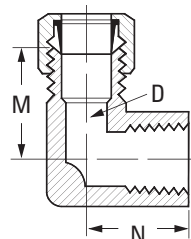

TUBE O.D.	FEM. PIPE THREAD	CATALOG NUMBER	D	M	N
3/16	1/8	701x3	.125	.69	.56
1/4	1/8	701x4	.188	.69	.56

Brass Products

Selfalign

Union Tee

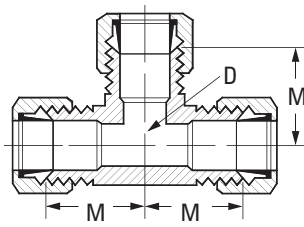
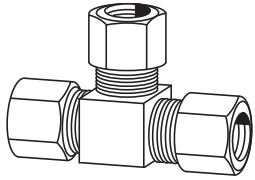

Assembly with long nut 1641x.

TUBE O.D.	CATALOG NUMBER	D	M
3/16	641x3	.125	.60
1/4	641x4	.188	.62
5/16	641x5	.250	.60
3/8	641x6	.312	.73
1/2	641x8	.406	.94

Male Run Tee

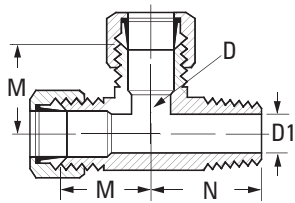
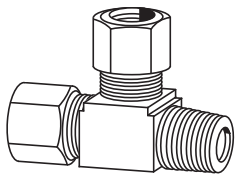

Assembly with long nut 1711x.

TUBE O.D.	MALE PIPE THREAD	CATALOG NUMBER	D	D1 OPT.	M	N
3/16	1/8	711x3	.125	.219	.62	.69
1/4	1/8	711x4	.188	.219	.62	.75
3/8	1/4	711x6	.312	.344	.75	.94

Male Branch Tee

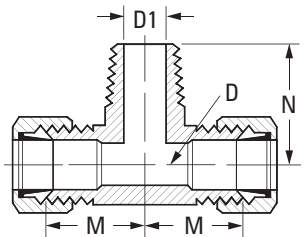
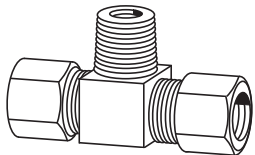

Assembly with long nut 1721x.

TUBE O.D.	MALE PIPE THREAD	CATALOG NUMBER	D	D1	M	N
1/4	1/8	721x4	.188	.219	.62	.75
1/4	1/4	721x4x4x4	.188	.281	.78	.85
3/8	1/4	721x6	.312	.344	.75	.94
1/2	3/8	721x8	.406	.406	.94	1.12

Brass Products

Polyline Flareless

 Refer to safety information regarding proper selection of tubing and tube connectors on page 1.

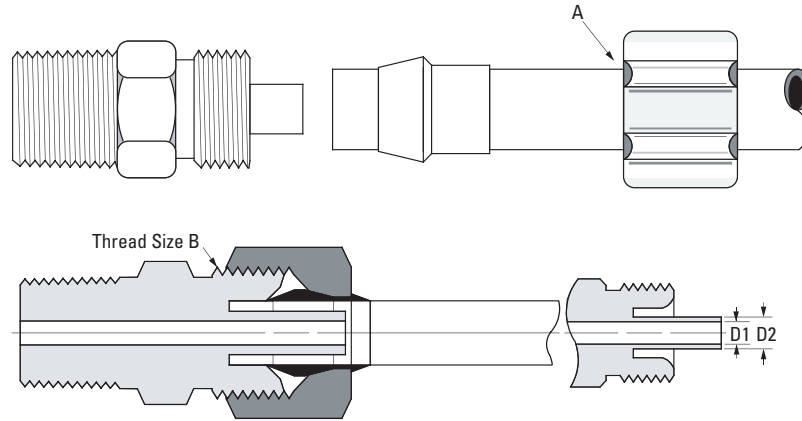

Size	x46	x4	x5	x6	x8
Tube O.D.	1/4	1/4	5/16	3/8	1/2
Thread Size-B	3/8-24	3/8-24	7/16-24	1/2-24	11/16-20
Flow Dia. (D1)	.078	.125	.141	.203	.312
Support Dia. (D2)	.120	.166	.180	.245	.370

Typical Application:

Pneumatic instrumentation circuits, lubricant and cooling lines.

Pressure:

Working pressure up to 500 psi with a 4:1 safety factor depending on tubing. When using plastic tubing, use the working pressure for type used.

Vibration:

Excellent resistance.

Temperature Range:

When using compatible plastic tubing do not exceed the tubing temperature range. (Refer to tubing temperature range.)

Material:

CA360 Brass body, plastic sleeve.

Note:

Not recommended for use with PT230 or TP160 tubing.

Used With:

PT200 and PT240 plastic tubing. Not recommended for metal tubing. See pages 22-26 for material compatibility and pages 27-29 for plastic tubing.

Advantages:

No flaring of tubing required. Easy installation, captive sleeve, pre-assembled for installation and can be reassembled.

Conformance:

An exclusive product design. User approvals only.

How to Order:

Order 1/4" O.D. tubing with .040 wall, use suffix x4. Example: 1262x4. When .062 wall is desired, use suffix x46. Example: 1262x46.

Ordered as complete assemblies (body, nuts and sleeves) by catalog number. Nuts, sleeves and nut/sleeve assemblies can be ordered separately by catalog number.

Note:

Refer to current price list for availability of cataloged items. Quotations and delivery of non-stock items supplied on request. Configurations and dimensions subject to change without notice.

Assembly Instructions:

1. Cut tubing to desired length.
2. Slide nut/sleeve assembly on tube. Threaded end "A" of nut must face toward connector.
3. Bottom tubing into the connector.
4. Tighten nut, hand tight.

Label Set:

FS-2100 (adhesive)
CL-498 (non-adhesive)

Questions:

For additional technical questions, contact Technical Support at 1-888-258-0222.

Brass Products

Polyline Flareless

Plastic Sleeve

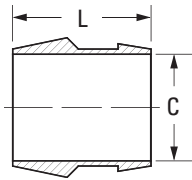
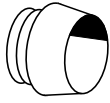

TUBE O.D.	CATALOG NUMBER	C	L
1/4	1260x4	.259	.34
5/16	1260x5	.321	.39
3/8	1260x6	.384	.41
1/2	1260x8	.509	.44

Brass Nut

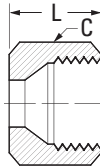

1/8" and 3/16" Nuts are flat Hex type.

TUBE O.D.	CATALOG NUMBER	DIA. C	L
1/4	1261x4	7/16	.34
5/16	1261x5♦	1/2	.34
3/8	1261x6	9/16	.38
1/2	1261x8♦	13/16	.44

♦MTO - Made To Order

Brass Nut/Plastic Sleeve Assembly

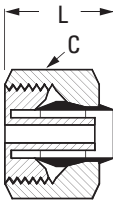
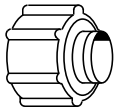

TUBE O.D.	CATALOG NUMBER	DIA. C	L
1/4	1261x4A	7/16	.43
5/16	1261x5A♦	1/2	.45
3/8	1261x6A	9/16	.49
1/2	1261x8A♦	13/16	.46

♦MTO - Made To Order

Brass Bulkhead Nut

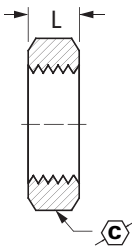



For use with 1274x Bulkhead Unions, ref. page 55.

TUBE O.D.	CATALOG NUMBER		L
1/4	1202x4♦	9/16	.19
3/8	1202x6♦	11/16	.19
1/2	1202x8♦	7/8	.19

♦MTO - Made To Order

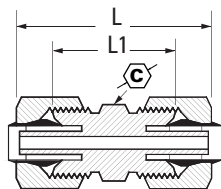
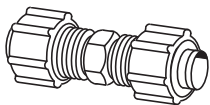
Union



TUBE O.D.	CATALOG NUMBER		L	L1
1/4	1262x4	3/8	1.00	.69
3/8	1262x6	1/2	1.03	.72
1/2	1262x8♦	11/16	1.28	.84

♦MTO - Made To Order

Brass Products

Polyline Flareless

Male Connector

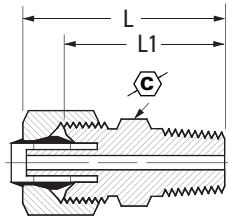
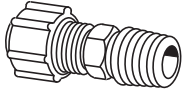

TUBE O.D.	MALE PIPE THREAD	CATALOG NUMBER		L	L1
1/4	1/16	1268x4x1	7/16	.97	.81
1/4	1/8	1268x4	7/16	.97	.81
1/4	1/4	1268x4x4	9/16	1.15	1.00
1/4	3/8	1268x4x6♦	11/16	1.18	1.03
5/16	1/8	1268x5♦	7/16	.97	.81
5/16	1/4	1268x5x4♦	9/16	1.16	1.00
3/8	1/8	1268x6x2	1/2	1.00	.84
3/8	1/4	1268x6	9/16	1.19	1.03
3/8	3/8	1268x6x6	11/16	1.19	1.03
1/2	1/4	1268x8x4♦	11/16	1.31	1.09
1/2	3/8	1268x8	11/16	1.31	1.09
1/2	1/2	1268x8x8♦	11/16	1.62	1.03

♦MTO - Made To Order

Female Connector

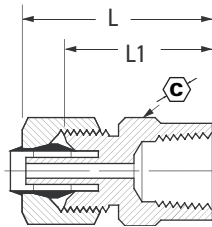
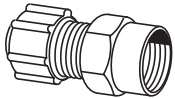

TUBE O.D.	FEM. PIPE THREAD	CATALOG NUMBER		L	L1
1/4	1/8	1266x4	1/2	.87	.72
1/4	1/4	1266x4x4	5/8	1.09	.93
3/8	1/4	1266x6	5/8	1.09	.94

Bulkhead Union

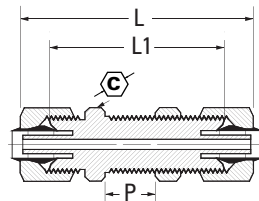
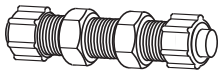

TUBE O.D.	CATALOG NUMBER		L	L1	MAX. P
1/4	1274x4♦	9/16	1.56	1.25	.38
3/8	1274x6♦	11/16	1.68	1.38	.47
1/2	1274x8♦	7/8	2.09	1.66	.63

♦MTO - Made To Order

For Bulkhead Nuts, ref. page 54.

Brass Products

Polyline Flareless

Male Elbow

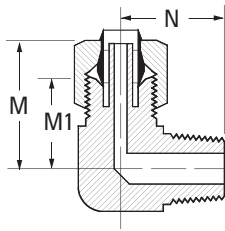
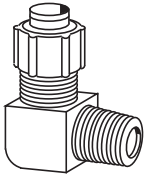

TUBE O.D.	MALE PIPE THREAD	CATALOG NUMBER	M	M1	N
1/4	1/16	1269x4x1	.75	.59	.72
1/4	1/8	1269x4	.75	.59	.72
1/4	1/4	1269x4x4	.81	.66	.94
1/4	3/8	1269x4x6	.84	.69	1.08
5/16	1/8	1269x5♦	.75	.59	.72
3/8	1/8	1269x6x2	.88	.66	.75
3/8	1/4	1269x6	.87	.72	1.00
3/8	3/8	1269x6x6	.87	.72	1.08

♦MTO - Made To Order

Female Elbow

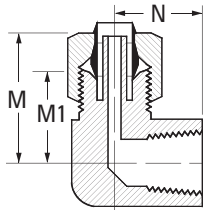
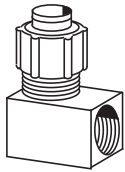

TUBE O.D.	FEM. PIPE THREAD	CATALOG NUMBER	M	M1	N
1/4	1/8	1270x4	.87	.66	.56
1/4	1/4	1270x4x4	.96	.75	.69
3/8	1/4	1270x6♦	.86	.75	.69

♦MTO - Made To Order

Union Tee

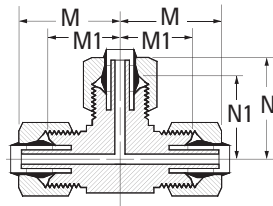
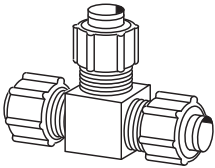

TUBE O.D.	CATALOG NUMBER	M	M1	N	N1
1/4	1264x4	.75	.59	.75	.59
3/8	1264x6	.87	.72	.87	.72

Male Run Tee

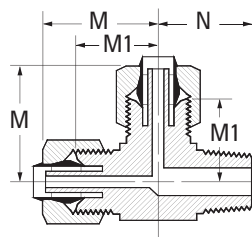
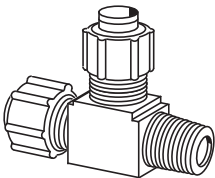

TUBE O.D.	MALE PIPE THREAD	CATALOG NUMBER	M	M1	N
1/4	1/8	1271x4	.75	.59	.72
1/4	1/4	1271x4x4x4♦	.81	.66	.94
3/8	1/4	1271x6♦	.87	.72	1.00

♦MTO - Made To Order

Male Branch Tee

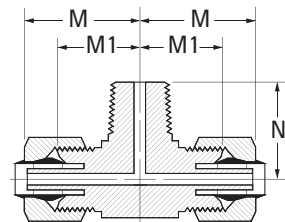
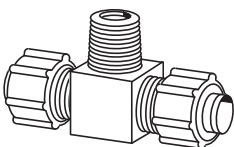

TUBE O.D.	MALE PIPE THREAD	CATALOG NUMBER	M	M1	N
1/4	1/8	1272x4♦	.75	.59	.72
1/4	1/4	1272x4x4x4♦	.81	.66	.94
3/8	1/4	1272x6♦	.87	.72	1.00
1/2	3/8	1272x8♦	1.06	.84	1.12

♦MTO - Made To Order

Brass Products

Push>Connect

Note:
For additional technical questions, contact Technical Support at 1-888-258-0222.

 Refer to safety information regarding proper selection of tubing and tube connectors on page 1.

Push>Connect

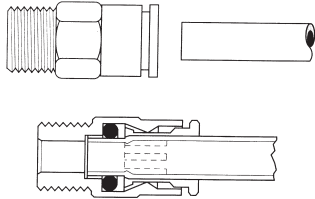

See Push>Connect Products on pages 59-63.

Typical Application:
Compressed air, pneumatic instrumentation, circuit, lubricant and cooling lines.

Pressure:
Up to 250 psi depending on tube size.

Sealing Method:
O-Ring of Buna-N Construction.

Temperature Range:
When using compatible plastic tubing do not exceed the tubing temperature range (Refer to tubing temperature range).

Material:
Brass, Nickel Plated.

Vacuum:
Fittings rated at 29.5 inches of mercury vacuum.

Used With:
PT230 and TP160 nylon, and PT240 Polyethylene tubing. See pages 22-26 for material compatibility and pages 27-29 for plastic tubing.

Advantages:
Ease of assembly. No tools required, reusability of connectors and the time savings of assembly and disassembly.

Hex Dimensions:
All hexes are in inches.

How to Order:
Individually by catalog number.

Note:
Refer to current price list for availability of cataloged items. Quotations and delivery of non-stock items supplied on request. Configurations and dimensions subject to change without notice.

Assembly Instructions:
1. To connect, simply push the tubing into the connector.

2. To disconnect, depress the collet ring with two fingers and withdraw.

Label Set:
CL-499 (non-adhesive)

Push>Connect Metric

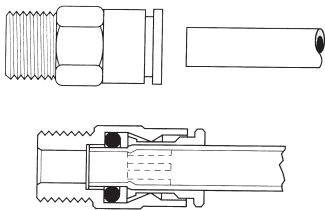

See Push>Connect Products on pages 64-67.

NOMINAL SIZE	2	4	5MM	6	8
Thread					
MM			M5 x .8		
BSPT	1/8 (2PT)	1/4 (4PT)		3/8 (6PT)	1/2 (8PT)
BSPP	1/8 (2PP)	1/4 (4PP)		3/8 (6PP)	1/2

Typical Application:
Compressed air, pneumatic instrumentation, circuit, lubricant and cooling lines.

Pressure:
Up to 250 psi depending on tube size.

Sealing Method:
O-Ring of Buna-N Construction.

Temperature Range:
-40°F to 200°F
(-40°C to 93°C).

Material:
Brass, Nickel Plated.

Used With:
MTP160 nylon tubing. See pages 22-26 for material compatibility and pages 27-29 for plastic tubing.

Advantages:
Ease of assembly. No tools required, reusability of fittings and the time savings of assembly and disassembly.

Hex Dimensions:
All hexes are metric.

How to Order:
Individually by catalog number.

Note:
Refer to current price list for availability of cataloged items. Quotations and delivery of non-stock items supplied on request. Configurations and dimensions subject to change without notice.

Assembly Instructions:
1. To connect, simply push the tubing into the connector.

2. To disconnect, depress the collet ring with two fingers and withdraw.

Suffix Chart:

- MM** - Metric Screw Thread
- MMS** - Metric Screw Thread Swivel
- MRP** - Metric Red Plug
- PP** - British Parallel Plug
- PPS** - British Parallel Pipe Swivel
- PT** - British Tapered Pipe
- PTS** - British Tapered Pipe Swivel

Brass Products

Push>Connect

Note:

For additional technical questions, contact Technical Support at 1-888-258-0222.



Refer to safety information regarding proper selection of tubing and tube connectors on page 1.

Push>Connect Flow Controls

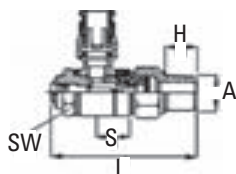
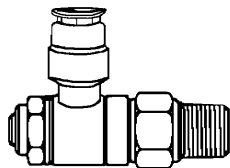

See Push>Connect Products on pages 68-69.

Typical Application:

Compressed air, pneumatic instrumentation, circuit, lubricant and cooling lines. Also excellent for assembly equipment and cylinder control.

Pressure:

Up to 250 psi depending on tube size.

Sealing Method:

O-Ring of Buna-N Construction. (Viton available on request by special order.)

Temperature Range:

0°F to +160°F
(-17.8°C to +71°C)

Material:

Brass, Nickel Plated.

Used With:

PT230 and TP160 nylon, and PT240 Polyethylene tubing. See pages 22-26 for material compatibility and pages 27-29 for plastic tubing.

Advantages:

Ease of assembly. No tools required, reusability of connectors and the time savings of assembly and disassembly. These flow controls have a simple design, but offer excellent ability to control the speed of a cylinder or motor.

Hex Dimensions:

All hexes are in inches.

How to Order:

Individually by catalog number.

Note:

Refer to current price list for availability of cataloged items. Quotations and delivery of non-stock items supplied on request. Configurations and dimensions subject to change without notice.

Assembly Instructions:

1. To connect, simply push the tubing into the connector.
2. To disconnect, depress the collet ring with two fingers and withdraw.

Brass Products

Push>Connect

Cartridge

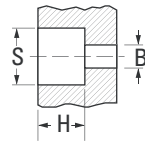

Cartridge body is not Nickel-plated.

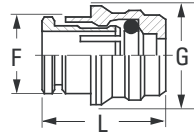

TUBE O.D.	CATALOG NUMBER	F	G	L	S	H	B
1/8	1161x2	.34	.35	.59	.344	.433	.14
5/32	1161x2.5	.34	.35	.57	.344	.433	.14
1/4	1161x4	.46	.48	.65	.470	.472	.16
5/16	1161x5	.54	.56	.67	.549	.551	.25
3/8	1161x6	.62	.64	.79	.627	.590	.32
1/2	1161x8	.74	.76	.83	.746	.629	.42

Plug

(Plastic)

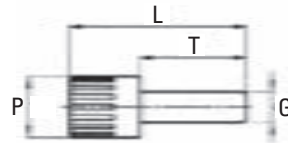

GTUBE O.D.	CATALOG NUMBER	L	P	T
1/8	1129x2	1.04	.24	.65
5/32	1129x2.5	1.04	.24	.65
1/4	1129x4	1.10	.32	.71
5/16	1129x5	1.20	.39	.81
3/8	1129x6	1.38	.47	.91
1/2	1129x8	1.42	.55	.94

Double Union

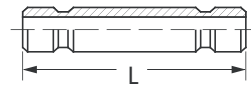

Joins Push>Connect Fittings.

TUBE O.D.	CATALOG NUMBER	L
1/8	1105x2	1.28
5/32	1105x2.5	1.28
1/4	1105x4	1.40
5/16	1105x5	1.59
3/8	1105x6	1.81
1/2	1105x8	1.89

Reducer

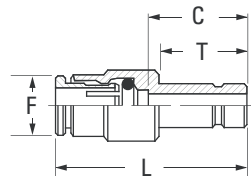

TUBE O.D. A	TUBE O.D. B	CATALOG NUMBER	C	F	L	T
1/8	1/4	1109x2x4	.79	.39	1.38	.71
5/32	1/4	1109x2.5x4	.79	.39	1.34	.71
1/4	3/8	1109x4x6	.86	.51	1.50	.91
1/4	1/2	1109x4x8	.86	.51	1.50	.91
3/8	1/2	1109x6x8	1.00	.67	1.80	.94

Brass Products

Push>Connect

Stem Adapter

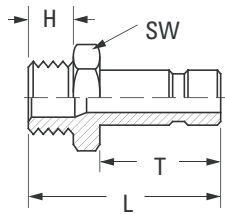

TUBE O.D.	MALE PIPE	CATALOG NUMBER THREAD	H	T	L	SW (MM)
1/8	1/8	1180x2	.37	.65	1.20	12
1/8	1/4	1180x2x4	.51	.65	1.36	14
5/32	1/8	1180x2.5	.37	.65	1.20	12
5/32	1/4	1180x2.5x4	.51	.65	1.36	14
1/4	1/8	1180x4	.37	.71	1.26	12
1/4	1/4	1180x4x4	.51	.71	1.42	14
5/16	1/8	1180x5	.37	.81	1.36	12
5/16	1/4	1180x5x4	.51	.81	1.34	14
3/8	1/4	1180x6	.51	.91	1.61	17
3/8	3/8	1180x6x6	.51	.91	1.61	19
1/2	3/8	1180x8	.51	.94	1.65	19
1/2	1/2	1180x8x8	.71	.94	1.87	22

Union

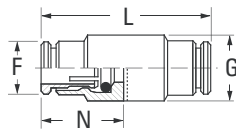

Joins tubing.

TUBE O.D.	CATALOG NUMBER	F	G	L	N
1/8	1162x2	.35	.39	1.26	.59
5/32	1162x2.5	.35	.39	1.18	.55
1/4	1162x4	.46	.47	1.40	.64
5/16	1162x5	.54	.55	1.23	.69
3/8	1162x6	.64	.67	1.67	.79
1/2	1162x8	.72	.75	1.75	.83

Bulkhead Union

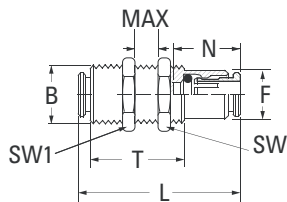

TUBE O.D.	CATALOG NUMBER	B	F	L	N	MAX (MM)	SW (MM)	SW1	T
1/8	1174x2	M10x1	.35	1.26	.59	.35	14	14	.83
5/32	1174x2.5	M10x1	.35	1.18	.55	.32	14	14	.79
1/4	1174x4	M14x1	.49	1.40	.64	.37	17	17	.83
5/16	1174x5	M16x1	.54	1.50	.69	.41	19	19	.83
3/8	1174x6	M18x1	.64	1.67	.77	.47	22	22	.93
1/2	1174x8	M20x1	.72	1.75	.83	.53	24	24	.98

Union "Y"

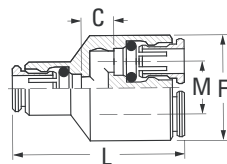

TUBE O.D.	CATALOG NUMBER	C	F	L	M
1/8	1107x2	.24	.83	1.42	.39
5/32	1107x2.5	.24	.83	1.34	.39
1/4	1107x4	.24	.96	1.52	.49

Brass Products

Push>Connect

Swivel Male "Y"



Swivel for installation purposes only.

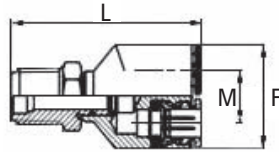

TUBE O.D.	MALE PIPE THREAD	CATALOG NUMBER	F	M	L
1/8	10-32*	1108x2A	.83	.39	1.12
1/8	1/8	1108x2	.83	.39	1.32
5/32	1/8	1108x2.5	.83	.39	1.29
1/4	1/8	1108x4	.96	.49	1.40

*UNF Thread. Seals with nylon washer (included).

Male Connector



Allen wrench use permits close quarter installation not possible with a standard wrench.

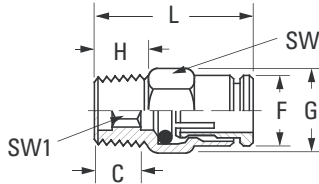

TUBE O.D.	MALE PIPE THREAD	CATALOG NUMBER	C	F	G	H	L	SW (MM)	SW1 (MM)
1/8	10-32*	1168x2A	.26	.35	.41	.18	.85	9	2
1/8	1/8	1168x2	.26	.35	.55	.37	.85	12	2
1/8	1/4	1168x2x4	.39	.35	.63	.51	.98	14	2
5/32	10-32*	1168x2.5A	.26	.35	.41	.18	.81	9	2
5/32	1/8	1168x2.5	.26	.35	.55	.37	.81	12	2.5
5/32	1/4	1168x2.5x4	.39	.35	.63	.51	.94	14	2.5
1/4	10-32*	1168x4A	.27	.46	.55	.18	.91	12	2
1/4	1/8	1168x4	.35	.46	.55	.37	.98	12	4
1/4	1/4	1168x4x4	.44	.46	.63	.51	1.08	14	4
1/4	3/8	1168x4x6	.46	.46	.87	.51	1.10	19	4
5/16	1/8	1168x5	.45	.54	.63	.37	1.14	14	5
5/16	1/4	1168x5x4	.45	.54	.63	.51	1.14	14	6
5/16	3/8	1168x5x6	.45	.54	.87	.51	1.14	19	6
3/8	1/8	1168x6x2	.59	.64	.78	.51	1.38	17	7
3/8	1/4	1168x6	.59	.64	.78	.51	1.38	17	7
3/8	3/8	1168x6x6	.39	.64	.87	.51	1.18	19	7
3/8	1/2	1168x6x8	.47	.64	1.00	.71	1.26	22	7
1/2	3/8	1168x8	.53	.72	.87	.51	1.36	19	10
1/2	1/2	1168x8x8	.53	.72	1.00	.71	1.36	22	10

*UNF Thread. Seals with nylon washer (included).

Female Connector

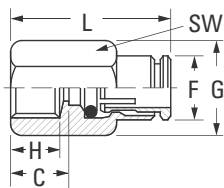

TUBE O.D.	FEM. PIPE	CATALOG NUMBER	C	F	G	H	L	SW (MM)
1/8	1/8	1166x2	.41	.35	.64	.34	1.00	14
1/8	1/4	1166x2x4	.55	.35	.78	.47	1.14	17
5/32	1/8	1166x2.5	.41	.35	.64	.34	.96	14
5/32	1/4	1166x2.5x4	.55	.35	.78	.47	1.10	17
1/4	1/8	1166x4	.43	.46	.64	.34	1.06	14
1/4	1/4	1166x4x4	.56	.46	.78	.47	1.20	17
3/8	1/4	1166x6	.57	.64	.78	.47	1.36	17
3/8	3/8	1166x6x6	.59	.64	1.00	.49	1.38	22

Union Elbow

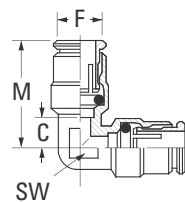

TUBE O.D.	CATALOG NUMBER	C	F	M	SW (MM)
1/8	1165x2	.24	.39	.83	9
5/32	1165x2.5	.24	.39	.79	9
1/4	1165x4	.27	.50	.91	10
5/16	1165x5	.30	.59	.98	12
3/8	1165x6	.34	.69	1.12	14
1/2	1165x8	.39	.77	1.22	17

Brass Products

Push>Connect

Swivel Male Elbow

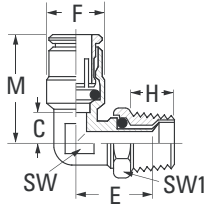

Swivel for installation purposes only.

TUBE O.D.	MALE PIPE THREAD	CATALOG NUMBER	C	E	F	H	M	SW (MM)	SW1 (MM)
1/8	10-32*	1169x2AS	.24	.53	.39	.18	.83	9	8
1/8	1/8	1169x2S	.24	.71	.39	.37	.83	9	12
1/8	1/4	1169x2x4S	.24	.87	.39	.51	.83	9	14
5/32	10-32*	1169x2.5AS	.24	.53	.39	.18	.79	9	8
5/32	1/8	1169x2.5S	.24	.71	.39	.37	.79	9	12
5/32	1/4	1169x2.5x4S	.24	.87	.39	.51	.83	9	14
1/4	1/8	1169x4S	.27	.73	.50	.37	.91	10	12
1/4	1/4	1169x4x4S	.27	.81	.50	.51	.91	10	14
1/4	3/8	1169x4x6S	.29	.87	.50	.51	.93	12	19
5/16	1/8	1169x5S	.30	.77	.59	.37	.98	12	12
5/16	1/4	1169x5x4S	.30	.85	.59	.51	.98	12	14
5/16	3/8	1169x5x6S	.30	.87	.59	.51	.98	12	19
3/8	1/8	1169x6x2S	.34	.75	.64	.20	1.10	14	14
3/8	1/4	1169x6S	.34	.89	.69	.51	1.12	14	14
3/8	3/8	1169x6x6S	.34	.91	.69	.51	1.12	14	19
3/8	1/2	1169x6x8S	.34	1.04	.69	.71	1.12	14	22
1/2	1/4	1169x8x4S	.39	.95	.77	.51	1.22	17	14
1/2	3/8	1169x8S	.39	.95	.77	.51	1.22	17	19
1/2	1/2	1169x8x8S	.39	1.12	.77	.71	1.22	17	22

*UNF Thread. Seals with nylon washer (included).

Male Elbow

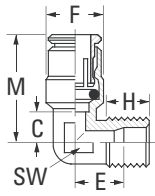

TUBE O.D.	MALE PIPE THREAD	CATALOG NUMBER	C	E	F	H	M	SW (MM)
1/4	1/8	1169x4	.27	.53	.50	.38	.91	10
1/4	1/4	1169x4x4	.27	.59	.50	.51	.91	10
3/8	1/4	1169x6	.34	.69	.69	.51	1.12	14
3/8	3/8	1169x6x6	.34	.69	.69	.51	1.12	14

Union Tee

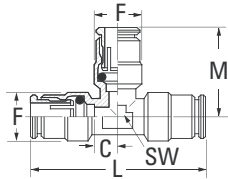

TUBE O.D.	CATALOG NUMBER	C	F	L	M	SW (MM)
1/8	1164x2	.24	.39	1.65	.83	9
5/32	1164x2.5	.24	.39	1.57	.79	9
1/4	1164x4	.27	.50	1.81	.91	10
5/16	1164x5	.30	.59	1.97	.98	12
3/8	1164x6	.34	.69	2.24	1.12	14
1/2	1164x8	.39	.77	2.44	1.22	19

Male Run Tee Swivel

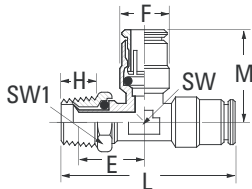

Swivel for installation purposes only.

TUBE O.D.	MALE PIPE THREAD	CATALOG NUMBER	E	F	H	L	M	SW (MM)	SW1 (MM)
1/8	10-32*	1171x2AS	.53	.39	.18	1.53	.83	9	8
1/8	1/8	1171x2S	.59	.35	.20	1.59	.80	9	12
5/32	10-32*	1171x2.5AS	.53	.39	.18	1.50	.79	9	8
5/32	1/8	1171x2.5S	.59	.35	.20	1.57	.79	9	12
5/32	1/4	1171x2.5x4S	.63	.35	.26	1.67	.79	9	14
1/4	1/8	1171x4S	.61	.46	.20	1.69	.89	10	12
1/4	1/4	1171x4x4S	.65	.46	.26	1.79	.89	10	14
1/4	3/8	1171x4x6S	.65	.46	.29	1.83	.89	12	19
3/8	1/4	1171x6S	.77	.64	.26	2.17	1.10	14	14
3/8	3/8	1171x6x6S	.77	.64	.29	2.26	1.10	14	19
3/8	1/2	1171x6x8S	.79	.64	.34	2.22	1.10	14	22
1/2	1/4	1171x8x4S	.81	.72	.26	2.26	1.20	17	13
1/2	3/8	1171x8S	.81	.72	.29	2.30	1.20	17	19
1/2	1/2	1171x8x8S	.83	.72	.34	2.36	1.20	17	22

*UNF Thread. Seals with nylon washer (included).

Brass Products

Push>Connect

Male Branch Tee Swivel



Swivel for installation purposes only.

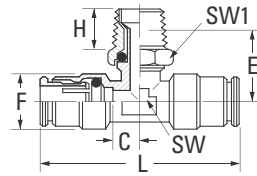

TUBE O.D.	MALE PIPE THREAD	CATALOG NUMBER	C	E	F	H	L	SW (MM)	SW1 (MM)
1/8	10-32*	1172x2AS	.24	.53	.39	.18	1.61	.35	.32
1/8	1/8	1172x2S	.24	.59	.35	.20	1.57	.35	.47
5/32	10-32*	1172x2.5AS	.24	.53	.39	.18	1.57	.35	.32
5/32	1/8	1172x2.5S	.24	.59	.35	.20	1.57	.35	.47
5/32	1/4	1172x2.5x4S	.24	.63	.35	.26	1.57	.35	.55
1/4	1/8	1172x4S	.28	.60	.46	.20	1.77	.39	.47
1/4	1/4	1172x4x4S	.28	.65	.46	.26	1.77	.39	.55
1/4	3/8	1172x4x6S	.28	.65	.46	.29	1.77	.47	.75
3/8	1/4	1172x6S	.34	.77	.64	.26	2.20	.55	.55
3/8	3/8	1172x6x6S	.34	.77	.64	.29	2.20	.55	.75
3/8	1/2	1172x6x8S	.34	.79	.64	.34	2.20	.55	.87
1/2	1/4	1172x8x4S	.39	.80	.72	.26	2.40	.67	.55
1/2	3/8	1172x8S	.39	.80	.72	.29	2.40	.67	.75
1/2	1/2	1172x8x8S	.39	.83	.72	.34	2.40	.67	.87

*UNF Thread. Seals with nylon washer (included).

Stud Manifolds

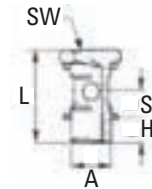

MALE PIPE THREAD A	CATALOG NUMBER	H	L	S (MM)	SW (MM)
10-32*	1184x1xA	.16	.71	.18	.32
1/8	1184x1x2	.24	1.06	.34	.55
3/8	1184x1x6	.35	1.18	.34	.75

*UNF Thread. Seals with nylon washer (included).

Stud Manifolds

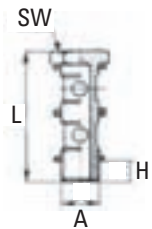

MALE PIPE THREAD A	CATALOG NUMBER	H	L	SW (MM)
1/4	1185x2x4	.32	1.79	.67

Banjo

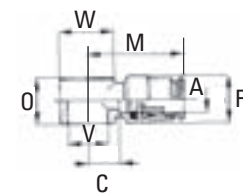

TUBE O.D. A	CATALOG NUMBER	C	F	M	O	V	W
5/32	1181x2.5A	.20	.35	.75	.35	.20	.35
1/8	1181x2x2	.32	.39	.89	.57	.39	.55
1/4	1181x4x2	.35	.50	.98	.57	.39	.55
1/4	1181x4x4	.43	.50	1.06	.57	.52	.71

Female Banjo

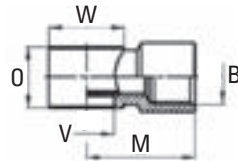

FEMALE PIPE THREAD B	CATALOG NUMBER	V	O	M	W
10-32*	1183xAxA	10-32	.35	.41	.35
1/8	1183x2x2	1/8	.57	.83	.55
1/4	1183x4x4	1/4	.57	1.02	.71
3/8	1183x6x6	3/8	.57	1.12	.83

*UNF Thread. Seals with nylon washer (included).

Brass Products

Push>Connect Metric

Cartridge

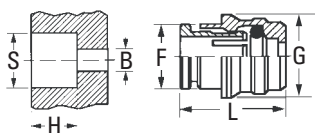

TUBE O.D. (MM)	CATALOG NUMBER	F	G	L	S	H	B
5	1161x5M	9.6	10.0	15.5	9.75	11.5	3.5
6	1161x6M	11.8	12.2	16.5	11.95	12.0	4.0
8	1161x8M	13.8	14.2	18.0	13.95	14.0	6.0

Plug (plastic)

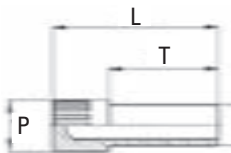

TUBE O.D. (MM)	CATALOG NUMBER	L	P	T
4	1129x4MRP	25.0	8	16.0
5	1129x5MRP	25.5	8	16.5
6	1129x6MRP	26.5	8	17.5
8	1129x8MRP	29.5	12	19.5
10	1129x10MRP	32.0	12	19.5
12	1129x12MRP	35.5	16	23.5

Double Union



Joins Metric Push>Connect fittings.

TUBE O.D. (MM)	CATALOG NUMBER	L
4	1105x4M	32.5
6	1105x6M	35.5
8	1105x8M	40.5
10	1105x10M	46.0

Reducer



A B

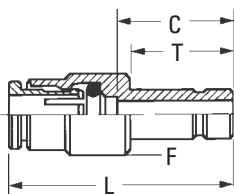

TUBE O.D. A (MM)	TUBE O.D. B (MM)	CATALOG NUMBER	C	F	L	T
4	6	1109x4Mx6M	20.0	10	34.0	18.0
6	8	1109x6Mx8M	22.5	13	38.5	20.5
6	10	1109x6Mx10M	21.0	13	36.5	23.0
8	10	1109x8Mx10M	25.0	14	42.5	23.0
8	12	1109x8Mx12M	22.5	14	40.0	24.0

Stem Adapter

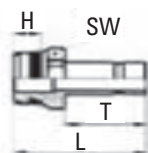

TUBE O.D. (MM)	THD. SIZE BSPP D	CATALOG NUMBER	H	T	L	SW (MM)
4	1/8	1180x4Mx2PP	5.5	16.5	27.8	12
5	1/8	1180x5Mx2PP	5.5	18.0	29.3	12
6	1/8	1180x6Mx2PP	5.5	18.0	29.3	12
6	1/4	1180x6Mx4PP	7.0	18.0	31.0	14
8	1/8	1180x8Mx2PP	5.5	20.5	31.8	12
8	1/4	1180x8Mx4PP	7.0	20.5	33.5	14
10	1/4	1180x10Mx4PP	7.0	23.0	36.0	14
10	3/8	1180x10Mx6PP	8.0	23.0	37.3	19
12	3/8	1180x12Mx6PP	8.0	24.0	38.3	19

Union

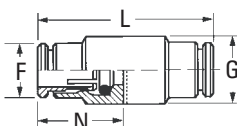

Joins metric tubing.

TUBE O.D. (MM)	CATALOG NUMBER	F	G	L	N
4	1162x4M	8.8	10	30.0	14.0
5	1162x5M	9.8	11	33.0	15.0
6	1162x6M	11.7	12	34.0	15.5
8	1162x8M	13.7	14	38.0	17.5
10	1162x10M	16.3	17	41.5	19.5
12	1162x12M	18.3	19	44.5	21.0

Brass Products

Push>Connect Metric

Bulkhead Union

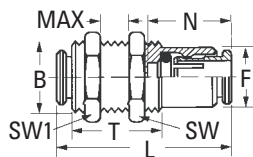

Union "Y"

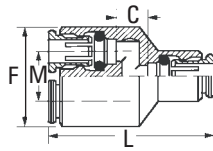

Male "Y"

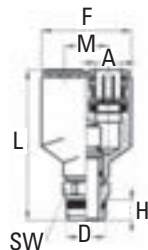

Male Connector (Universal BSPT/BSPP)



Allen wrench use permits close quarter installation not possible with a standard wrench.

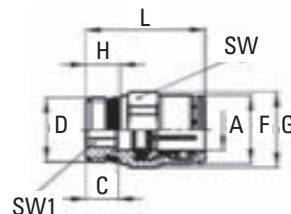

Male Connector



Allen wrench use permits close quarter installation not possible with a standard wrench.

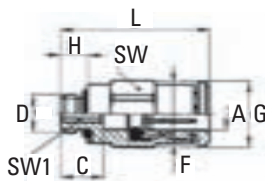

Female Connector (BSPP)

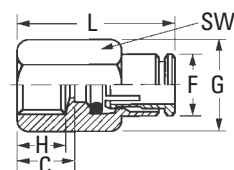

TUBE O.D. (MM)	CATALOG NUMBER	B	F	L	N	MAX	SW (MM)	SW1 (MM)	T
4	1174x4M	M10x1	8.6	30.0	14.0	10.5	14	14	20.0
5	1174x5M	M12x1	9.8	33.0	14.5	10.5	17	17	20.0
6	1174x6M	M14x1	12.5	34.0	15.5	10.5	17	17	20.0
8	1174x8M	M16x1	14.5	38.0	17.5	11.5	19	19	21.0
10	1174x10M	M18x1	16.3	42.5	20.0	13.0	22	22	23.5
12	1174x12M	M20x1	18.3	44.5	21.0	14.5	24	24	25.0

TUBE O.D. (MM)	CATALOG NUMBER	F	C	L	M
4	1107x4M	18.0	6.0	33.0	10.0
6	1107x6M	24.5	7.0	39.0	12.5
8	1107x8M	29.5	9.0	44.0	14.5
10	1107x10M	33.5	15.5	53.5	16.0

TUBE O.D. (MM) A	THREAD SIZE BSP D	CATALOG NUMBER	F	H	M	L	SW (MM)
4	1/8	1108x4Mx2PT	18.0	5.5	10.0	38.0	12
6	1/8	1108x6Mx2PT	24.5	5.5	12.5	41.5	12

*M5x0.8 metric screw thread. Seals with nylon washer (included).

TUBE O.D. (MM) A	THREAD SIZE BSP D	CATALOG NUMBER	C	F	G	H	L	SW (MM)	SW1 (MM)
4	1/8	1168x4Mx2PT	3.8	8.8	13.2	5.5	18.0	12	2.5
4	1/4	1168x4Mx4PT	6.0	8.8	15.2	7.0	19.5	14	2.5
5	1/8	1168x5Mx2PT	3.8	9.8	13.2	5.5	19.0	12	3.0
5	1/4	1168x5Mx4PT	5.5	9.8	15.2	7.0	20.0	14	3.0
6	1/8	1168x6Mx2PT	5.0	11.7	13.2	5.5	20.5	12	4.0
6	1/4	1168x6Mx4PT	5.5	11.7	15.2	7.0	21.0	14	4.0
8	1/8	1168x8Mx2PT	7.5	13.7	15.2	5.5	25.0	14	5.0
8	1/4	1168x8Mx4PT	6.5	13.7	15.2	7.0	24.0	14	6.0
8	3/8	1168x8Mx6PT	6.5	13.7	20.5	8.0	23.5	19	6.0
10	1/4	1168x10Mx4PT	8.5	16.3	18.5	7.0	28.5	17	7.0
10	3/8	1168x10Mx6PT	5.5	16.3	20.5	8.0	25.5	19	8.0
10	1/2	1168x10Mx8PT	5.0	16.3	24.5	9.0	25.0	22	8.0
12	1/4	1168x12Mx4PT	10.5	18.3	20.5	7.0	31.5	19	7.0
12	3/8	1168x12Mx6PT	9.5	18.3	20.5	8.0	30.5	19	9.0
12	1/2	1168x12Mx8PT	6.0	18.3	24.5	9.0	27.0	22	10.0

TUBE O.D. (MM) A	THREAD SIZE	CATALOG NUMBER	C	F	G	H	L	SW (MM)	SW1 (MM)
5	M5*	1168x5Mx5MM	5.5	8.8	9.9	3.5	20.5	9	2
6	M5*	1168x6Mx5MM	5.5	11.7	13.2	3.5	21.5	12	2

*M5x0.8 metric screw thread. Seals with nylon washer (included).

TUBE O.D. (MM) A	THREAD SIZE BSPP	CATALOG NUMBER	C	F	G	H	L	SW (MM)
4	1/8	1166x4Mx2PP	9.5	9.0	15.2	7.5	23.5	14
4	M5*	1166x4Mx5MM	6.5	8.8	9.9	5.0	20.5	9
6	1/8	1166x6Mx2PP	9.5	11.7	15.2	7.5	25.5	14
6	1/4	1166x6Mx4PP	13.0	11.7	18.5	11.0	29.0	17
8	1/8	1166x8Mx2PP	10.0	13.7	15.3	7.5	27.5	14
8	1/4	1166x8Mx4PP	13.5	13.7	18.5	11.0	31.0	17
10	1/4	1166x10Mx4PP	13.5	16.3	18.5	11.0	33.0	17

*M5x0.8 is M profile thread. Seals with nylon washer (included).

Brass Products

Push>Connect Metric

Union Elbow

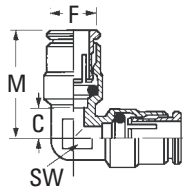

TUBE O.D. (MM)	CATALOG NUMBER	C	F	M	SW (MM)
4	1165x4M	6.0	10.0	20	9
5	1165x5M	6.0	11.0	21	9
6	1165x6M	6.5	13.0	22	10
8	1165x8M	7.5	15.0	25	12
10	1165x10M	8.5	17.5	28	14
12	1165x12M	10.0	19.5	31	16

Male Elbow (Universal BSPT/BSPP)

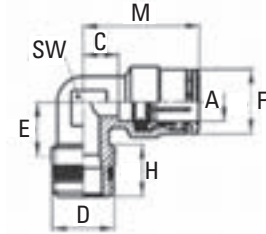

TUBE O.D. (MM)	THREAD SIZE BSP D	CATALOG NUMBER	C	E	F	H	M	SW (MM)
4	1/8	1169x4Mx2PT	6.0	14.5	10.0	7.5	20	9
4	1/4	1169x4Mx4PT	6.0	14.5	10.0	11.0	20	9
5	1/8	1169x5Mx2PT	6.0	14.5	11.0	7.5	21	9
5	1/4	1169x5Mx4PT	6.0	14.5	11.0	11.0	21	9
6	1/8	1169x6Mx2PT	6.5	15.0	12.7	8.5	22	10
6	1/4	1169x6Mx4PT	6.5	15.0	12.7	11.5	22	10
8	1/8	1169x8Mx2PT	7.5	16.0	15.0	8.5	25	12
8	1/4	1169x8Mx4PT	7.5	16.0	15.0	11.0	25	12
8	3/8	1169x8Mx6PT	7.5	16.3	15.0	11.5	25	12
10	1/4	1169x10Mx4PT	7.5	18.5	17.5	11.5	27	14
10	3/8	1169x10Mx6PT	7.5	19.0	17.5	11.5	27	14
12	1/4	1169x12Mx4PT	10.0	20.0	19.5	11.5	31	16
12	3/8	1169x12Mx6PT	10.0	20.0	19.5	11.5	31	16

Male Elbow Swivel (Universal BSPT/BSPP)

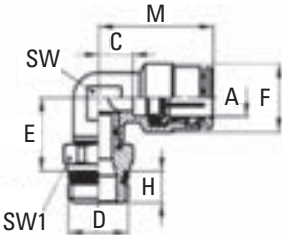

TUBE O.D. (MM)	THREAD SIZE BSP D	CATALOG NUMBER	C	E	F	H	M	SW (MM)	SW1 (MM)
4	1/8	1169x4Mx2PTS	6.0	14.5	10.0	5.5	20.0	9	12
4	1/4	1169x4Mx4PTS	6.0	14.5	10.0	7.0	20.0	9	14
5	1/8	1169x5Mx2PTS	6.0	14.5	11.0	5.5	21.0	9	12
5	1/4	1169x5Mx4PTS	6.0	14.5	11.0	7.0	21.0	9	14
6	1/8	1169x6Mx2PTS	6.5	15.0	12.7	5.5	22.0	10	12
6	1/4	1169x6Mx4PTS	6.5	15.0	12.7	7.0	22.5	10	14
8	1/8	1169x8Mx2PTS	7.5	16.0	15.0	5.5	25.5	12	12
8	1/4	1169x8Mx4PTS	7.5	16.0	15.0	7.0	25.0	12	14
8	3/8	1169x8Mx6PTS	7.5	16.5	15.0	8.0	25.0	12	19
10	1/4	1169x10Mx4PTS	8.5	18.5	17.5	7.0	28.5	14	14
10	3/8	1169x10Mx6PTS	8.5	19.0	17.5	8.0	28.5	14	19
10	1/2	1169x10Mx8PTS	8.5	19.5	17.5	9.0	28.5	14	22
12	1/4	1169x12Mx4PTS	10.0	20.0	19.5	7.0	31.0	16	17
12	3/8	1169x12Mx6PTS	10.0	20.0	19.5	8.0	31.0	16	19
12	1/2	1169x12Mx8PTS	10.0	20.5	19.5	9.0	31.0	16	22

Swivel for installation purposes only.

Male Elbow Swivel



Swivel for installation purposes only.

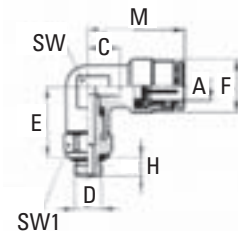

TUBE O.D. (MM)	THREAD SIZE	CATALOG NUMBER	C	E	F	H	M	SW (MM)	SW1 (MM)
4	M5*	1169x4Mx5MMS	6	13	10	3.5	20	9	8
5	M5*	1169x5Mx5MMS	6	13	11	3.5	21	9	8

*M5x0.8 metric screw thread. Seals with nylon washer (included).

Brass Products

Push>Connect Metric

Male Run Tee Swivel (Universal BSPT/BSPP)



Swivel for installation purposes only.

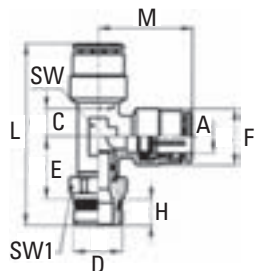

TUBE O.D. (MM)	THD. SIZE BSP D	CATALOG NUMBER	C	E	F	H	L	M	SW (MM)	SW1 (MM)
4	1/8	1171x4Mx2PTS	6.0	14.5	10.0	5.5	40.0	20.0	9	12
5	1/8	1171x5Mx2PTS	6.0	14.5	11.0	5.5	41.0	21.0	9	12
5	1/4	1171x5Mx4PTS	6.0	14.5	11.0	7.0	42.5	21.0	9	14
6	1/8	1171x6Mx2PTS	6.5	15.0	12.7	5.5	42.5	22.5	10	12
6	1/4	1171x6Mx4PTS	6.5	15.0	12.7	7.0	44.0	22.5	10	14
8	3/8	1171x8Mx6PTS	7.5	16.5	15.0	8.0	49.5	25.0	12	19
10	1/4	1171x10Mx4PTS	8.5	18.5	17.5	7.0	54.0	28.5	14	14
10	3/8	1171x10Mx6PTS	8.5	18.5	17.5	8.0	55.5	28.5	14	19
12	3/8	1171x12Mx6PTS	10.0	19.5	19.5	8.0	59.0	31.0	16	19

Union Tee

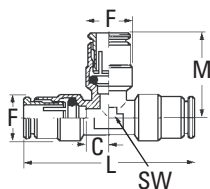

TUBE O.D. (MM)	CATALOG NUMBER	C	F	L	M	SW (MM)
4	1164x4M	6.0	10.0	40	20.0	9
5	1164x5M	6.0	11.0	42	21.0	9
6	1164x6M	6.5	12.7	45	22.5	10
8	1164x8M	7.5	15.0	50	25.0	12
10	1164x10M	8.5	17.5	57	28.5	14
12	1164x12M	10.0	19.5	62	31.0	16

Male Run Tee Swivel



Swivel for installation purposes only.

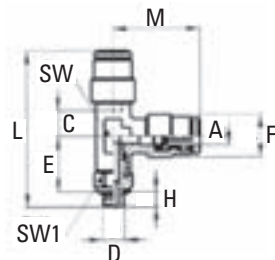

TUBE O.D. (MM)	THD. SIZE BSP D	CATALOG NUMBER	C	E	F	H	L	M	SW (MM)	SW1 (MM)
4	M5*	1171x4Mx5MMS	6	13	10	3.5	36.5	20	9	8
5	M5*	1171x5Mx5MMS	6	13	11	3.5	37.5	21	9	8

*M5x0.8 metric screw thread. Seals with nylon washer (included).

Male Branch Tee Swivel (Universal BSPT/BSPP)



Swivel for installation purposes only.

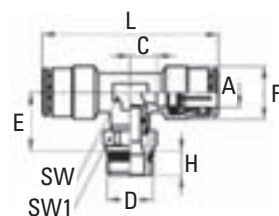

TUBE O.D. (MM)	THREAD SIZE BSP D	CATALOG NUMBER	C	E	F	H	L	M	SW (MM)	SW1 (MM)
4	1/8	1172x4Mx2PTS	6.0	14.5	10.0	5.5	40	9	12	
5	1/8	1172x5Mx2PTS	6.0	14.5	11.0	5.5	42	9	12	
5	1/4	1172x5Mx4PTS	6.0	14.5	11.0	7.0	42	9	14	
6	1/8	1172x6Mx2PTS	6.5	15.0	12.7	5.5	44	10	12	
6	1/4	1172x6Mx4PTS	6.5	15.0	12.7	7.0	44	10	14	
8	1/8	1172x8Mx2PTS	7.5	16.0	15.0	5.5	50	12	12	
8	1/4	1172x8Mx4PTS	7.5	16.0	15.0	7.0	50	12	14	
8	3/8	1172x8Mx6PTS	7.5	16.5	15.0	8.0	50	12	19	
10	1/4	1172x10Mx4PTS	8.5	18.5	17.5	7.0	57	14	14	
10	3/8	1172x10Mx6PTS	8.5	19.0	17.5	8.0	57	14	19	
12	1/4	1172x12Mx4PTS	10.0	20.0	19.5	7.0	62	16	17	
12	3/8	1172x12Mx6PTS	10.0	20.0	19.5	8.0	62	16	19	
12	1/2	1172x12Mx8PTS	10.0	20.5	19.5	9.0	62	16	22	

Male Branch Tee Swivel



Swivel for installation purposes only.

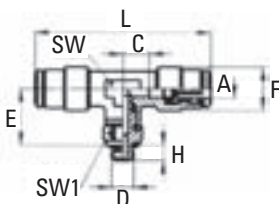

TUBE O.D. (MM)	THREAD SIZE BSP D	CATALOG NUMBER	C	E	F	H	L	M	SW (MM)	SW1 (MM)
4	M5*	1172x4Mx5MMS	6	13	10	3.5	40	9	12	8

*M5x0.8 metric screw thread. Seals with nylon washer (included).

Brass Products

Push>Connect Flow Controls

Right Angle Flow Control and Needle Valves

SCU-MCU

Technical Data

Valve:

Flow Regulator

Regulation:

Adjustable Screw

Material:

Brass; Nickel Plated

Seals:

Buna-N

Note:

For additional technical questions, contact Technical Support at 1-888-258-0222.

Threads:

10-32 UNF - 1/8 - 1/4 - 3/8
NPTF

Tube Sizes:

1/8 - 5/32 - 1/4 - 3/8

Operating Pressures:

to 150 PSI

Nominal Diameter:

10-32 UNF = .059 - 1/8 = .078

1/4 = .157 - 3/8 = .275

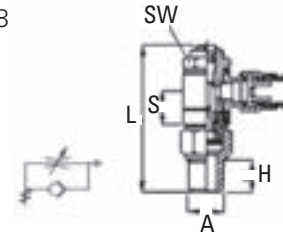
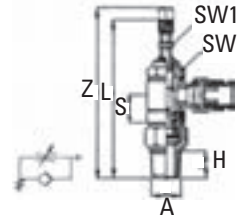

Flow Control Valve Performance

Air flow is determined with 85 PSI at the in port and with 70 PSI at the outlet

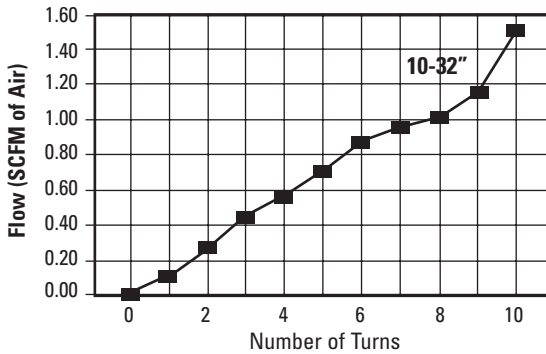

Air flow (SCFM) from B to A
With adjustment open 1.9
With adjustment closed 1.4

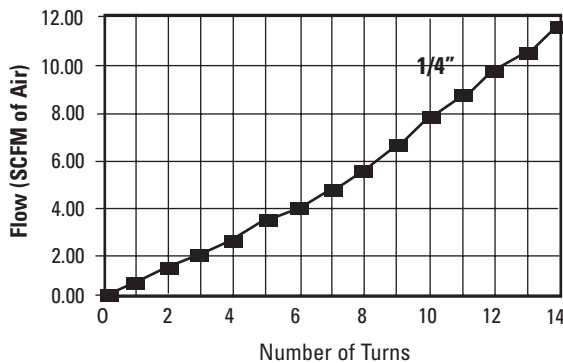
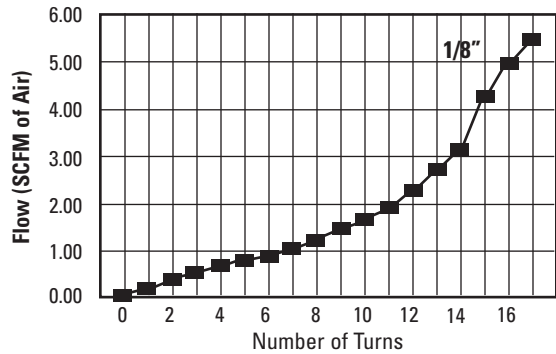

Air flow (SCFM) from B to A
With adjustment open 15
With adjustment closed 8

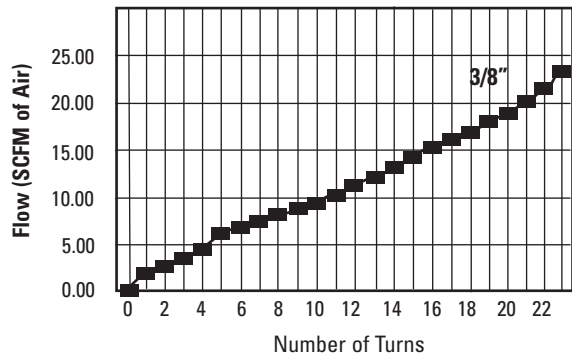

Air flow (SCFM) from B to A
With adjustment open 23
With adjustment closed 13

Brass Products

Push>Connect Flow Controls

Identification of flow control

These unidirectional flow controllers have been designed as small as possible so as to be mounted directly on valves or cylinders.



SCU
MCU

Coding of Banjo flow controllers

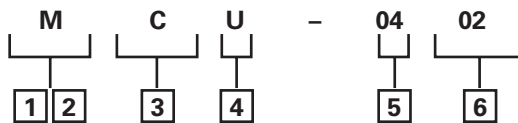

1, 2, Adjustment

M=Manual
S=Screwdriver

3, Assembly

C=On cylinders

4 Function

U= unidirectional
(flow control)

5 Port A

6 Thread B

SCU



Port A

Thread B

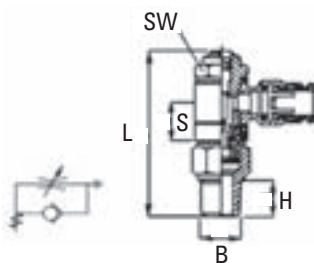

CATALOG NUMBER	TUBE O.D.	B NPTF	S	H	L	SW (MM)
A555SCUx2.5A*	5/32	10-32	.22	.18	1.141	8
A555SCUx2.5x2	5/32	1/8	.51	.37	2.00	14
A555SCUx4x2	1/4	1/8	.51	.37	2.00	14
A555SCUx4x4	1/4	1/4	.45	.51	2.25	17
A555SCUx6x4	3/8	1/4	.45	.51	2.25	17
A555SCUx6x6	3/8	3/8	.48	.51	2.44	19

*UNF Thread

SCU



Port A

Thread B

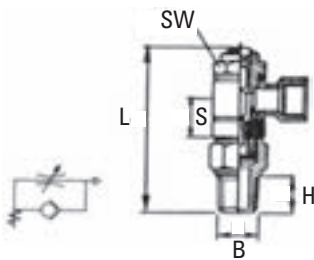

CATALOG NUMBER	BANJO FEMALE THREAD	B NPTF	S	H	L	SW (MM)
A557SCUx2x2	1/8	1/8	.51	.37	2.00	14
A557SCUx4x4	1/4	1/4	.45	.51	2.25	17
A557SCUx6x6	3/8	3/8	.48	.51	2.44	19

MCU



Port A

Thread B

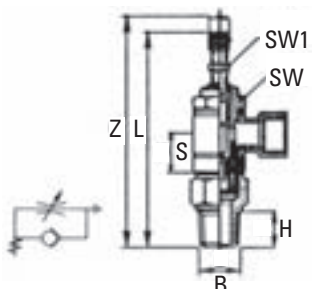

CATALOG NUMBER	BANJO FEMALE THREAD	B NPTF	S	H	L	Z	SW (MM)	SW1 (MM)
A557MCUx2x2	1/8	1/8	.51	.37	2.38	2.56	14	7
A557MCUx6x6	3/8	3/8	.48	.51	2.95	3.25	19	10

Brass Products

Push>Connect Plus

Eaton is proud to announce three design changes to Push>Connect products. The introduction of a low profile, sure-seal design for male NPTF threaded fittings is here. Also, an improved collet design will allow use with all types of tubing from Nylon to 90A durometer Polyurethane, including Polyethylene, and PVC tubing. Lastly, the male swivel design provides greater strength and stability.

Below is a summary of features and benefits for the newly named Push>Connect Plus.

Perfect thread seal:

A captured Teflon® ring around the base of the hex shoulder, seals similar to a reusable (SAE type) seal eliminates thread sealant and loose particles associated with thread sealant.

Lower Profile:

Push>Connect Plus has a lower profile for those tight places. A shorter thread design eliminates exposed threads where dirt and bacteria can collect (ideal for food processing and hygienic applications).

More Versatility:

The new brass collet is designed for use with all types of tubing from Nylon to 90A durometer Polyurethane, including Polyethylene, and PVC tubing.

Note:

For additional technical questions, contact Technical Support at 1-888-258-0222.

Super-quick Installations:

New short thread length means fewer turns and super-quick installations.

Improved Swivel Design:

Strength and stability have been engineered into the new male swivel.

Universal Thread:

Use with NPT, BSPP, and BSPT ports.

The new part will have a 'P' in the part number to signify the new design. An example of this change is previous #1169x4S becomes #1169Px4S. Current Push>Connect parts with 10-32UNF threads and ending in 'A' (eg.1168x2A) will continue with the current thread design.

Swivel Male "Y"

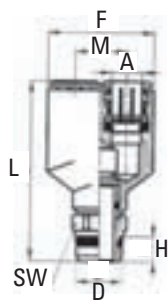

Male Connector

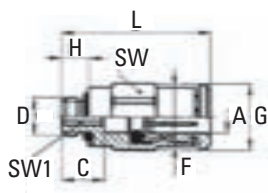

TUBE O.D.	MALE PIPE	CATALOG NUMBER THREAD	F	H	M	L
1/8	1/8	1108Px2S	.83	.20	.39	1.28
5/32	1/8	1108Px2.5S	.83	.20	.39	1.28
1/4	1/8	1108Px4S	.96	.20	.49	1.40

TUBE O.D. A	MALE PIPE THREAD D	CATALOG NUMBER	F	G	H	L	SW (MM)	SW1 (MM)
1/8	10-32*	1168Px2A	.346	.411	.177	.846	9	2.0
1/8	1/8	1168Px2	.346	.551	.200	.728	12	2.5
1/8	1/4	1168Px2x4	.346	.629	.255	.807	14	2.5
5/32	10-32*	1168x2.5A	.346	.411	.177	.807	9	2.0
5/32	1/8	1168Px2.5	.346	.551	.200	.728	12	2.5
5/32	1/4	1168Px2.5x4	.346	.629	.255	.807	14	2.5
1/4	10-32*	1168x4A	.460	.551	.177	.905	12	2.0
1/4	1/8	1168Px4	.460	.551	.200	.807	12	4.0
1/4	1/4	1168Px4x4	.460	.629	.255	.846	14	4.0
1/4	3/8	1168Px4x6	.460	.866	.294	.885	19	4.0
5/16	1/8	1168Px5	.539	.629	.200	.945	14	5.0
5/16	1/4	1168Px5x4	.539	.629	.255	.945	14	6.0
5/16	3/8	1168Px5x6	.539	.866	.294	.924	19	6.0
3/8	1/8	1168Px6x2	.641	.776	.200	1.082	17	5.0
3/8	1/4	1168Px6	.641	.776	.255	1.102	17	7.0
3/8	3/8	1168Px6x6	.641	.866	.294	.945	19	7.0
3/8	1/2	1168Px6x8	.641	1.004	.335	.984	22	7.0
1/2	3/8	1168Px8	.720	.866	.294	1.161	19	10.0
1/2	1/4	1168Px8x4	.720	.866	.255	1.161	19	7.0
1/2	1/2	1168Px8x8	.720	1.004	.335	1.062	22	10.0

*UNF Thread

Brass Products

Push>Connect Plus

Swivel Male Elbow

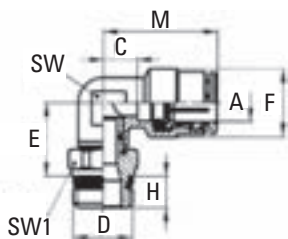

Swivel for installation purposes only.

TUBE O.D.	MALE PIPE THD.	CATALOG NUMBER	C	E	F	H	M	SW (MM)	SW1 (MM)
1/8	1/8	1169Px2S	.24	.59	.35	.20	.81	9	12
1/8	1/4	1169Px2x4S	.24	.63	.35	.26	.81	9	14
5/32	1/8	1169Px2.5S	.24	.59	.35	.20	.79	9	12
5/32	1/4	1169Px2.5x4S	.24	.63	.35	.26	.79	9	14
1/4	1/8	1169Px4S	.27	.63	.46	.20	.89	10	12
1/4	1/4	1169Px4x4S	.27	.65	.46	.26	.89	10	14
1/4	3/8	1169Px4x6S	.27	.65	.46	.29	.89	12	19
5/16	1/8	1169Px5S	.30	.65	.54	.20	.96	12	12
5/16	1/4	1169Px5x4S	.30	.69	.54	.26	.96	12	14
5/16	3/8	1169Px5x6S	.30	.69	.54	.29	.96	12	19
3/8	1/8	1169Px6x2S	.34	.75	.64	.20	1.10	14	14
3/8	1/4	1169Px6S	.34	.77	.64	.26	1.10	14	14
3/8	3/8	1169Px6x6S	.34	.77	.64	.29	1.10	14	19
3/8	1/2	1169Px6x8S	.34	.79	.64	.34	1.10	14	22
1/2	1/4	1169Px8x4S	.39	.81	.72	.26	1.20	17	17
1/2	3/8	1169Px8S	.39	.81	.72	.29	1.20	17	19
1/2	1/2	1169Px8x8S	.39	.83	.72	.36	1.20	17	22

Male Run Tee Swivel

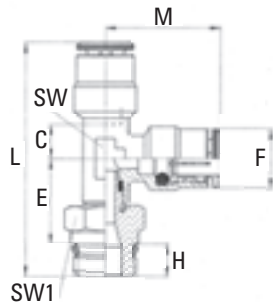

Swivel for installation purposes only.

TUBE O.D.	MALE PIPE THD.	CATALOG NUMBER	C	E	F	H	L	M	SW (MM)	SW1 (MM)
1/8	1/8	1171Px2S	.24	.59	.35	.20	1.59	.81	9	12
5/32	1/8	1171Px2.5S	.24	.59	.35	.20	1.57	.79	9	12
5/32	1/4	1171Px2.5x4S	.24	.63	.35	.26	1.67	.79	9	14
1/4	1/8	1171Px4S	.27	.61	.46	.20	1.69	.89	10	12
1/4	1/4	1171Px4x4S	.27	.65	.46	.26	1.79	.89	10	14
1/4	3/8	1171Px4x6S	.27	.65	.46	.29	1.83	.89	12	19
3/8	1/4	1171Px6S	.34	.77	.64	.26	2.13	1.10	14	14
3/8	3/8	1171Px6x6S	.34	.77	.64	.29	2.17	1.10	14	19
3/8	1/2	1171Px6x8S	.34	.79	.64	.34	2.22	1.10	14	22
1/2	1/4	1171Px8x4S	.39	.81	.72	.26	2.26	1.20	17	17
1/2	3/8	1171Px8S	.39	.81	.72	.29	2.30	1.20	17	19
1/2	1/2	1171Px8x8S	.39	.83	.72	.34	2.36	1.20	17	22

Male Branch Tee Swivel

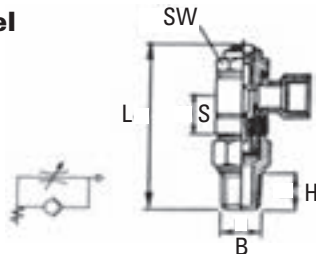

Swivel for installation purposes only.

TUBE O.D.	MALE PIPE THD.	CATALOG NUMBER	C	E	F	H	L	M	SW (MM)	SW1 (MM)
1/8	1/8	1172Px2S	.24	.59	.35	.20	1.61	9	12	12
5/32	1/8	1172Px2.5S	.24	.59	.35	.20	1.57	9	12	12
5/32	1/4	1172Px2.5x4S	.24	.63	.35	.26	1.57	9	14	14
1/4	1/8	1172Px4S	.27	.61	.46	.20	1.77	10	12	12
1/4	1/4	1172Px4x4S	.27	.65	.46	.26	1.77	10	14	14
1/4	3/8	1172Px4x6S	.27	.65	.46	.29	1.77	12	19	19
3/8	1/4	1172Px6S	.34	.77	.64	.26	2.20	14	14	14
3/8	3/8	1172Px6x6S	.34	.77	.64	.29	2.20	14	19	19
3/8	1/2	1172Px6x8S	.34	.79	.64	.34	2.20	14	22	22
1/2	3/8	1172Px8S	.39	.81	.72	.29	2.40	17	19	19

Brass Products

Mini-Barb

Note:
For additional technical questions, contact Technical Support at 1-888-258-0222.

 Refer to safety information regarding proper selection of tubing and tube connectors on page 1.

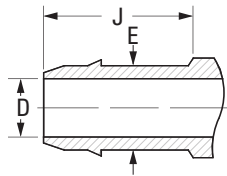
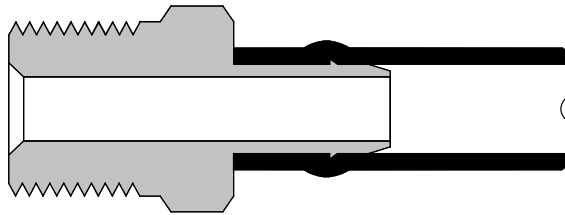
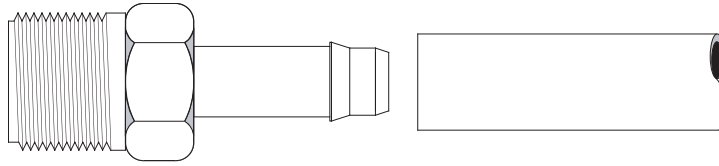

Common Dimensions of Barbed End.

TUBING O.D.	D	E	J
5/32	.062	.113	.38
*3/16	.078	.125	.50
1/4	.127	.189	.50
3/8	.196	.270	.50
1/2	.312	.395	.63

*No barb on 3/16" size.

Typical Application:

Temperature control circuits, test apparatus, lubricant, coolant lines, pneumatic circuits, vacuum and fluid systems.

Pressure:

Will withstand burst pressures of plastic tubing.

Vibration:

Excellent resistance.

Temperature Range:

Depends on tubing used.

Material:

CA360 Brass.

Used With:

PT240 Polyethylene tubing. See pages 22-26 for material compatibility and pages 27-29 for plastic tubing.

Advantages:

Quick connecting - no tube preparation. Hand assembly. Low cost one-piece push-on design. Barbed lip provides safe, positive connection. Compact size permits use in extremely tight areas.

Conformance:

An exclusive item with Eaton. User approvals only.

How to Order:

Individually by catalog number.

Note:

Refer to current price list for availability of cataloged items. Quotations and delivery of non-stock items supplied on request. Configurations and dimensions subject to change without notice.

Assembly Instructions:

1. Push the tubing over insert.
2. Bottom the tubing against connector body.

Label Set:

FS-1000 (adhesive)
CL-496 (non-adhesive)

Brass Products

Mini-Barb

Plug

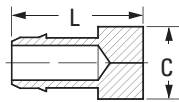
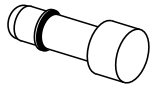

TUBING O.D.	CATALOG NUMBER	DIA. C	L
1/4	1073x4	.31	.75
3/8	1073x6	.40	.75
1/2	1073x8♦	.53	.88

♦MTO - Made To Order

Solder Connector

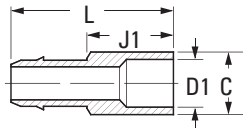
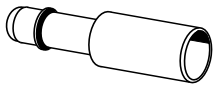

TUBING O.D.	SOLDER CONN.	CATALOG NUMBER	DIA. C	D1	J1	L
1/4	1/4	1079x4x4	5/16	.25	.50	1.00

Union

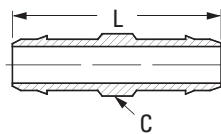
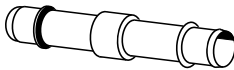

TUBING O.D.	CATALOG NUMBER	DIA. C	L
1/4x3/16*	1062x4x3	1/4	1.25
1/4	1062x4	1/4	.81
1/4	1062x4L	1/4	1.25
3/8x1/4	1062x6x4	5/16	1.19
3/8	1062x6	5/16	1.19
1/2x1/4	1062x8x4♦	1/2	1.33
1/2x3/8	1062x8x6	1/2	1.33
1/2	1062x8	1/2	1.45

*No barb on 3/16" end. "L" Suffix designates long Union.

♦MTO - Made To Order

Male Connector

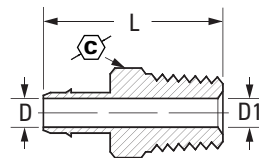
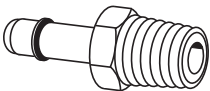

TUBING O.D.	MALE PIPE THREAD	CATALOG NUMBER	C	D	D1 OPT.	L
5/32	1/8	1068x2.5x2	7/16	.06	.19	.98
1/4	1/16	1068x4x1	5/16	.12	—	1.06
1/4	1/8	1068x4	7/16	.12	.19	1.06
1/4	1/4	1068x4x4	9/16	.12	.28	1.28
3/8	1/8	1068x6x2	7/16	.19	—	1.09
3/8	1/4	1068x6	9/16	.19	.28	1.28
1/2	3/8	1068x8	11/16	.31	—	1.38

Female Connector

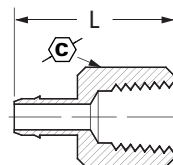
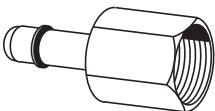

TUBING O.D.	FEM. PIPE THREAD	CATALOG NUMBER	C	L
1/4	1/8*	1066x4	1/2	1.00
1/4	1/4	1066x4x4	11/16	1.25
3/8	1/4	1066x6♦	11/16	1.25

*PTF Short Thread

♦MTO - Made To Order

Compression Connector

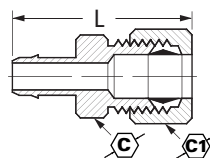
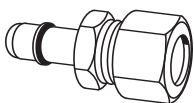

TUBING O.D.	COMP. TUBE SIZE	CATALOG NUMBER	C	C1	L
3/16*	1/4	1078x3x4	7/16	1/2	1.29
1/4	1/4	1078x4x4	7/16	1/2	1.29

*No Barb on 3/16" end

For replacement nuts and sleeves see page 42.

Brass Products

Mini-Barb

Bulkhead Compression Connector

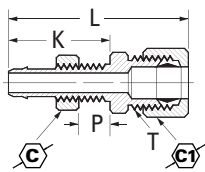
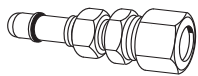

For replacement compression nuts and sleeves, see page 42.

TUBING O.D.	COMP. TUBE SIZE	CATALOG NUMBER	C	C1	K	L	MAX. P	THREAD T
1/4	1/4	1067x4x4	7/16	1/2	.88	1.66	.19	5/16-24 UNF

Bulkhead Union

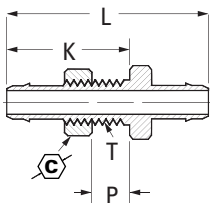
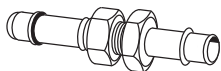

For replacement nuts and sleeves, see page 43.

TUBING O.D.	THREAD T	CATALOG NUMBER	C	K	L	MAX. P
1/4	5/16-24 UNF	1074x4	7/16	1.06	1.74	.31
3/8	3/8-24 UNF	1074x6	1/2	1.06	1.74	.31

Union Elbow

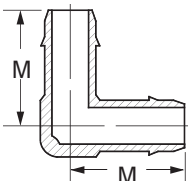
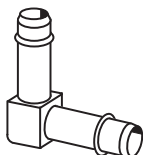

TUBING O.D.	CATALOG NUMBER	M
1/4	1065x4	.70
3/8	1065x6	.67
1/2	1065x8	.86

90° Male Elbow

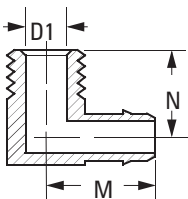
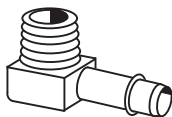

TUBING O.D.	MALE PIPE THREAD	CATALOG NUMBER	D1	M	N
1/4	1/16	1069x4x1	.156	.67	.55
1/4	1/8	1069x4	.250	.72	.63
1/4	1/4*	1069x4x4	.312	.78	.65
3/8	1/8	1069x6x2	.250	.74	.59
3/8	1/4*	1069x6	.312	.78	.62
1/2	3/8*	1069x8	.406	.98	.81

*PTF Short Thread

90° Female Elbow

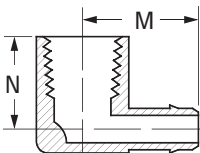
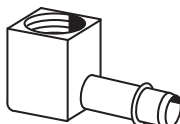

TUBING O.D.	FEM. PIPE THREAD	CATALOG NUMBER	M	N
1/4	1/8	1070x4	.75	.58
3/8	1/8	1070x6x2	.78	.48
3/8	1/4	1070x6	.84	.8

Brass Products

Mini-Barb

Union Tee

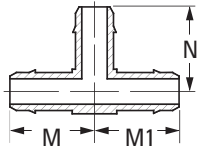
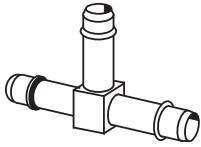

TUBING O.D.	CATALOG NUMBER	M	N	M1
1/4	1064x4	.70	.70	.70
3/8x3/8x1/4	1064x6x6x4	.70	.74	.70
3/8	1064x6	.68	.67	.68
3/8x1/2x3/8	1064x6x8x6	.67	.73	.79
1/2x1/2x1/4	1064x8x8x4	.82	.80	.82
1/2x1/2x3/8	1064x8x8x6	.79	.73	.79
1/2	1064x8	.86	.86	.86

Male Run Tee

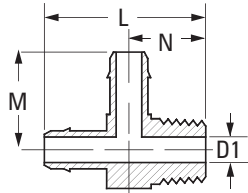
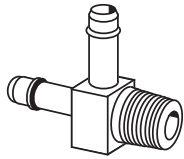

TUBING O.D.	MALE PIPE THREAD	CATALOG NUMBER	D1	L	M	N
1/4	1/8	1071x4	.188	1.21	.71	.59

*PTF Short Thread

Male Branch Tee

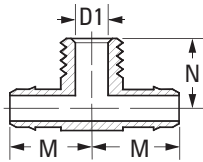
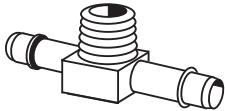

TUBING O.D.	MALE PIPE THREAD	CATALOG NUMBER	D1	M	N
1/4	1/8	1072x4	.188	.72	.59
3/8	1/8	1072x6x2	.188	.72	.59
3/8	1/4	1072x6	.312	.78	.62

Female Branch Tee

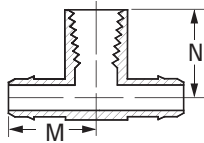
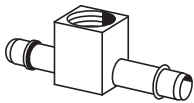

TUBING O.D.	FEMALE PIPE THREAD	CATALOG NUMBER	M	N
1/4	1/8	1077x4	.77	.48

Adapter Tee

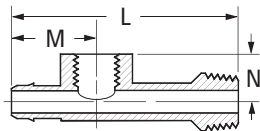
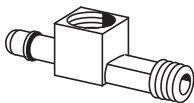

TUBING O.D.	M&F PIPE THREAD	CATALOG NUMBER	L	M	N
1/4	1/8*	1075x4	2.00	.75	.39

*PTF Special Short Thread

Brass Products

Quick>Connect Air Brake

Note:
For additional technical questions, contact Technical Support at 1-888-258-0222.

 Refer to safety information regarding proper selection of tubing and tube connectors on page 1.

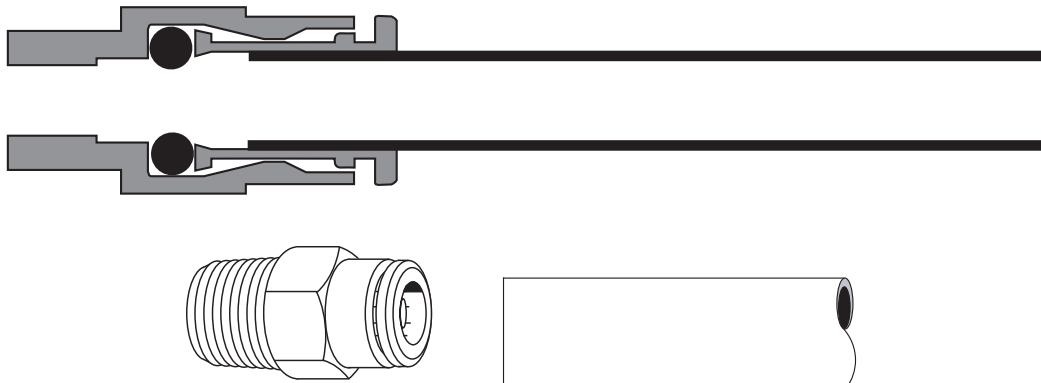

Typical Application:

Air brake systems except where temperatures exceed +200°F or where battery acid can drip on tubing. Not for fuel, water or oil.

Pressure:

Vacuum to 150 psi.

Vibration

Moderate vibration resistance.

Material:

CA360 Brass
(Body & Collet).

EP (Ethylene Propylene)
- o-ring.

Used With:

NT100 Nylon Tubing - SAE J844 Type A and B. See page 27 for NT100 Nylon Tubing data.

Temperature Range:

-40°F to +200°F
(-40°C to +93°C)

Advantages:

Easy, fast assembly, one-piece fitting, reusable Field Serviceable (See collet repair kits, page 83).

Used With:

Polyon NT100
AirBrake Tubing

Conformance:

Meets D.O.T. FMVSS 571.106 and SAE J1131 air brake system performance requirements.

How to Order:

Order individually by catalog number (parts are standard with thread sealant).

Label Set:

FS-3300 (adhesive)
CL-503 (non-adhesive)

Note:

Refer to current price list for availability of cataloged items. Quotations and delivery of non-stock items supplied on request. Configurations and dimensions subject to change without notice. Additional information can be found in SAE J2494.

Assembly Instructions:

See following page.

Cartridge Information

Encapsulated:

For insertion into single bore cavity in substitution for pipe thread ports. Meets proposed SAE specifications for encapsulated press in style Air Brake connectors. Note: Encapsulated Cartridges are specifically designed for installation into a thermoplastic (Nylon/Glass filled Nylon/Acetal) or a soft metal (Aluminum/Brass) cavity. For cavity dimensions contact Eaton Technical Support at 1-888-258-0222.

Four-Step Cartridge:

When you clean sheet a component design, the Four-Step Cartridge is an economical substitute for the encapsulated design. Special order only.

Select the design that is right for you. For applications where manifolds (manufactured from aluminum, plastic and brass) and air tanks (manufactured from steel and plastic composites) are used, contact Eaton Technical Support at 1-888-258-0222 for quotes based on your specific requirements and volumes.

Brass Products

Quick>Connect Air Brake

Assembly

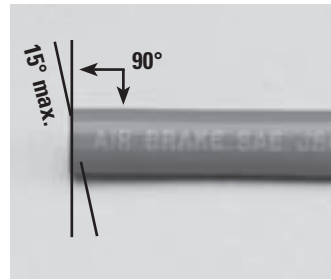

1. Using a tube cutter, make a square cut edge (maximum 15° cutting angle allowed).

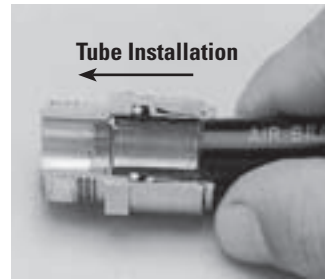

2. Insert tubing straight into connector until a solid stop is felt. The tubing grip and seal (on o-ring) is now accomplished.

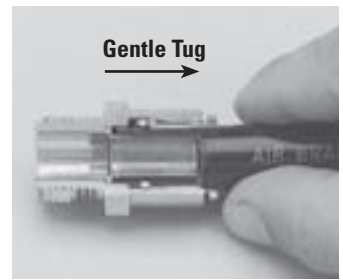

3. Gently tug on tubing to ensure tubing is secure.

Disassembly



1. Check to be sure there isn't any air pressure.



2. Depress collet head using fingers or tube-release tool to release grip on tubing.



3. With the collet depressed, pull the tubing from the connector.

Brass Products

Quick>Connect Air Brake

Note:
Use with NT100 Air Brake
Tubing (SAE J844),
see page 27.

Encapsulated Cartridge

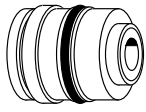

For design installation reference page 76
under Encapsulated heading.

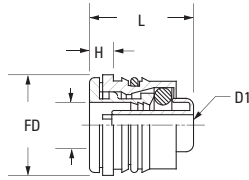

TUBE O.D.	CATALOG NUMBER	DIA F	L	D1	D	H
5/32	1861x2.5	.38	.62	.12	.165	.17
3/16	1861x3	.44	.62	.12	.195	.16
1/4	1861x4	.56	.65	.13	.263	.17
3/8	1861x6	.69	.81	.22	.388	.19
1/2	1861x8	.81	.83	.34	.513	.19
5/8	1861x10	.97	.99	.40	.638	.24
3/4	1861x12	1.12	.99	.52	.763	.24

Union

(Ref. SAE No. AA0101)

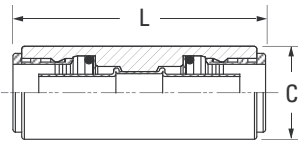

NOTE: Joins tubing

TUBE O.D.	CATALOG NUMBER	DIA C	L
5/32	1862x2.5	.44	1.41
3/16	1862x3	.44	1.62
1/4	1862x4	.53	1.62
3/8	1862x6	.69	1.94
1/2	1862x8	.83	1.96
5/8	1862x10	.96	2.51

Quick Connect Bulkhead Union

(Ref. SAE No. AA0601)

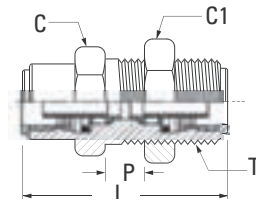
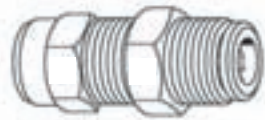

TUBE O.D.	THREAD T	CATALOG NUMBER	HEX C	HEX C1	L	MAX P
1/4	9/16-24	1874x4x4	5/8	11/16	1.62	.47
3/8	3/4-16	1874x6x6	7/8	15/16	1.96	.66
1/2	7/8-14	1874x8x8	1	1	2.00	.83
5/8	1-14	1874x10x10	1	1-1/4	2.42	1.00

Female Bulkhead Union

(Ref. SAE No. AA0603)

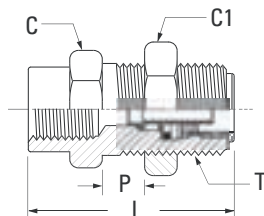
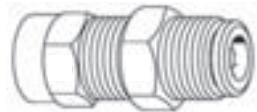

TUBE O.D.	THREAD T	FEMALE PIPE THREAD	CATALOG NUMBER	HEX C	HEX C1	L
1/4	9/16-24	1/4	1873x4x4	5/8	11/16	1.45
3/8	3/4-16	3/8	1873x6x6	7/8	15/16	1.59
1/2	1-14	1/2	1873x8x8	1	1-1/4	1.97

Brass Products

Quick>Connect Air Brake

Note:
Use with NT100 Air Brake
Tubing (SAE J844),
see page 27.

Male Connector

(Ref. SAE No. AA0102)

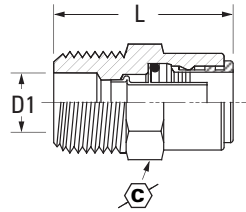
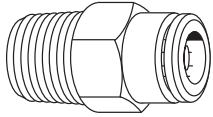

TUBE O.D.	MALE PIPE THREAD	CATALOG NUMBER		D1	L
5/32	1/16	1868x2.5x1	3/8	.09	.92
5/32	1/8	1868x2.5	7/16	.25	.92
3/16	1/8	1868x3	1/2	.25	.92
1/4	1/8	1868x4	9/16	.19	.95
1/4	1/4	1868x4x4	9/16	.34	1.18
1/4	3/8	1868x4x6	11/16	.41	1.17
3/8	1/8	1868x6x2	11/16	.19	1.33
3/8	1/4	1868x6	11/16	.31	1.29
3/8	3/8	1868x6x6	11/16	.41	1.27
3/8	1/2	1868x6x8	7/8	.53	1.47
1/2	1/4	1868x8x4	13/16	.31	1.46
1/2	3/8	1868x8	13/16	.41	1.35
1/2	1/2	1868x8x8	7/8	.53	1.50
5/8	3/8	1868x10x6	1	.41	1.72
5/8	1/2	1868x10	1	.53	1.71
3/4	1/2	1868x12	1-1/16	.53	1.72

Female Connector

(Ref. SAE No. AA0103)

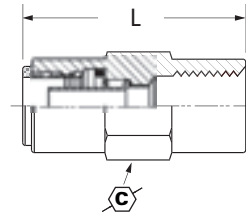
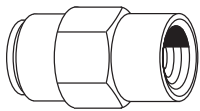

TUBE O.D.	FEMALE PIPE THREAD	CATALOG NUMBER		L
1/4	1/8	1866x4	9/16	1.33
1/4	1/4	1866x4x4	11/16	1.58
3/8	1/8	1866x6x2	11/16	1.45
3/8	1/4	1866x6	11/16	1.69
3/8	3/8	1866x6x6	13/16	1.75
1/2	1/4	1866x8x4	13/16	1.66
1/2	3/8	1866x8	13/16	1.73
1/2	1/2	1866x8x8	1	1.97

45° Male Elbow

(Ref. SAE No. AA0302)

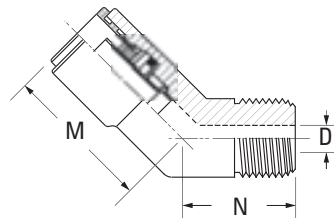
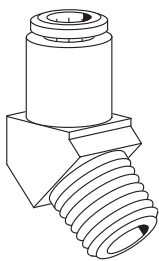

TUBE O.D.	MALE PIPE THREAD	CATALOG NUMBER	D1	M	N
1/4	1/8	1880x4	.19	.95	.59
1/4	1/4	1880x4x4	.31	.95	.59
3/8	1/8	1880x6x2	.25	1.05	.48
3/8	1/4	1880x6	.31	1.05	.69
3/8	3/8	1880x6x6	.41	1.10	.63
3/8	1/2	1880x6x8	.53	1.20	.70
1/2	1/4	1880x8x4	.31	1.20	.87
1/2	3/8	1880x8	.41	1.10	.73
1/2	1/2	1880x8x8	.53	1.10	.76
5/8	3/8	1880x10x6	.41	1.25	.82
5/8	1/2	1880x10	.53	1.39	.90
3/4	1/2	1880x12	.53	1.26	.98

Brass Products

Quick>Connect Air Brake

Note:
Use with NT100 Air Brake
Tubing (SAE J844),
see page 27.

45° Elbow - Swivel Male

(Ref. SAE No. AA03DD)

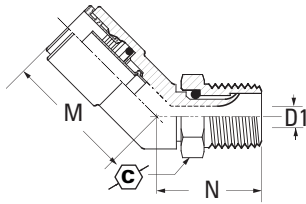
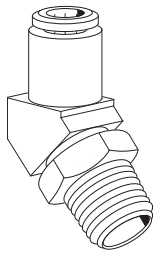

Swivel for installation purposes only.

TUBE O.D.	MALE PIPE THREAD	CATALOG NUMBER	D1	M	N	
1/4	1/8	1880x4S	.13	.82	.60	7/16
1/4	1/4	1880x4x4S	.22	.98	.60	9/16
3/8	1/8	1880x6x2S	.13	1.20	.68	7/16
3/8	1/4	1880x6S	.22	1.20	.89	9/16
3/8	3/8	1880x6x6S	.30	1.20	.97	11/16
1/2	1/4	1880x8x4S	.22	1.20	1.20	9/16
1/2	3/8	1880x8S	.30	1.04	1.07	11/16
1/2	1/2	1880x8x8S	.42	1.08	1.22	7/8

90° Union Elbow

(Ref. SAE No. AA0201)

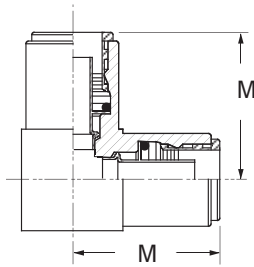
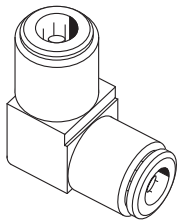

TUBE O.D.	CATALOG NUMBER	M
1/4	1865x4	.93
3/8	1865x6	1.15
1/2	1865x8	1.24

90° Male Elbow

(Ref. SAE No. AA0302)

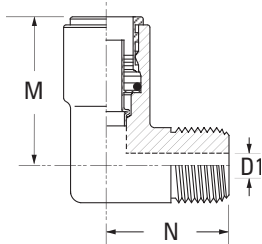
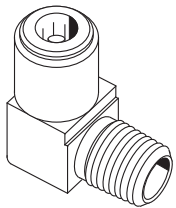

TUBE O.D.	MALE PIPE THREAD	CATALOG NUMBER	D1	M	N
5/32	1/16	1869x2.5x1	.13	.75	.59
5/32	1/8	1869x2.5	.19	.75	.59
3/16	1/8	1869x3	.19	.84	.69
1/4	1/8	1869x4	.19	.92	.68
1/4	1/4	1869x4x4	.31	.92	.81
1/4	3/8	1869x4x6	.41	1.03	.82
3/8	1/8	1869x6x2	.19	1.08	.80
3/8	1/4	1869x6	.31	1.13	.96
3/8	3/8	1869x6x6	.41	1.06	.98
3/8	1/2	1869x6x8	.53	1.27	1.07
1/2	1/4	1869x8x4	.31	1.23	1.00
1/2	3/8	1869x8	.41	1.25	.98
1/2	1/2	1869x8x8	.53	1.25	1.11
5/8	3/8	1869x10x6	.41	1.44	1.09
5/8	1/2	1869x10	.53	1.48	1.22

90° Male Elbow Long

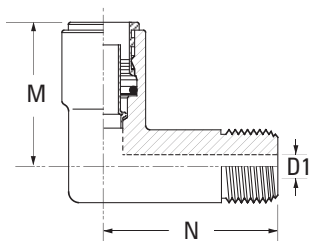
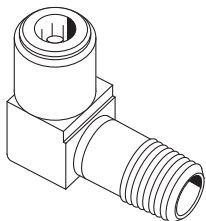

TUBE O.D.	MALE PIPE THREAD	CATALOG NUMBER	D1	M	N
3/8	1/4	1869x6L	.31	1.21	1.55

Brass Products

Quick>Connect Air Brake

Note:
Use with NT100 Air Brake
Tubing (SAE J844),
see page 27.

90° Swivel Male Elbow

(Ref. SAE No. AA02DD)

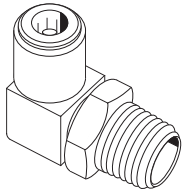

Swivel for installation purposes only.

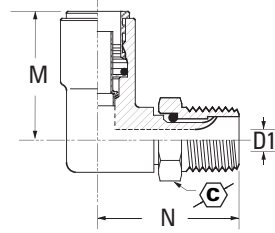

TUBE O.D.	MALE PIPE THREAD	CATALOG NUMBER	D1	M	N	
1/4	1/8	1869x4S	.13	.89	.88	7/16
1/4	1/4	1869x4x4S	.22	.99	1.06	9/16
1/4	3/8	1869x4x6S	.30	.98	1.06	11/16
3/8	1/8	1869x6x2S	.13	1.03	.97	7/16
3/8	1/4	1869x6S	.22	1.10	1.14	9/16
3/8	3/8	1869x6x6S	.30	1.12	1.15	11/16
3/8	1/2	1869x6x8S	.42	1.18	1.40	7/8
1/2	1/4	1869x8x4S	.22	1.08	1.20	9/16
1/2	3/8	1869x8S	.30	1.13	1.27	11/16
1/2	1/2	1869x8x8S	.42	1.20	1.47	7/8
5/8	3/8	1869x10x6S	.42	1.35	1.34	11/16
5/8	1/2	1869x10S	.42	1.38	1.54	7/8

90° Female Elbow

(Ref. SAE No. AA0203)

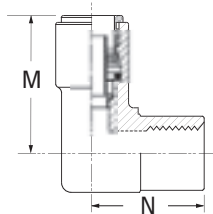
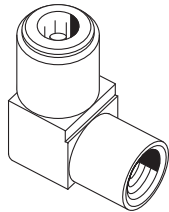

TUBE O.D.	FEMALE PIPE THREAD	CATALOG NUMBER	M	N
1/4	1/8	1870x4	1.03	.83
1/4	1/4	1870x4x4	1.04	.78
3/8	1/8	1870x6x2	1.13	.96
3/8	1/4	1870x6	1.28	1.09
3/8	3/8	1870x6x6	1.21	1.07
1/2	1/4	1870x8x4	1.25	1.11
1/2	3/8	1870x8	1.22	1.11
1/2	1/2	1870x8x8	1.33	1.07

Union Tee

(Ref. SAE No. AA0401)

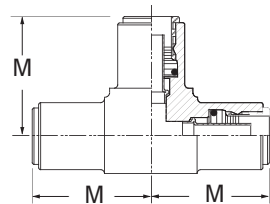
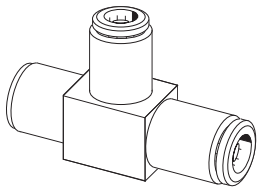

TUBE O.D.	CATALOG NUMBER	M
1/4	1864x4	.93
3/8	1864x6	1.15
1/2	1864x8	1.22

Male Run Tee

(Ref. SAE No. AA0424)

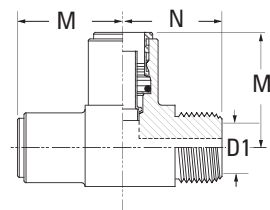
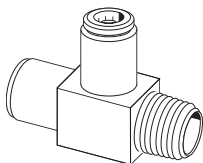

TUBE O.D.	MALE PIPE THREAD	CATALOG NUMBER	D1	M	M1	N
1/4	1/8	1871x4	.19	.93	.93	.64
1/4	1/4	1871x4x4	.19	.93	.94	.82
3/8	1/4	1871x6	.31	1.14	1.14	.91
3/8	3/8	1871x6x6	.41	1.15	1.15	.91
3/8x1/4	1/4	1871x6x4x4	.31	1.14	1.07	.96
3/8	1/2	1871x6x8	.53	1.09	1.08	1.11
1/2	3/8	1871x8	.41	1.09	1.10	1.22

Brass Products

Quick>Connect Air Brake

Note:
Use with NT100 Air Brake
Tubing (SAE J844),
see page 27.

Swivel Male Run Tee

(Ref. SAE No. AA04EE)

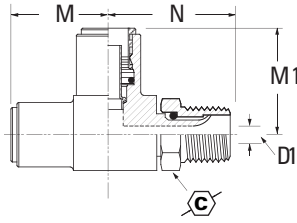
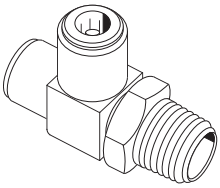

Swivel for installation purposes only.

TUBE O.D.	MALE PIPE THREAD	CATALOG NUMBER	D1	M	M1	N	
1/4	1/8	1871x4S	.13	.92	.92	.82	7/16
1/4	1/4	1871x4x4S	.22	.93	.92	1.07	9/16
3/8	1/4	1871x6S	.22	1.15	1.15	1.20	9/16
3/8	3/8	1871x6x6S	.30	1.15	1.15	1.20	11/16
1/2	1/4	1871x8x4S	.22	1.21	1.18	1.22	9/16
1/2	3/8	1871x8S	.30	1.21	1.23	1.34	11/16
1/2	1/2	1871x8x8S	.42	1.21	1.19	1.42	7/8

Male Branch Tee

(Ref. SAE No. AA0425)

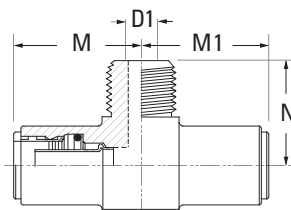
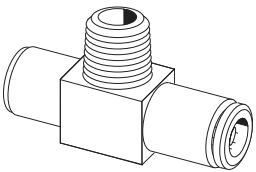

TUBE O.D.	MALE PIPE THREAD	CATALOG NUMBER	D1	M	M1	N
3/16	1/8	1872x3	.19	.75	.74	.64
1/4	1/8	1872x4	.19	.93	.93	.64
1/4	1/4	1872x4x4	.19	.93	.93	.82
3/8	1/4	1872x6	.31	1.15	1.15	.91
3/8	3/8	1872x6x6	.31	1.15	1.15	.92
1/2	1/4	1872x8x4	.31	1.22	1.22	.98
1/2	3/8	1872x8	.41	1.24	1.24	.99
1/2	1/2	1872x8x8	.53	1.22	1.22	1.12

Swivel Male Branch Tee

(Ref. SAE No. AA04FF)

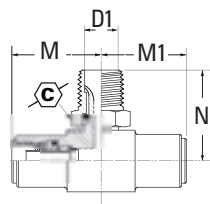
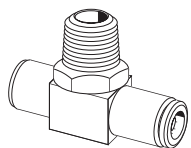

Swivel for installation purposes only.

TUBE O.D.	MALE PIPE THREAD	CATALOG NUMBER	D1	M	M1	N	
1/4	1/8	1872x4S	.13	.93	.93	.80	7/16
1/4	1/4	1872x4x4S	.22	.93	.93	1.04	9/16
3/8	1/8	1872x6x2S	.13	1.15	1.15	.94	7/16
3/8	1/4	1872x6S	.22	1.15	1.15	1.14	9/16
3/8	3/8	1872x6x6S	.30	1.15	1.15	1.17	11/16
1/2	1/4	1872x8x4S	.22	1.23	1.23	1.21	9/16
1/2	3/8	1872x8S	.30	1.24	1.24	1.24	11/16
1/2	1/2	1872x8x8S	.42	1.21	1.19	1.42	7/8

Female Branch Tee

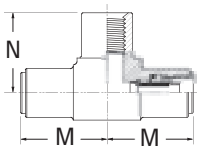
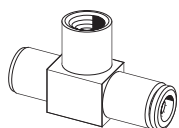

TUBE O.D.	FEMALE PIPE THREAD	CATALOG NUMBER	M	N
3/8	1/4	1877x6	1.16	.78

Brass Products

Quick>Connect Air Brake

Note:
Use with NT100 Air Brake
Tubing (SAE J844),
see page 27.

Adapter Tee

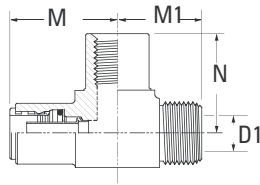
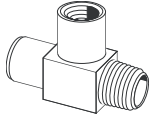

TUBE O.D.	MALE PIPE THREAD	FEMALE PIPE THREAD	CATALOG NUMBER	D1	M	N	M1
3/8	3/8	1/4	1883x6x6x4	.41	1.28	1.00	.95

Plugs, Pressure (Nylon)

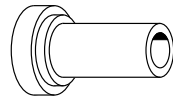

TUBE O.D.	CATALOG NUMBER
1/4	1829x4
3/8	1829x6
1/2	1829x8

1800T Collet Service Tool

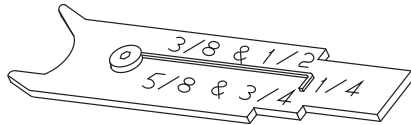

The Collet Service Tool, made from sturdy plated steel, is designed to assist in field servicing O-Rings of Q-CAB fittings. Use the half moon radius section to pry up and remove the collet

and use the movable piano wire to remove the O-Ring. Notches are used to mark the tubing with insertion depth in five tubing sizes.

1800TRK Tube Release Kit

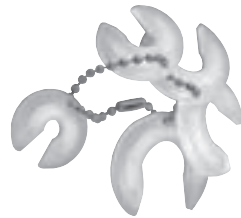

The 1800TRK tube release kit is designed to ease the removal of tubing from Q-CAB connectors. The individual tools are manufactured of a sturdy engineer-

ing plastic. All seven tube sizes currently offered in Q-CAB can be serviced with the five tools that make up the 1800TRK kit.

Collet Repair Kits

TUBE O.D.	REPAIR KIT PART #
5/32	1800Kx2.5
3/16	1800Kx3
1/4	1800Kx4
3/8	1800Kx6
1/2	1800Kx8
5/8	1800Kx10
3/4	1800Kx12

Consisting of a replacement collet and a replacement o-ring, the collet repair kits

provide an opportunity to repair damaged Q-CAB connectors.

Brass Products

Air Brake – Nylon Tubing

Note:
For additional technical questions, contact Technical Support at 1-888-258-0222.

 Refer to safety information regarding proper selection of tubing and tube connectors on page 1.

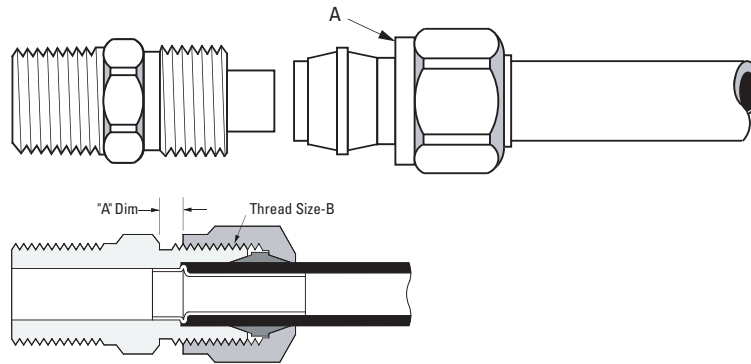

Tube O.D.	1/4	3/8	1/2	5/8	3/4
Thread Size-B	7/16-24	17/32-24	11/16-20	13/16-18	1-18

Typical Application:

Air brake systems except where temperatures exceed +200°F or where battery acid can drip on tubing.

Pressure:

Maximum operating pressure of 150 psi.

Vibration:

Fair resistance.

Temperature Range:

-40°F to +200°F
(-40°C to +93°C)

Material:

CA360 Brass.

Used With:

NT100 Nylon Tubing - SAE J844 Type A and B. See page 27 for NT100 Nylon Tubing data.

Advantages:

Easy to assemble (no tube preparation or flaring required.) Built in tube support. May be used with copper tubing by replacing nut, sleeve and insert with long nut and spherical sleeve. Insert should be removed for copper tubing use. See page 90 for details.

Conformance:

Meets specifications and standards of SAE and DOT FMVSS 571.106.

How to Order:

For complete assemblies (body, nuts and sleeves), order by catalog number. Example: 1468x4x4. To order body only (less nut and sleeve), add prefix "B" to catalog number and change "14" to "13." Example: B1368x4x4. Nuts, sleeve and insert can be ordered separately by catalog number.

To order complete assembly with pipe sealant (Seal-A-Thread), add suffix "Z" to catalog number. Example: 1468x4x4Z (special order only).

To order complete assembly with gauge ring, add suffix "K" to catalog number. Example: 1468x4x4K (special order only).

Note:

Refer to current price list for availability of cataloged items. Quotations and delivery of non-stock items supplied on request. Configurations and dimensions subject to change without notice. Additional information can be found in SAE J246.

Assembly Instructions:

1. Cut tubing to desired length.
2. Slide nut and then sleeve on tubing. Threaded end of nut "A" must face toward connector body.
3. Insert tubing into the pre assembled fitting. Be sure tubing is bottomed in connector.
4. Tighten nut to required torque as indicated on chart. Another check on proper assembly is dimension A also noted on chart. A gauge ring also assures installation to specification. See page 89.

TUBE SIZE	TORQUE	A DIMENSION
1/4	85 to 115 in. lbs.	.085/.105
3/8	12 to 17 ft. lbs.	.125/.145
1/2	25 to 33 ft. lbs.	.100/.120
5/8	26 to 35 ft. lbs.	.115/.135
3/4	38 to 50 ft. lbs.	.180/.200

Disassembly:

Remove nut and pull tubing out of connector body. Insert will remain in tubing.

Reassembly:

Push tubing and insert into connector body until it bottoms. Thread nut onto connector body and torque as in Step 4.

Label Set:

FS-900 (adhesive)
CL-497 (non-adhesive)

Brass Products

Air Brake – Nylon Tubing

Note:
Use with NT100 Air Brake Tubing (SAE J844), see page 27.

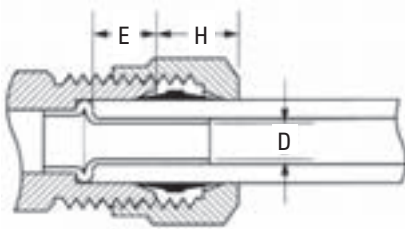

TUBE O.D.	E TUBE STOP	H*	D
1/4	.20	.32	.133
3/8	.26	.42	.215
1/2	.39	.45	.340
5/8	.39	.48	.398
3/4	.51	.50	.523

*H is hand tight dimensions.

Sleeve

(Ref. SAE No. 100115)

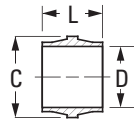

TUBE O.D.	CATALOG NUMBER	DIA. C	D	L
1/4	1460x4	.359	.256	.30
3/8	1460x6	.479	.384	.39
1/2	1460x8	.625	.509	.43
5/8	1460x10	.745	.635	.48
3/4	1460x12	.922	.760	.53

Nut

(Ref. SAE No. 100110)

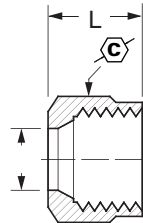
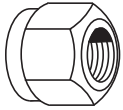

TUBE O.D.	CATALOG NUMBER	C	D	L
1/4	1461x4	9/16	.256	.45
3/8	1461x6	5/8	.384	.63
1/2	1461x8	13/16	.509	.72
5/8	1461x10	15/16	.634	.77
3/4	1461x12	1-1/8	.760	.81

Union

(Ref. SAE No. 100101BA)

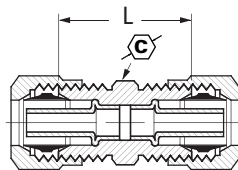
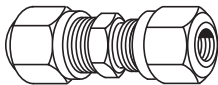

TUBE O.D.	CATALOG NUMBER	C	L
1/4	1462x4	7/16	.85
3/8	1462x6	9/16	1.10
1/2	1462x8	11/16	1.31
5/8	1462x10	13/16	1.43
3/4	1462x12	1	1.60

Brass Products

Air Brake – Nylon Tubing

Male Connector

(Ref. SAE No. 100102BA)

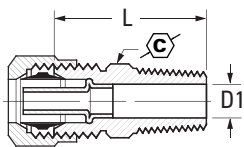
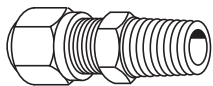

Note:

Use with NT100 Air Brake Tubing (SAE J844), see page 27.

TUBE O.D.	MALE PIPE THREAD	CATALOG NUMBER		D1	L
1/4	1/16	1468x4x1	7/16	.125	.90
1/4	1/8	1468x4	7/16	.188	.88
1/4	1/4	1468x4x4	9/16	.188	1.09
1/4	3/8	1468x4x6	11/16	.188	1.12
3/8	1/8	1468x6x2	9/16	.188	1.02
3/8	1/4	1468x6	9/16	.312	1.20
3/8	3/8	1468x6x6	11/16	.312	1.23
3/8	1/2	1468x6x8	7/8	.312	1.42
1/2	1/4	1468x8x4	11/16	.312	1.32
1/2	3/8	1468x8	11/16	.406	1.32
1/2	1/2	1468x8x8	7/8	.406	1.51
1/2	3/4	1468x8x12	1-1/16	.406	1.57
5/8	3/8	1468x10x6	13/16	.406	1.38
5/8	1/2	1468x10	7/8	.531	1.57
5/8	3/4	1468x10x12	1-1/16	.750	1.63
3/4	1/2	1468x12	1	.531	1.67
3/4	3/4	1468x12x12	1-1/16	.660	1.70

Female Connector

(Ref. SAE No. 100103BA)

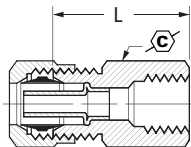
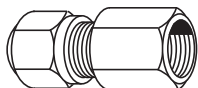

TUBE O.D.	FEM. PIPE THREAD	CATALOG NUMBER		L
1/4	1/8	1466x4	9/16	.85
3/8	1/8	1466x6x2♦	9/16	1.01
3/8	1/4	1466x6	11/16	1.19
3/8	3/8	1466x6x6	7/8	1.19
1/2	3/8	1466x8	7/8	1.28

♦MTO - Made To Order

Bulkhead Union

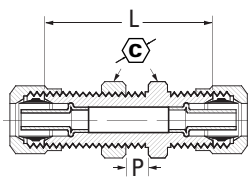
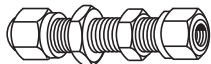

TUBE O.D.	CATALOG NUMBER		L	MAX. P
1/4	1474x4	9/16	1.38	.25
3/8	1474x6	11/16	1.62	.25
1/2	1474x8♦	13/16	1.88	.25

♦MTO - Made To Order

45° Male Elbow

(Ref. SAE No. 100302BA)

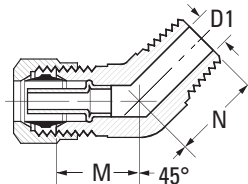
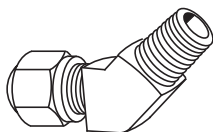

TUBE O.D.	MALE PIPE THREAD	CATALOG NUMBER	D1	M	N
1/4	1/8	1480x4	.188	.50	.64
1/4	1/4	1480x4x4	.312	.61	.86
3/8	1/4	1480x6	.312	.72	.86
3/8	3/8	1480x6x6	.406	.76	.95
1/2	1/4	1480x8x4	.312	.85	.95
1/2	3/8	1480x8	.406	.85	.95
1/2	1/2	1480x8x8	.531	.88	1.17
5/8	1/2	1480x10	.531	.94	1.17

Brass Products

Air Brake – Nylon Tubing

Union Elbow

(Ref. SAE No. 100201BA)

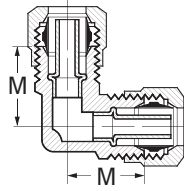
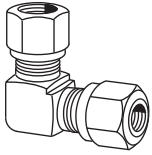

90° Male Elbow

(Ref. SAE No. 100202BA)

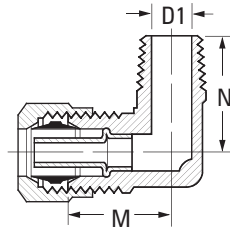
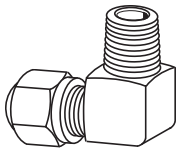

90° Male Elbow - Long

(Ref. SAE No. 100202BA)

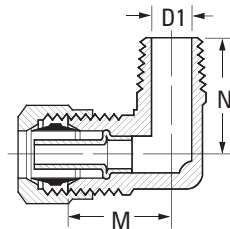
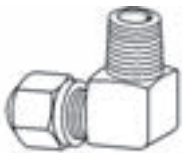

90° Female Elbow

(Ref. SAE No. 100203BA)

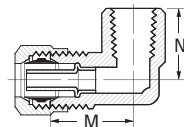
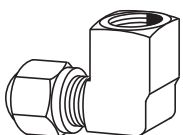

Note:

Use with NT100 Air Brake Tubing (SAE J844), see page 27.

TUBE O.D.	CATALOG NUMBER	M
1/4	1465x4♦	.63
3/8	1465x6♦	.80
1/2	1465x8♦	.94
5/8	1465x10♦	1.10

♦MTO - Made To Order

TUBE O.D.	MALE PIPE THREAD	CATALOG NUMBER	D1	M	N
1/4	1/8	1469x4	.188	.63	.67
1/4	1/4	1469x4x4	.312	.69	.88
1/4	3/8	1469x4x6	.406	.74	.87
3/8	1/8	1469x6x2	.188	.73	.75
3/8	1/4	1469x6	.312	.80	.93
3/8	3/8	1469x6x6	.406	.85	.92
3/8	1/2	1469x6x8	.531	.95	1.11
1/2	1/4	1469x8x4	.312	.87	1.00
1/2	3/8	1469x8	.406	.94	1.00
1/2	1/2	1469x8x8	.531	1.04	1.19
5/8	3/8	1469x10x6	.406	1.01	1.06
5/8	1/2	1469x10	.531	1.10	1.25
5/8	3/4	1469x10x12	.750	1.21	1.25
3/4	1/2	1469x12	.531	1.20	1.34

TUBE O.D.	MALE PIPE THREAD	CATALOG NUMBER	D1	M	N
3/8	1/4	1469x6L	.312	.80	1.44
1/2	3/8	1469x8L	.406	.94	1.38

TUBE O.D.	FEM. PIPE THREAD	CATALOG NUMBER	M	N
1/4	1/8	1470x4	.70	.54
3/8	1/4	1470x6♦	.90	.78
1/2	3/8	1470x8♦	1.04	.83

♦MTO - Made To Order

Brass Products

Air Brake – Nylon Tubing

Union Tee

(Ref. SAE No. 100401BA)

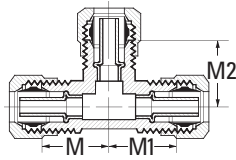
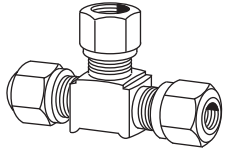

Dimensions read left, right, center.

Male Branch Tee

(Ref. SAE No. 100425BA)

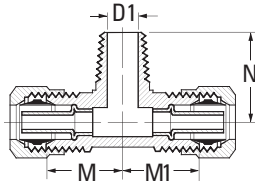
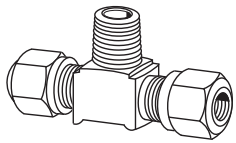

Female Branch Tee

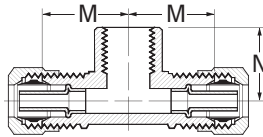
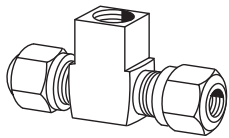

Male Run Tee

(Ref. SAE No. 100424BA)

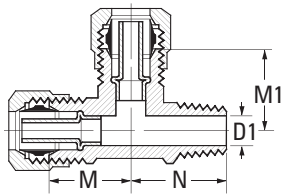
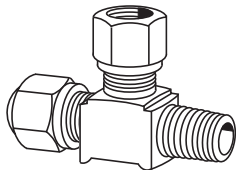

Note:

Use with NT100 Air Brake Tubing (SAE J844), see page 27.

TUBE O.D.	CATALOG NUMBER	M	M1	M2
1/4	1464x4	.63	.63	.63
3/8x3/8x1/4	1464x6x6x4	.72	.72	.69
3/8	1464x6	.80	.80	.80
1/2x1/2x3/8	1464x8x8x6	.86	.86	.85
1/2	1464x8	.94	.94	.94

TUBE O.D.	MALE PIPE THREAD	CATALOG NUMBER	D1	M	M1	N
1/4	1/8	1472x4	.188	.63	.63	.67
3/8x1/4	1/4	1472x6x4x4	.312	.80	.69	.93
3/8	1/8	1472x6x6x2♦	.188	.73	.73	.75
3/8	1/4	1472x6	.312	.80	.80	.93
3/8	3/8	1472x6x6x6	.406	.85	.85	.92
1/2x3/8	3/8	1472x8x6x6	.406	.94	.85	1.00
1/2	1/4	1472x8x8x4	.312	.87	.87	1.00
1/2	3/8	1472x8	.406	.94	.94	1.00

♦MTO - Made To Order

TUBE O.D.	FEM. PIPE THREAD	CATALOG NUMBER	M	N
3/8	1/4	1477x6	.90	.78
1/2	1/4	1477x8x8x4♦	.97	.83
5/8	1/4	1477x10x10x4	1.04	.89

♦MTO - Made To Order

TUBE O.D.	MALE PIPE THREAD	CATALOG NUMBER	D1	M	M1	N
1/4	1/8	1471x4	.188	.64	.64	.67
3/8x1/4	1/4	1471x6x4x4	.312	.72	.69	.88
3/8	1/4	1471x6	.312	.80	.80	.93
3/8	3/8	1471x6x6x6	.406	.85	.85	.92
1/2	3/8	1471x8♦	.406	.94	.94	1.10

♦MTO - Made To Order

Brass Products

Air Brake – Nylon Tubing

Adapter Tee

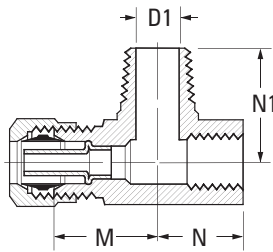
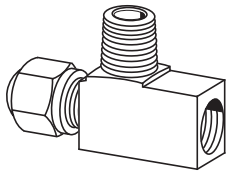

Note:

Use with NT100 Air Brake Tubing (SAE J844), see page 27.

TUBE O.D.	FEM. PIPE THREAD	MALE PIPE THREAD	CATALOG NUMBER	D1	M	N	N1
3/8	1/4	1/4	1482x6x4x4♦	.312	.88	.75	.94

♦MTO - Made To Order

Insert

(Brass)

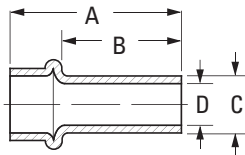
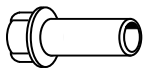

TUBE O.D.	CATALOG NUMBER	A	B	C	D
1/4	1484x4	.64	.46	.163	.133
3/8	1484x6	.76	.58	.245	.215
1/2	1484x8	.94	.76	.370	.340
5/8	1484x10	1.06	.84	.434	.398
3/4	1484x12	1.21	1.00	.559	.523

Gauge Ring

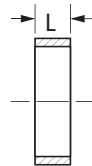

Nut screwed to Gauge Ring assures installation to specifications.

TUBE O.D.	CATALOG NUMBER	L
1/4	1485x4	.085/.105
3/8	1485x6	.125/.145
1/2	1485x8	.100/.120
5/8	1485x10	.115/.135
3/4	1485x12	.180/.200

Brass Products

Air-Brake Copper Tubing

Note:
For additional technical questions, contact Technical Support at 1-888-258-0222.

 Refer to safety information regarding proper selection of tubing on page 1.

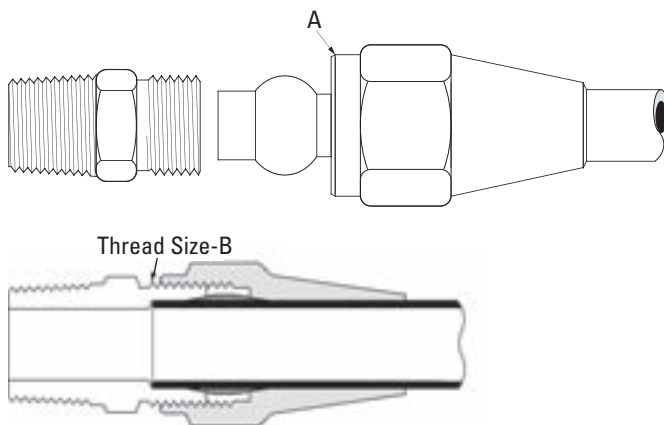

Tube O.D.	1/4	3/8	1/2	5/8	3/4	1
Thread Size-B	7/16-24	17/32-24	11/16-20	13/16-18	1-18	1-1/4-16

Typical Application:

Air brake systems.

Pressure:

Maximum operating pressure of 150 psi.

Vibration:

Fair resistance.

Temperature Range:

-65°F to +250°F (-53°C to +121°C) with copper tubing.

Material:

CA360 Brass.

Used With:

Copper tubing in air brake systems.

Advantages:

Easy to assemble (no flaring). May be used with nylon tubing by replacing long nut and spherical sleeve with insert, rigid sleeve and nut. See page 84 for details.

Conformance:

Meets specifications and standards of SAE and DOT.

How to Order:

For complete assemblies (body, nuts and sleeves), order by complete assembly number. Example: 1368x4. To order body only (less nut and sleeve), add prefix "B" to catalog number. Example: B1368x4. Nuts and sleeve can be ordered separately by catalog number.

To order complete assembly with pipe sealant (Seal-A-Thread), add suffix "Z" to catalog number. Example: 1368x4Z (special order only).

Note:

Refer to current price list for availability of cataloged items. Quotations and delivery of non-stock items supplied on request. Configurations and dimensions subject to change without notice. Additional information can be found in SAE J246.

Assembly Instructions:

1. Cut tubing to desired length. Make sure all burrs are removed and the ends are cut square.
2. Slide nut and then sleeve on tubing. Threaded end of nut "A" must face toward connector body.
3. Insert tubing into connector. Be sure tubing is bottomed on fitting shoulder.
4. Thread nut onto connector body until it is hand tight.
5. From that point, tighten with a wrench the number of turns indicated in the chart below.

TUBE SIZE	ADDITIONAL NUMBER OF TURNS FROM HAND TIGHT
1/4, 3/8	1-3/4
1/2, 5/8, 3/4	3-1/4

Label Set:

FS-800 (adhesive)
CL-491 (non-adhesive)

Brass Products

Air-Brake Copper Tubing

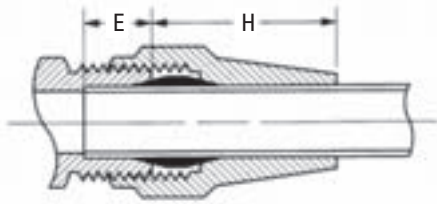

H is hand tight dimensions.

Sleeve

(Ref. SAE No. 120115)

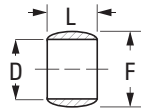

TUBE O.D.	E TUBE DEPTH	H
1/4	.25	.58
3/8	.31	.87
1/2	.44	.95
5/8	.44	1.05
3/4	.56	1.25

Nut

(Ref. SAE No. 120111)

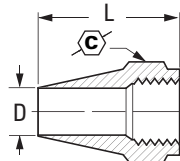
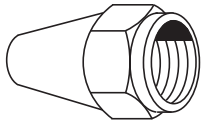

TUBE O.D.	CATALOG NUMBER	D	F	L
1/4	1360x4	.255	.322	.250
3/8	1360x6	.382	.461	.313
1/2	1360x8	.507	.594	.375
5/8	1360x10	.632	.734	.438
3/4	1360x12	.758	.874	.500

TUBE O.D.	CATALOG NUMBER	C	D	L
1/4	1361x4	9/16	.256	.75
3/8	1361x6	5/8	.384	1.13
1/2	1361x8	13/16	.509	1.25
5/8	1361x10	15/16	.634	1.38
3/4	1361x12	1-1/8	.760	1.56

Union

(Ref. SAE No. 120101BA)

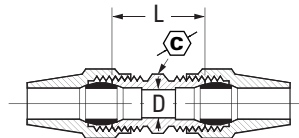
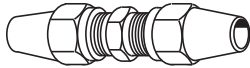

TUBE O.D.	CATALOG NUMBER	C	D	L
1/4	1362x4	7/16	.188	.85
3/8	1362x6	9/16	.312	1.10
1/2	1362x8	11/16	.406	1.31
5/8	1362x10	13/16	.531	1.43
3/4	1362x12	1	.656	1.60
1	1362x16	1-1/4	.875	1.78

Male Connector

(Ref. SAE No. 120102BA)

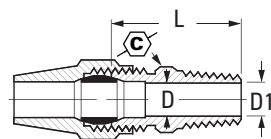

TUBE O.D.	MALE PIPE THREAD	CATALOG NUMBER	C	D	D1	L
1/4	1/8	1368x4	7/16	.188	.188	.88
1/4	1/4	1368x4x4	9/16	.188	.188	1.09
3/8	1/8	1368x6x2	9/16	.312	.188	1.02
3/8	1/4	1368x6	9/16	.312	.312	1.20
3/8	3/8	1368x6x6	11/16	.312	.406 opt.	1.23
3/8	1/2	1368x6x8	7/8	.312	.531 opt.	1.42
1/2	1/4	1368x8x4	11/16	.406	.312	1.32
1/2	3/8	1368x8	11/16	.406	.406	1.32
1/2	1/2	1368x8x8	7/8	.406	.531 opt.	1.51
5/8	3/8	1368x10x6	13/16	.531	.406	1.38
5/8	1/2	1368x10	7/8	.531	.531	1.57
3/4	1/2	1368x12	1	.656	.531	1.67
3/4	3/4	1368x12x12	1-1/16	.656	.719 opt.	1.70

Brass Products

Air-Brake Copper Tubing

Female Connector

(Ref. SAE No. 120103BA)

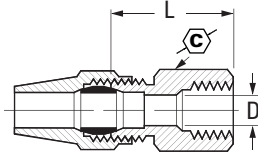
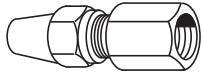

TUBE O.D.	FEM. PIPE THREAD	CATALOG NUMBER		D	L
3/8	1/4	1366x6	11/16	.312	1.19
3/8	3/8	1366x6x6	7/8	.312	1.19
1/2	3/8	1366x8	7/8	.406	1.28

45° Male Elbow

(Ref. SAE No. 120302BA)

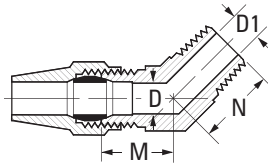
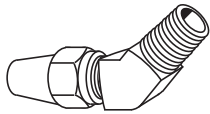

TUBE O.D.	MALE PIPE THREAD	CATALOG NUMBER	D	D1	M	N
3/8	1/4	1380x6	.312	.312	.72	.86
3/8	3/8	1380x6x6	.312	.406	.76	.95
1/2	3/8	1380x8	.406	.406	.85	.95
5/8	1/2	1380x10	.531	.531	.94	1.17

90° Male Elbow

(Ref. SAE No. 120202BA)

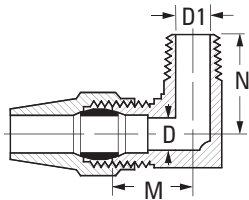
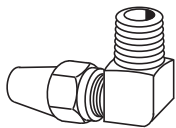

TUBE O.D.	MALE PIPE THREAD	CATALOG NUMBER	D	D1	M	N
1/4	1/8	1369x4	.188	.188	.63	.67
1/4	1/4	1369x4x4	.188	.312	.69	.88
3/8	1/8	1369x6x2	.312	.188	.73	.75
3/8	1/4	1369x6	.312	.312	.80	.93
3/8	3/8	1369x6x6	.312	.406	.85	.92
3/8	1/2	1369x6x8	.312	.531	.95	1.11
1/2	1/4	1369x8x4	.406	.312	.87	1.00
1/2	3/8	1369x8	.406	.406	.94	1.00
1/2	1/2	1369x8x8	.406	.531	1.04	1.19
5/8	3/8	1369x10x6	.531	.406	1.01	1.06
5/8	1/2	1369x10	.531	.531	1.10	1.25

90° Male Elbow - Long

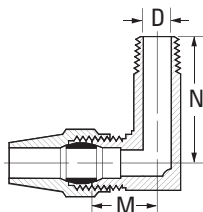
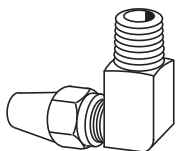

TUBE O.D.	MALE PIPE THREAD	CATALOG NUMBER	D	M	N
3/8	1/4	1369x6L	.312	.81	1.44
1/2	3/8	1369x8L	.406	1.25	1.38

Brass Products

Air-Brake Copper Tubing

Union Tee

(Ref. SAE No. 120401BA)

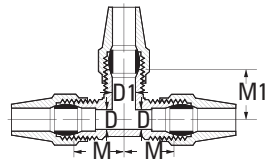
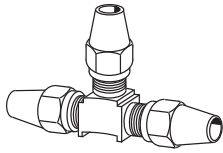

TUBE O.D.	CATALOG NUMBER	M	M1	D	D1
3/8	1364x6	.80	.80	.312	.312
1/2	1364x8	.94	.94	.406	.406

Male Run Tee

(Ref. SAE No. 120424BA)

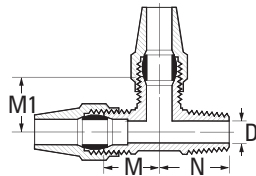
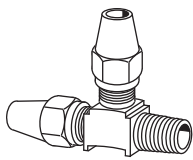

TUBE O.D.	MALE PIPE THREAD	CATALOG NUMBER	D	M	M1	N
3/8	1/4	1371x6	.312	.80	.80	.93
3/8	3/8	1371x6x6x6	.406	.85	.85	.92

Male Branch Tee

(Ref. SAE No. 120425BA)

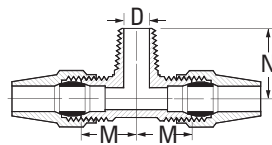
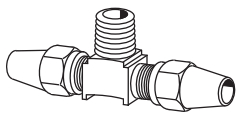

TUBE O.D. A	TUBE O.D. B	MALE PIPE THREAD	CATALOG NUMBER	D	M	N
3/8	3/8	1/4	1372x6	.312	.80	.93
3/8	3/8	3/8	1372x6x6x6	.406	.85	.92
1/2	1/2	3/8	1372x8	.406	.94	1.00

Bulkhead Coupling (Brass)

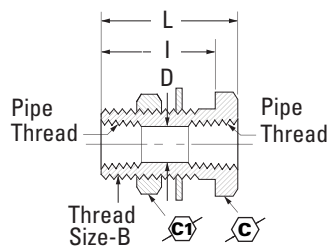
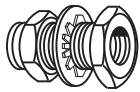

FEM. PIPE THREAD	CATALOG THREAD	THREAD SIZE B	C	C1	D	I	L
1/4	1344	3/4-16	1	15/16	.422	1.25	1.50
1/4	1345	3/4-16	1	15/16	.422	.69	.94
3/8	1346	1-14	1-1/8	1-3/8	.563	1.06	1.31
1/2	1351	1-1/8-14	1-1/4	1-3/8	.703	1.19	1.50

Brass Products

Air-Brake Copper Tubing

Bulkhead Coupling (Brass)

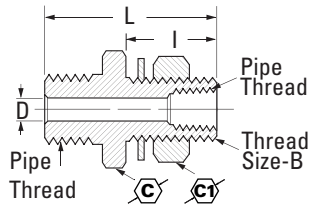
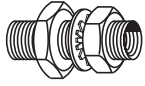

MALE PIPE THREAD	FEM. PIPE THREAD	CATALOG NUMBER	THREAD SIZE B	C	C1	D	I	L
1/2	1/4	1340	3/4-16	1-1/4	15/16	.312	1.13	2.16
1/2	1/4	1341	3/4-16	1-1/4	15/16	.312	1.53	2.53

Bulkhead Coupling (Brass)

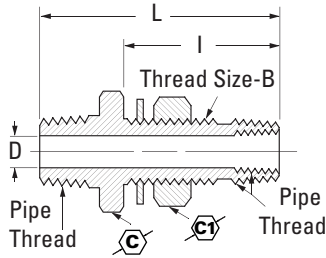
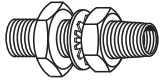

MALE PIPE THREAD	FEM. PIPE THREAD	CATALOG NUMBER	THREAD SIZE B	C	C1	D	I	L
1/2	1/4	1342	1-14	1-1/4	1-3/8	.375	1.88	2.94
1/2	1/4	1343	1-14	1-1/4	1-3/8	.375	2.88	3.94

Draincock

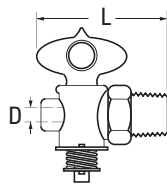

MALE PIPE THREAD	CATALOG NUMBER	D	L
1/4	W15310	.188	1.56

Shut Off Valve

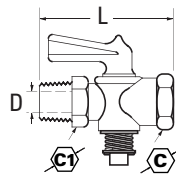
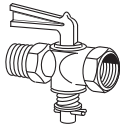

MALE PIPE THREAD	FEM. PIPE THREAD	CATALOG NUMBER	C	C1	D	L
1/4	1/4	W20332	5/8	3/4	.218	1.81

Rating: 125 psi with one 1/4" bubble in 5 seconds permissible key leakage.

External Seat Draincock

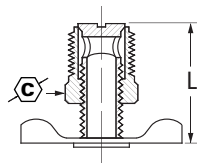
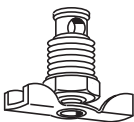

MALE PIPE THREAD	CATALOG NUMBER	C	L
1/4	145	9/16	1.00

Brass Products

Threaded Sleeve

Note:
For additional technical questions, contact Technical Support at 1-888-258-0222.

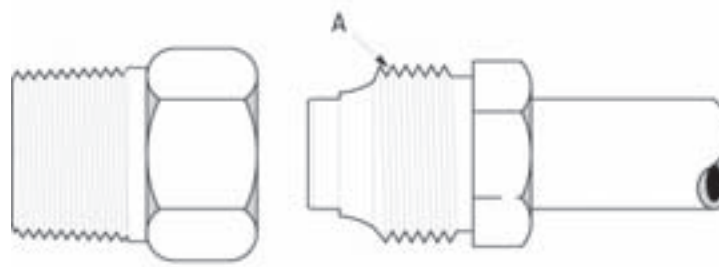

Thread Size B

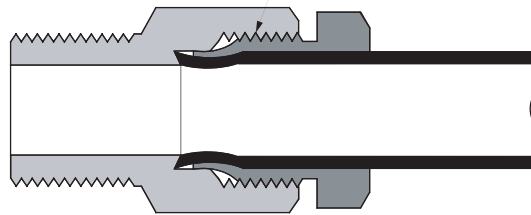

Tube O.D.	1/8	3/16	1/4	5/16	3/8
Thread Size-B	5/16-24	3/8-24	7/16-24	1/2-20	9/16-20

Typical Application:

Oil, air, water and lubrication systems.

Pressure:

Operating pressure of 500 psi for 1/8" to 1/4" sizes, 250 psi for 5/16" and 3/8" sizes.

Vibration:

Fair resistance.

Temperature Range:

-65°F to +250°F (-53°C to +121°C) range at maximum operating pressures.

Material:

CA360 Brass.

Used With:

Aluminum and copper tubing. Not recommended for steel tubing.

Advantages:

Easy to assemble, no flaring. Two (2) piece construction.

Conformance:

Meets ASA and ASME specifications.

How to Order:

Order individually by catalog number.

Note:

Refer to current price list for availability of cataloged items. Quotations and delivery of non-stock items supplied on request. Configurations and dimensions subject to change without notice.

Assembly Instructions:

1. Cut tubing to desired length.
2. Slide nut on end of tube. Threaded end "A" of nut must face toward connector.
- Note:**
The lead end of nut incorporates the sleeve as a single piece.
3. Insert tube into connector body. Be sure tube is bottomed on connector shoulder.
4. Lubricate threads and assemble nut to connector body.
5. From that point, tighten. Tighten nut, hand tight. From hand tight, tighten with a wrench 1-1/2 additional turns to form proper seal.

Brass Products

Threaded Sleeve

Nut

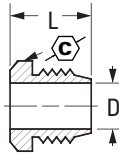
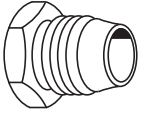

TUBE O.D.	CATALOG NUMBER		D	L
1/8	6100x2	3/8	.130	.50
3/16	6100x3	7/16	.193	.53
1/4	6100x4	1/2	.255	.56
5/16	6100x5♦	9/16	.318	.61
3/8	6100x6♦	5/8	.380	.61

♦MTO - Made To Order

Male Connector

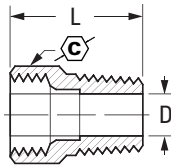
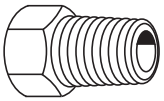

TUBE O.D.	MALE PIPE THREAD	CATALOG NUMBER		D	L
1/8	1/8	6200x2	7/16	.078	.62
1/8	*	6200x2x21	7/16	.080	.62
3/16	1/8	6200x3	7/16	.141	.69
1/4	1/8	6200x4	1/2	.188	.75
5/16	1/8	6200x5♦	9/16	.219	.89
3/8	1/4	6200x6♦	5/8	.312	.97

*Thread Size 1/4-28 Tapered Male Thread.

♦MTO - Made To Order

Male Elbow

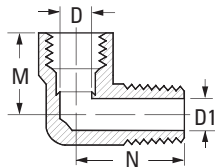
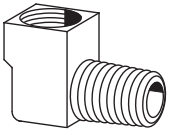

TUBE O.D.	MALE PIPE THREAD	CATALOG NUMBER	D	D1	M	N
1/8	1/8	6400x2	.073	.125	.50	.66
1/8	*	6400x2x21	.078	.080	.50	.52
3/16	1/8	6400x3	.141	.156	.56	.62
1/4	1/8	6400x4	.188	.188	.52	.62

*Thread Size 1/4-28 Tapered Male Thread.

♦MTO - Made To Order

Brass Products

Pipe

Note:
For additional technical questions, contact Technical Support at 1-888-258-0222.

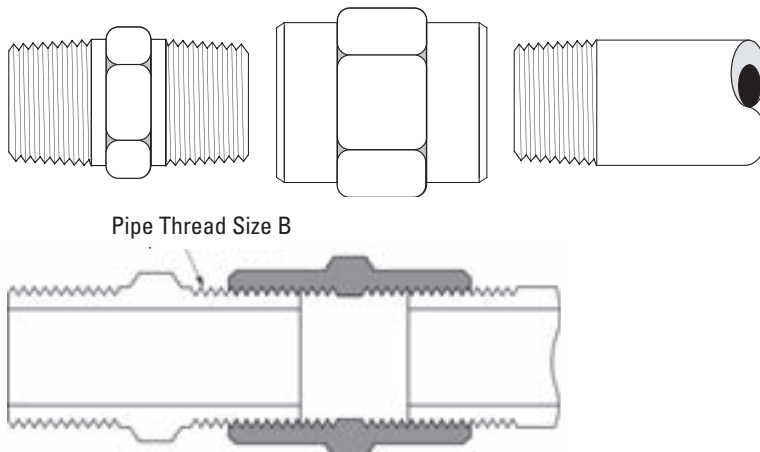

Pipe Size	1/16	1/8	1/4	3/8	1/2	3/4
Thread Size-B	1/16-27	1/8-27	1/4-18	3/8-18	1/2-14	3/4-14

Typical Application:

Grease, refrigeration, instrumentation and hydraulic systems. Fuel, LP and natural gas available on special order.

Pressure:

Operating pressure up to 1200 psi.

Vibration:

Fair resistance.

Temperature Range:

-65°F to +250°F
(-53°C to +121°C).

Material:

CA360 Brass.

Used With:

Brass, bronze and iron pipe.

Advantages:

Dryseal pipe threads (NPTF). Large range of sizes and configurations.

Conformance:

Listed by Underwriters Laboratories (available on special order) for fuel equipment, refrigeration and gas. Meets specifications and standards of ASA, ASME and SAE.

How to Order:

Order individually by catalog number. Example: 3325x4. To order with pipe sealant (Seal-A-Thread), add a "Z" suffix to the catalog number. (Special order only). Example: 3325x4Z.

Note:

Refer to current price list for availability of cataloged items. Quotations and delivery of non-stock items supplied on request. Configurations and dimensions subject to change

without notice. Additional information can be found in SAE J530 Automotive Pipe Fittings and SAE J531 Drain Plugs.

Assembly Instructions:

1. Tighten approximately 2-1/2 turns past hand tight.
2. Connectors with Seal-A-Thread tighten two turns past hand tight. Brittle materials require special cautions.

Label Set:

W-8022 (adhesive)
CL-490 (non-adhesive)

Brass Products

Pipe

Cap

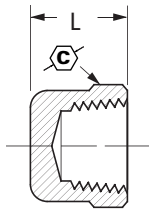

FEM. PIPE THREAD	CATALOG NUMBER	C	L
1/8*	3129x2	9/16	.50
1/4*	3129x4	11/16	.59
3/8*	3129x6	13/16	.68

*PTF Short Thread

Slotted Plug

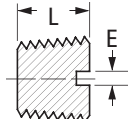

MALE PIPE THREAD	CATALOG NUMBER	E	L
1/8*	3150x2	.05	.28
1/4*	3150x4	.08	.42
3/8*	3150x6	.09	.43

*PTF Short Thread

Square Head Plug

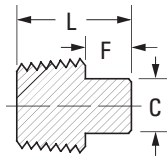
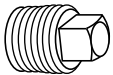

MALE PIPE THREAD	CATALOG NUMBER	SQUARE C	F	L
1/8*	3151x2	.28	.24	.58
1/4*	3151x4	.37	.29	.74
3/8*	3151x6	.43	.32	.82
1/2*	3151x8	.56	.39	.99
3/4*	3151x12	.62	.43	1.12

*PTF Short Thread

Hex Head Plug

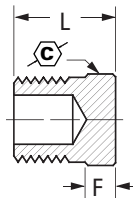
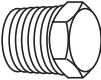

MALE PIPE THREAD	CATALOG NUMBER	C	F	L
1/8*	3152x2	7/16	.19	.57
1/4*	3152x4	9/16	.18	.62
3/8*	3152x6	11/16	.22	.72
1/2*	3152x8	7/8	.22	.78
3/4**	3152x12	1-1/16	.25	.88

*PTF Short Thread

**PTF Special Short Thread

Hex Socket Plug

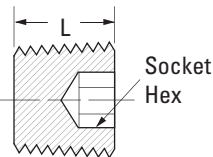

MALE PIPE THREAD	CATALOG NUMBER	SOCKET HEX	L
1/8	3153x2	3/16	.270
1/4	3153x4♦	1/4	.410
3/8	3153x6♦	5/16	.410
1/2	3153x8♦	3/8	.540

♦MTO - Made To Order

Adapter

(Ref. SAE No. 130139)

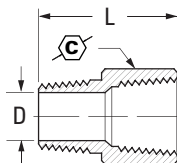
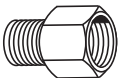

FEM. PIPE THREAD	MALE PIPE THREAD	CATALOG NUMBER	C	D	L
1/8	1/8	3200x2	9/16	.219	.88
1/4	1/8	3200x4x2	3/4	.219	1.06
1/4	1/4	3200x4	3/4	.312	1.25
3/8	1/4	3200x6x4	7/8	.312	1.25
3/8	3/8	3200x6	7/8	.438	1.25
1/2	3/8	3200x8x6	1-1/16	.438	1.47
3/4	3/8	3200x12x6	1-1/4	.438	1.59
3/4	1/2	3200x12x8	1-1/4	.562	1.69

Brass Products

Pipe

Bushing

(Ref. SAE No. 130140)

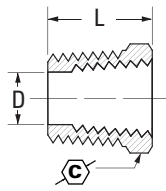
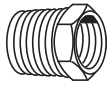

MALE PIPE THREAD	FEM. PIPE THREAD	CATALOG NUMBER	C	D	L
1/4*	1/8	3220x4x2	5/8	.339	.59
3/8	1/8	3220x6x2	11/16	.328	.75
3/8*	1/4	3220x6x4	11/16	.438	.69
1/2*	1/8	3220x8x2	7/8	.530**	.75
1/2*	1/4	3220x8x4	7/8	.438**	.75
1/2*	3/8	3220x8x6	7/8	.562	.75
3/4*	3/8	3220x12x6	1-1/8	.562	.88
3/4*	1/2	3220x12x8	1-1/8	.703	.88

*PTF Short Thread

**Optional Counterbore

Union

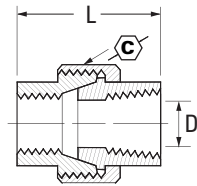
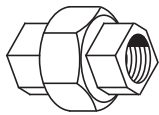

FEM. PIPE THREAD	CATALOG NUMBER	C	D	L
1/4*	3250x4	1-1/16	.438	1.31
1/2	3250x8	1-9/16	.703	1.81

*PTF Short Thread

Coupling

(Ref. SAE No. 130138)

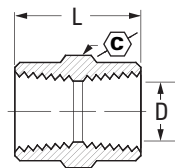
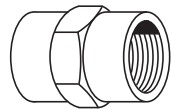

FEM. PIPE THREAD	CATALOG NUMBER	C	D	L
1/16	3300x1	7/16	.339	.75
1/8	3300x2	9/16	.339	.75
1/4	3300x4	3/4	.438	1.12
3/8	3300x6	7/8	.578	1.12
1/2	3300x8	1-1/16	.703	1.50
3/4	3300x12	1-1/4	.906	1.53

Reducer Coupling

(Ref. SAE No. 130138)

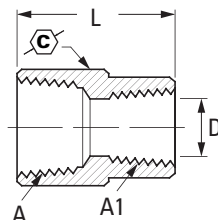
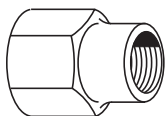

FEM. PIPE THREAD A	FEM. PIPE THREAD A1	CATALOG NUMBER	C	D	L
1/4	1/8	3300x4x2	3/4	.339	.96
3/8	1/8	3300x6x2	7/8	.339	.94
3/8	1/4	3300x6x4	7/8	.438	1.16
1/2	3/8	3300x8x6	1-1/16	.562	1.38

Restriction Pipe Adapter

(With .0625 Orifice)

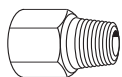

MALE PIPE THREAD	FEMALE PIPE THREAD	CATALOG NUMBER	C	D	L
1/8	1/8*	1512	1/2	.0625	.75

*PTF Short Thread

NOTE: Other orifice sizes available (special order only).

Brass Products

Pipe

Hex Nipple

(Ref. SAE No. 130137)

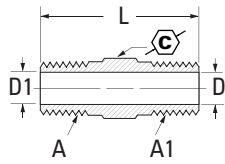
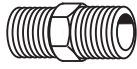

MALE PIPE THREAD A	MALE PIPE THREAD A1	CATALOG NUMBER		D	D1	L
1/16	1/16	3325x1	3/8	.125	.125	.978
1/8	1/16	3325x2x1	7/16	.230	.156	.955
1/8	1/8	3325x2	7/16	.219	.219	.97
1/4	1/8	3325x4x2	9/16	.219	.219*	1.19
1/4	1/4	3325x4	9/16	.312	.312	1.38
3/8	1/8	3325x6x2	11/16	.219	.438	1.22
3/8	1/4	3325x6x4	11/16	.312	.438	1.41
3/8	3/8	3325x6	11/16	.438	.438	1.41
1/2	1/2	3325x8	7/8	.562	.562	1.81
3/4	3/4	3325x12	1-1/16	.750	.750	1.94

*Optional .312 Counterbore on 1/4" side.

Close Nipple

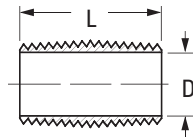
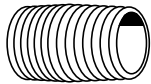

MALE PIPE THREAD	CATALOG NUMBER	D	L
1/8	3326x2	.281	.75
1/4	3326x4	.375	.88
3/8	3326x6	.500	1.00
1/2	3326x8	.625	1.12
3/4	3326x12	.750	1.38

Long Nipple

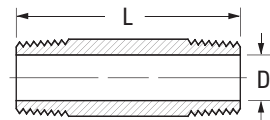

MALE PIPE THREAD	CATALOG NUMBER	D	L
1/8	3327x2	.281	1.50
1/8	3328x2	.281	2.00
1/8	3329x2	.281	2.50
1/8	3330x2	.281	3.00
1/8	3331x2♦	.281	3.50
1/4	3327x4	.375	1.50
1/4	3328x4	.375	2.00
1/4	3329x4	.375	2.50
1/4	3330x4	.375	3.00
1/4	3331x4	.375	3.50
3/8	3327x6	.480	1.50
3/8	3328x6	.490	2.00
3/8	3329x6	.480	2.50
3/8	3330x6	.480	3.00
3/8	3331x6♦	.480	3.50
1/2	3328x8	.625	2.00
1/2	3329x8	.625	2.50
1/2	3330x8	.625	3.00
3/4	3328x12♦	.750	2.00
3/4	3329x12	.750	2.50

♦MTO - Made To Order

Brass Products

Pipe

Bulkhead Coupling (Brass)

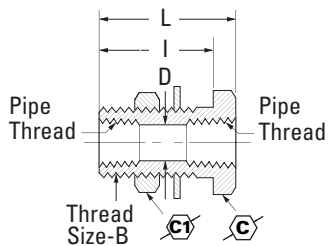
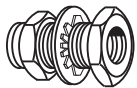

FEM. PIPE THRD.	CATALOG NUMBER	THREAD SIZE B	C	C1	D	I	L
1/4	1344	3/4-16	1	15/16	.422	1.25	1.50
1/4	1345	3/4-16	1	15/16	.422	.69	.94
3/8	1346	1-14	1-1/8	1-3/8	.563	1.06	1.31
1/2	1351	1-1/8-14	1-1/4	1-3/8	.703	1.19	1.50

Bulkhead Coupling (Brass)

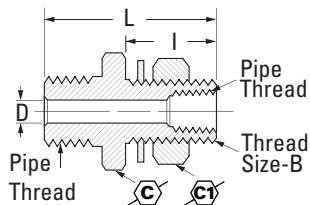
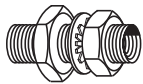

MALE PIPE THD.	FEM. PIPE THD.	CATALOG NUMBER	THREAD SIZE B	C	C1	D	I	L
1/2	1/4	1340	3/4-16	1-1/4	15/16	.312	1.13	2.16
1/2	1/4	1341	3/4-16	1-1/4	15/16	.312	1.53	2.53

Bulkhead Coupling (Brass)

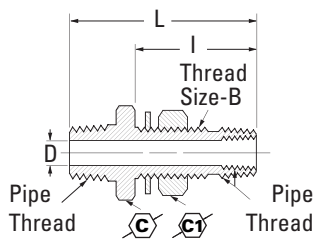
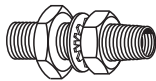

MALE PIPE THD.	FEM. PIPE THD.	CATALOG NUMBER	THREAD SIZE B	C	C1	D	I	L
1/2	1/4	1342	1-14	1-1/4	1-3/8	.375	1.88	2.94
1/2	1/4	1343	1-14	1-1/4	1-3/8	.375	2.88	3.94

45° Street Elbow

(Ref. SAE No. 130339)

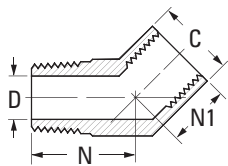

MALE PIPE THRD.	FEM. PIPE THRD.	CATALOG NUMBER	C	D	N	N1
1/8	1/8	3350x2	9/16	.219	.50	.38
1/4	1/4	3350x4	11/16	.312	.74	.56
3/8	3/8	3350x6	13/16	.438	.78	.56
1/2	1/2	3350x8	1	.562	1.00	.76
3/4	3/4	3350x12	1-1/4	.750	1.06	.75

90° Street Elbow

(Ref. SAE No. 130239)

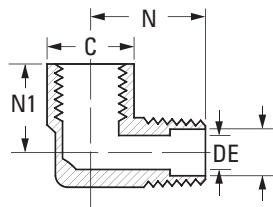
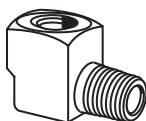

FEM. PIPE THRD.	MALE PIPE THRD.	CATALOG NUMBER	C	D	E	N	N1
1/8	1/8	3400x2	9/16	.219	.25	.66	.47
1/8*	1/8**	3400x2W	1/2	.188	.25	.57	.34
1/4	1/8	3400x4x2	11/16	.219	—	.72	.53
1/4*	1/4**	3400x4W	11/16	.266	.36	.78	.45
1/4	1/4	3400x4	11/16	.312	—	.91	.72
3/8	3/8	3400x6	13/16	.438	—	.97	.78
1/2	1/2	3400x8	1	.562	—	1.25	1.03
3/4	3/4	3400x12	1-1/4	.750	—	1.38	1.12

*PTF short thread.

**PTF special short thread.

Brass Products

Pipe

90° Elbow

(Ref. SAE No. 130238)

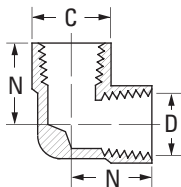
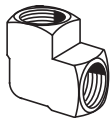

FEM. PIPE THREAD	CATALOG NUMBER	C	D	N
1/8	3500x2	9/16	.339	.55
1/4	3500x4	11/16	.438	.78
3/8	3500x6	13/16	.562	.84
1/2	3500x8	1	.703	1.09
3/4	3500x12	1-1/4	.906	1.16

Male Branch Tee

(Ref. SAE No. 130425)

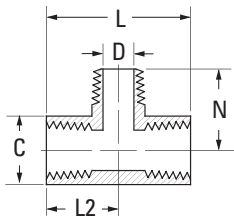
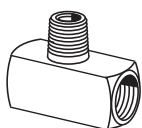

FEM. PIPE THREAD	MALE PIPE THREAD	CATALOG NUMBER	C	D	L	L2	N
1/8	1/8	3600x2	9/16	.219	1.10	.55	.66
1/4	1/4	3600x4	11/16	.312	1.56	.78	.91
3/8	3/8	3600x6	13/16	.438	1.68	.84	.97
1/2	1/2	3600x8	1	.562	2.18	1.09	1.25
3/4	3/4	3600x12	1-1/4	.750	2.31	1.16	1.38

Tee

(Ref. SAE No. 130438)

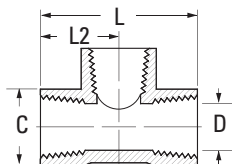
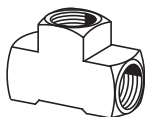

FEM. PIPE THREAD	CATALOG NUMBER	C	D	L	L2
1/8	3700x2	9/16	.339	1.10	.55
1/4	3700x4	11/16	.438	1.56	.78
3/8	3700x6	13/16	.562	1.68	.84
1/2	3700x8	1	.703	2.18	1.09
3/4	3700x12	1-1/4	.906	2.32	1.16

Male Run Tee

(Ref. SAE No. 130424)

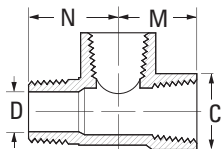
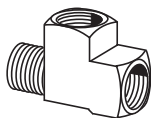

FEM. PIPE THREAD	MALE PIPE THREAD	CATALOG NUMBER	C	D	M	N
1/8	1/8	3750x2	9/16	.219	.55	.66
1/4	1/4	3750x4	11/16	.312	.78	.90
3/8	3/8	3750x6	13/16	.438	.84	.97
1/2	1/2	3750x8	1	.562	1.09	1.25
3/4	3/4	3750x12	1-1/4	.750	1.16	1.38

Cross

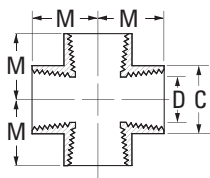
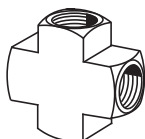

FEM. PIPE THREAD	CATALOG NUMBER	C	D	M
1/8	3950x2	1/2	.339	.50
1/4	3950x4	11/16	.438	.75
3/8	3950x6	7/8	.562	.81
1/2	3950x8	1	.703	1.09

Brass Products

Needle Valves

Note:
For additional technical questions, contact Technical Support at 1-888-258-0222.

 Refer to safety information regarding proper selection of tubing on page 1.

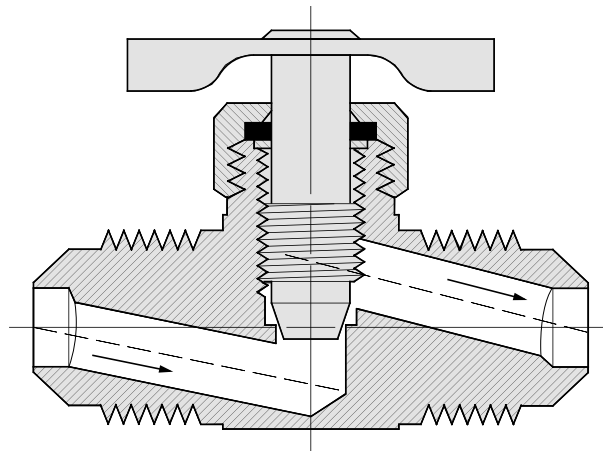

Typical Application:

Instrumentation, hydraulic and pneumatic systems.

Pressure:

150 psi maximum. (Does not include plastic tubing.)

Temperature Range:

-65°F to +250°F (-53°C to +121°C) with metal tubing. For valves using compatible tubing, refer to the tubing temperature range.

Material:

Brass bodies, steel handles except where noted. Polyline valves have brass bodies and brass handles.

Used With:

Copper, aluminum, steel and plastic tubing where applicable.

Advantages:

Metal-to-metal seat, with fine thread screw down, enables valves to seat positively, adjust easily and hold to any amount of flow up to capacity of the valve.

Conformance:

Designed for automotive and industrial use. Not intended for natural gas, LPG, nuclear or aircraft applications.

How to Order:

Order valve body, nuts and sleeves by catalog number. Order valve with Selfalign nuts and sleeves by adding suffix "S". Example: A6763 becomes A6763S. Order valves less nuts and sleeves by adding prefix "B". Example: A6763 becomes B6763.

Assembly Instructions:

Install with the pressure against the seat. Inspection of a straight valve discloses one opening to be higher than the other. Pressure should always be directed against the seat in angle valves, not the stem threads.

Brass Products

Needle Valves

Compression Double

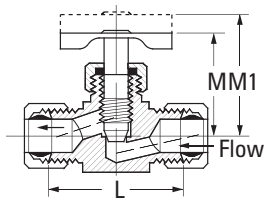
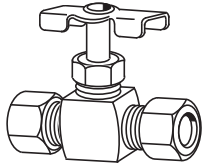

TUBE O.D.	CATALOG NUMBER	L	M	M1
3/16	A6763	1.06	.88	1.03
1/4	A6765	1.13	.88	1.03
1/4	A6765S	1.13	.88	1.03
5/16	A6770	1.13	.88	1.03
3/8	A6775	1.50	1.13	1.31

"S" suffix designates Selfalign with nuts and sleeves.

Compression Straightway

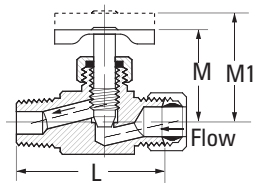
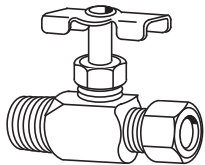

TUBE O.D.	MALE PIPE THREAD	CATALOG NUMBER	L	M	M1
3/16	1/8	A6690	1.16	.88	1.03
3/16	1/8	A6690S	1.16	.88	1.03
1/4	1/8	A690	1.19	.88	1.03
1/4	1/8	A690S	1.19	.88	1.03
5/16	1/8	A660	1.18	.90	1.05
5/16	1/4	A6755	1.28	.91	1.09
5/16	1/4	A6755S	1.28	.91	1.09
3/8	1/4	A6760	1.82	1.31	1.46
3/8	1/4	A6760S	1.82	1.31	1.46

"S" suffix designates Selfalign with nuts and sleeves.

Compression Angle

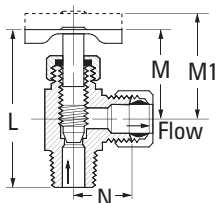
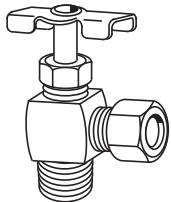

TUBE O.D.	MALE PIPE THREAD	CATALOG NUMBER	L	M	M1	N
3/16	1/8	A6845	1.50	.82	1.07	.50
1/4	1/8	A555	1.53	.83	1.05	.53
1/4	1/8	A555S	1.53	.83	1.05	.53
5/16	1/8	A655	1.56	.84	1.09	.52
5/16	1/4	A6855	1.73	.92	1.28	.69
5/16	1/4	A6855S	1.73	.92	1.28	.69
3/8	1/4	A6860	1.64	.83	1.28	.78
3/8	1/4	A6860S	1.64	.83	1.28	.78

"S" suffix designates Selfalign with nuts and sleeves.

Inverted Straightway

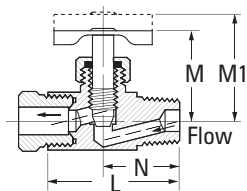
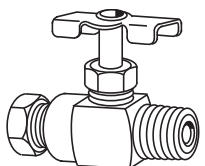

TUBE O.D.	MALE PIPE THREAD	CATALOG NUMBER	L	M	M1	N
1/4	1/8	A735	1.38	.84	1.01	.69
1/4	1/8	B735	1.38	.84	1.01	.69

"B" prefix designates less inverted nut.

For replacement nut use 105x4. See page 32.

Brass Products

Needle Valves

Male Pipe Double

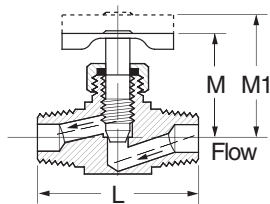
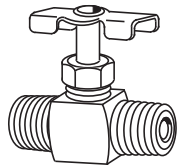

MALE PIPE THREAD	CATALOG NUMBER	L	M	M1
1/8	6810	1.38	.66	.80
1/4	6815	1.62	1.08	1.23

Male to Female Pipe

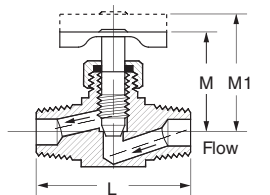
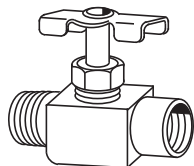

FEM. PIPE THREAD	MALE PIPE THREAD	CATALOG NUMBER	L	M	M1
1/8	1/8	6820	1.18	.88	1.03
1/4	1/4	6825	1.88	1.09	1.24

Female Pipe

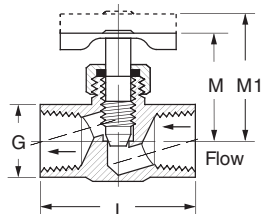
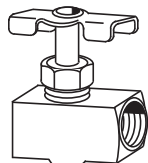

FEM. PIPE THREAD	CATALOG NUMBER	L	M	M1	G
1/8	6800	1.12	.88	1.03	.50
1/4	6805	1.62	1.11	1.26	.69

SAE 45° Flare Double

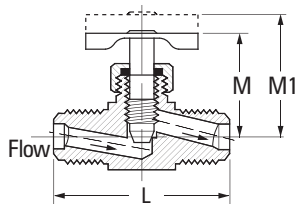

TUBE O.D.	CATALOG NUMBER	L	M	M1
1/4	6715	1.38	.87	1.03

Brass Products

Needle Valves

SAE 45° Flare Straightway

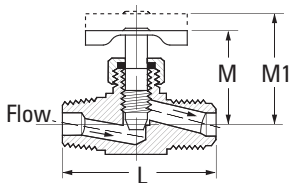

TUBE O.D.	MALE PIPE THREAD	CATALOG NUMBER	L	M	M1
1/4	1/8	530	1.31	.88	1.03
1/4	1/4	6700	1.38	.88	1.09
5/16	1/8	630	1.38	.95	1.13
5/16	1/4	695	1.44	.87	1.02
3/8	1/4	700	1.68	1.00	1.15

SAE 45° Flare Angle

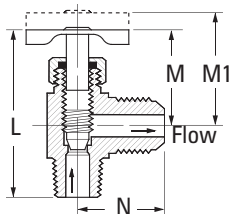
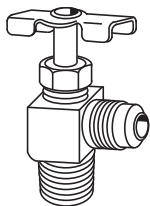

TUBE O.D.	MALE PIPE THREAD	CATALOG NUMBER	L	M	M1	N
1/4	1/8	320	1.54	.86	1.07	.68
5/16	1/8	325	1.59	.94	1.22	.88
5/16	1/4	6703	1.94	1.00	1.31	.90
3/8	1/4	330	1.84	.90	1.21	.97

Polyline Straightway

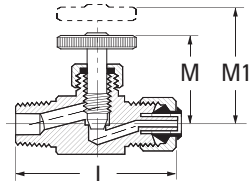
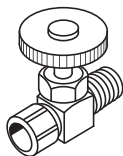

TUBE O.D.	MALE PIPE THREAD	CATALOG NUMBER	L	M	M1
1/4	1/8	A690P	1.19	.86	1.01
3/8	1/4	A6760P	1.50	1.18	1.33

Temperature Range:

-40°F to +150°F
with plastic sleeve.

For replacement Polyline nuts and sleeves,
see page 54.

Polyline Angle

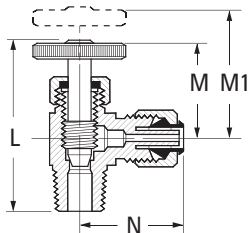
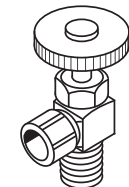

TUBE O.D.	MALE PIPE THREAD	CATALOG NUMBER	L	M	M1	N
1/4	1/8	A555P	1.50	.82	1.04	.48
1/4	1/4	A556P	1.70	.84	1.06	.56
3/8	1/4	A6860P	1.85	.99	1.44	.64

Temperature Range:

-40°F to +150°F
with plastic sleeve.

For replacement Polyline nuts and sleeves,
see page 54.

Brass Products

Drain Cocks

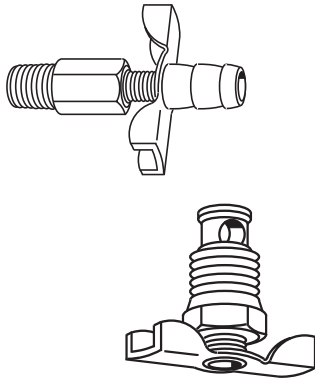

Drain Cocks and Drain Valves have been a specialty since 1919. Millions are in use. The original design has proved so efficient that it is still the leader with most original equipment manufacturers. The metal-to-metal seat requires only hand tightening to assure positive leak-proof performance.

Note:
For additional technical questions, contact Technical Support at 1-888-258-0222.

Refer to safety information regarding proper selection of tubing on page 1.

Typical Application:
Brass bodies/steel handles, except where noted.

Pressure:
150 psi maximum (does not include hose or plastic tubing.)

Used With:
Copper, aluminum, steel, hose and plastic tubing where applicable.

Temperature:
-65°F to +250°F (-53°C to +121°C). (Refer to tubing temperature range.)

Conformance:
Designed for automotive or industrial use. Not intended for natural gas, LPG, nuclear or aircraft applications, except as noted.

External Seat

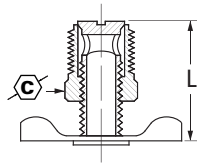
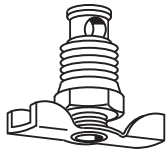

MALE PIPE THREAD	CATALOG NUMBER		L
1/8	135	7/16	.90
1/4	145	9/16	1.00
3/8	270	11/16	1.25
1/2	108	7/8	1.52

External Seat

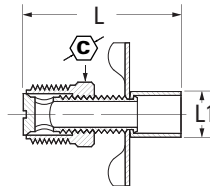
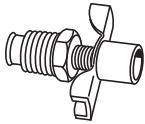

MALE PIPE THREAD	CATALOG NUMBER		L	L1
1/4	6788	9/16	1.56	.44

Internal Seat

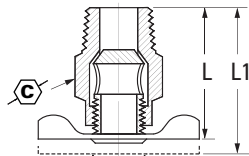
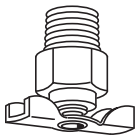

MALE PIPE THREAD	CATALOG NUMBER		L	L1
1/8	130	17/32	1.15	1.30
1/4	140	5/8	1.32	1.50
1/4	190	9/16	1.25	1.41
3/8	230	11/16	1.34	1.50

Internal Seat

(Long)

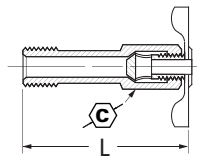
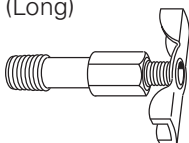

MALE PIPE THREAD	CATALOG NUMBER		L
1/8	185	7/16	1.72

Brass Products

Drain Cocks

Internal Seat

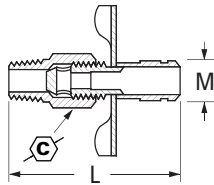
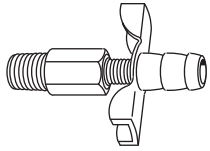

MALE PIPE THREAD	CATALOG NUMBER		L	M
1/8	6783	13/32	1.63	.344

Internal Seat Drain Valve

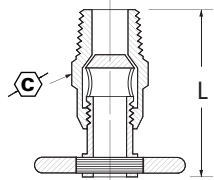
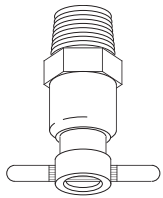

MALE PIPE THREAD	CATALOG NUMBER		L
1/8	1424A	1/2	1.219
1/4	1425A	9/16	1.313
3/8	1426A	11/16	1.688

Air Vent

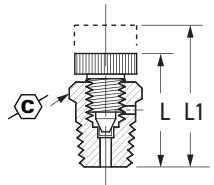

MALE PIPE THREAD	CATALOG NUMBER		L	L1
1/8	705	13/32	.78	.88

Set screw has 10-32 national fine thread.

Angle Bib Drain

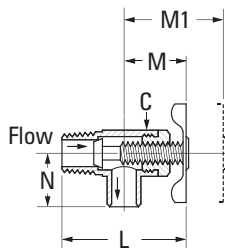
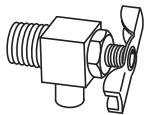

MALE PIPE THREAD	CATALOG NUMBER	SQUARE C	L	M	M1	N
1/8	150	7/16	1.12	.57	.95	.38
1/4	120	5/8	1.76	.94	1.50	.66

Angle Bib Drain

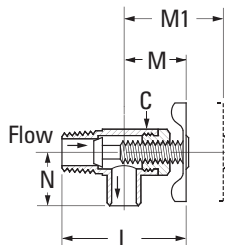
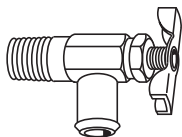

HOSE I.D.	MALE PIPE THREAD	CATALOG NUMBER	SQUARE C	L	M	M1	N
3/8	1/4	6660	9/16	1.33	.62	1.01	.66

Brass Products

Drain Cocks

Hose to Pipe

(Steel Body)

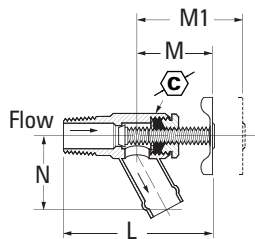
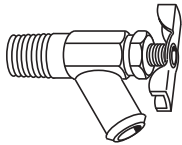

HOSE SIZE	MALE PIPE THREAD	CATALOG NUMBER		L	M	M1	N
5/8	3/8	211273A	11/16	2.85	1.41	1.91	1.30

Hose to Pipe

(Steel Body)

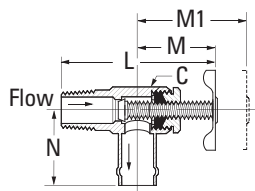
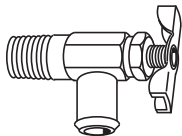

HOSE I.D.	MALE PIPE THREAD	CATALOG NUMBER	SQUARE C	L	M	M1	N
5/8	3/8	211280A	11/16	2.85	1.10	1.47	1.19

Pipe to Hose Shut-Off

(Brass Body)

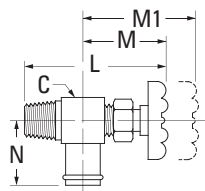
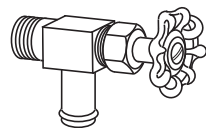

HOSE SIZE	MALE PIPE THREAD	CATALOG NUMBER	SQUARE C	L	M	M1	N
3/8	3/8	1422	3/4	2.93	1.78	2.25	1.12
5/8	3/8	1423	13/16	2.93	1.81	2.25	1.35
3/4	3/8	1433	15/16	3.00	1.81	2.25	1.35
3/4	1/2	1451	15/16	3.12	1.93	2.25	1.35

Red color coded aluminum handle.
Handle Catalog Number 1427.

Gasoline Shut-Off with Screen Filter

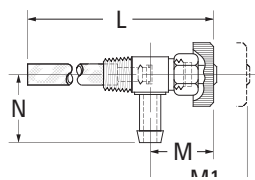
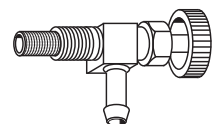

HOSE SIZE	MALE PIPE THREAD	CATALOG NUMBER	L	M	M1	N
1/4	1/8	6600	3.36	.80	.97	.84

Air Tank Drain Valve

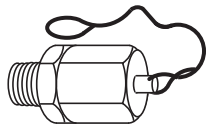

Pull cable sideways.

MALE PIPE THREAD	CABLE LENGTH	CATALOG NUMBER
1/4	7"	1421-7
1/4	18"	1421-18
1/4	24"	1421-24
1/4	32"	1421-32
1/4	60"	1421-60
1/4	60"	1421-60A*

*No loop on cable end.

Brass Products

Truck Valves

Typical Application:
Used extensively in the trucking industry for cooling and fuel line applications.

Material:
Forged brass bodies, steel handles.

Pressure Range:
200 psi maximum.

Temperature:
-40°F to +250°F
(-40°C to +121°C)

Conformance:
Designed for trucking use. Not intended for natural gas, LPG, nuclear or aircraft applications.

Note:
Buna-N o-ring sealed;

Truck Valve

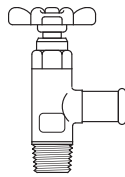

HOSE I.D.	PIPE THREAD	CATALOG NUMBER
5/8	1/2	7502

Truck Valve

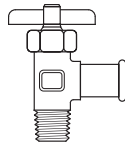

HOSE I.D.	PIPE THREAD	CATALOG NUMBER
5/8	3/8	7504

Truck Valve

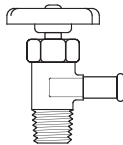

HOSE I.D.	PIPE THREAD	CATALOG NUMBER
3/8	3/8	7506

Truck Valve

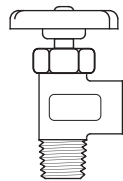

FEMALE PIPE THREAD	MALE PIPE THREAD	CATALOG NUMBER
1/2	1/2	7508

Truck Valve

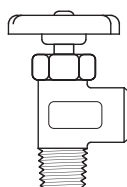

FEMALE PIPE THREAD	MALE PIPE THREAD	CATALOG NUMBER
3/8	3/8	7509

Brass Products

Plastic Drain Cocks

Material:
Nylon 6 Fiber Reinforced.

Pressure Range:
Up to 25 psi.

Used With
Automotive Radiators:

Temperature:
-50°F to +180°F
(-46°C to +82°C)

Conformance:
Designed for automotive use. Not intended for natural gas, LPG, nuclear or aircraft applications.

M10x1.25

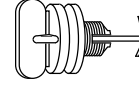

Ford

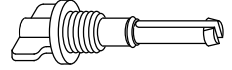

THREAD	CATALOG NUMBER
M10x1.25	118

THREAD	CATALOG NUMBER
M14x2.0	124

Chrysler

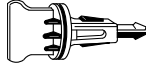

M12x1.25



M12x1.5



Chrysler

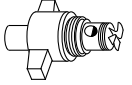

THREAD	CATALOG NUMBER
Captive	110

THREAD	CATALOG NUMBER
M12x1.25	114

THREAD	CATALOG NUMBER
M12x1.5	119

THREAD	CATALOG NUMBER
5/8-18	125

GM

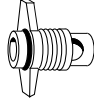

M14x1.25

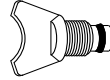

Ford and Mazda

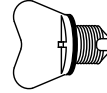

Chrysler

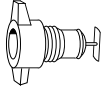

THREAD	CATALOG NUMBER
Oversized	111

THREAD	CATALOG NUMBER
M14x1.25	115

THREAD	CATALOG NUMBER
M10x1.25	121

THREAD	CATALOG NUMBER
5/8-18	126

Ford (Long)

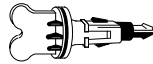

M10x1.25

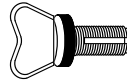

M14x2.0

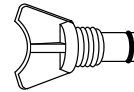

GM

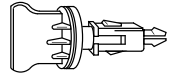

THREAD	CATALOG NUMBER
Captive	112

THREAD	CATALOG NUMBER
M10x1.25	116

THREAD	CATALOG NUMBER
M14x2.0	122

THREAD	CATALOG NUMBER
Captive	127

Ford (Short)

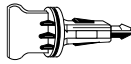

M14x1.25

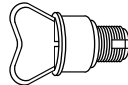

Chrysler

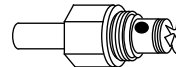

GM

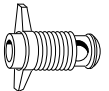

THREAD	CATALOG NUMBER
Captive	113

THREAD	CATALOG NUMBER
M14x1.25	117

THREAD	CATALOG NUMBER
5/8-18	123

THREAD	CATALOG NUMBER
1/2-18	128

Brass Products

Ground Plug & Multiple Shut-Offs

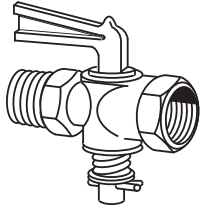
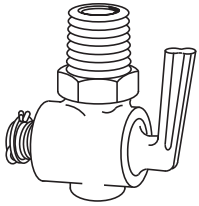

Pressure Range:
30 psi working pressure, except where noted.

Used With:
Copper, aluminum, steel and plastic tubing where applicable.

Material:
Brass bodies and handles.

Temperature:
-65°F to +250°F (-53°C to +121°C) with metal tubing. For use with plastic tubing, refer to the tubing temperature range.

Note:
For additional technical questions, contact Technical Support at 1-888-258-0222.

 Refer to safety information regarding proper selection of tubing on page 1.

Conformance:
Designed for automotive or industrial use. Not intended for natural gas, LPG, nuclear or aircraft applications, except as noted.

Ordering Information:
Order valve body, nut and sleeves by catalog number. Order valves with Selfalign nuts and sleeves by adding suffix "S". Example: A694S. Order valves less nut and sleeve by adding prefix "B". Example: B694.

Note:
Ground Plug Drains and Shut-Offs use a universal lubricant satisfactory for use with most common fluids. However the lubricant may wash out at higher pressures or with some exotic fluids.

Draincock

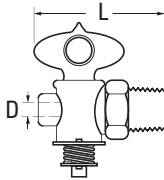

Ratings:
Valves are designed to hold air pressure of 125 psi with one 1/4" bubble in 5 seconds permissible key leakage.

MALE PIPE THREAD	CATALOG NUMBER	D	L
1/4	W15310	.188	1.56

Ground Plug Drain

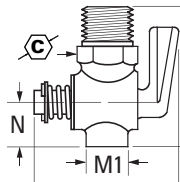
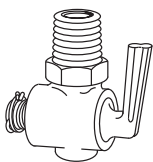

MALE PIPE THD.	CATALOG NUMBER		L	N	M	M1
1/8	6891	9/16	1.93	.75	1.63	.87
1/4	6892	5/8	1.62	.75	1.75	1.03
3/8	6893	11/16	1.72	1.00	2.31	1.22

SAE 45° Flare Double

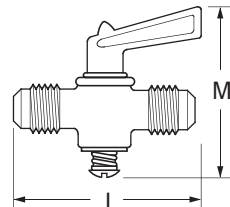
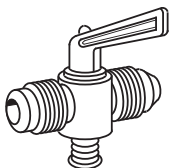

TUBE O.D.	CATALOG NUMBER	L	M
1/4	6719	1.88	1.88
5/16	6724	1.88	1.88
3/8	6729	2.00	1.88

Brass Products

Ground Plug & Multiple Shut-Offs

SAE 45° Flare Straightway

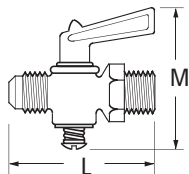
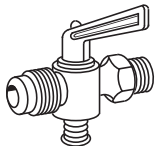

TUBE O.D.	MALE PIPE THREAD	CATALOG NUMBER	L	M
1/4	1/8	537	2.00	1.88
5/16	1/8	632	2.03	1.88
5/16	1/4	702	2.03	1.88
3/8	1/4	703	2.06	1.88

Compression Double

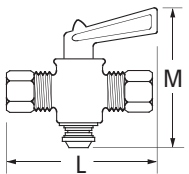
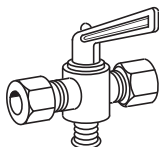

TUBE O.D.	CATALOG NUMBER	L	M
1/4	A6769	2.12	1.88
1/4	A6769S	2.12	1.88
5/16	A6774	2.19	1.88
3/8	A6779	2.25	1.88
3/8	A6779S	2.25	1.88

"S" suffix designates Selfalign with Nuts and Sleeves.

Compression Straightway

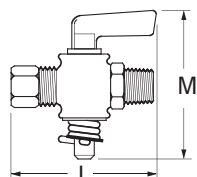
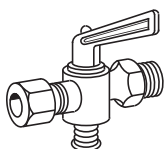

TUBE O.D.	MALE PIPE THREAD	CATALOG NUMBER	L	M
1/4	1/8	A694	2.19	1.88
1/4	1/8	A694S	2.19	1.88
1/4	1/4	A6754	2.19	1.88
1/4	1/4	A6754S	2.19	1.88
5/16	1/8	A664	2.19	1.88
5/16	1/4	A6759	2.25	1.88
3/8	1/4	A6764	2.38	1.88
3/8	1/4	A6764S	2.38	1.88

"S" suffix designates Selfalign with Nuts and Sleeves.

Male to Female Pipe

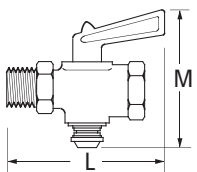
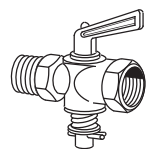

MALE PIPE THREAD	FEMALE PIPE THREAD	CATALOG NUMBER	L	M
1/8	1/8	6824	2.00	1.88
1/4	1/4	6829	2.12	1.88

Truck Shut Off Male to Female Pipe

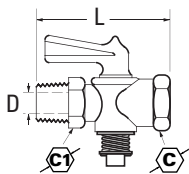
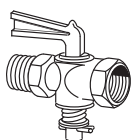

MALE PIPE THREAD	FEMALE PIPE THREAD	CATALOG NUMBER			L	D
1/4	1/4	W20332	5/8	3/4	1.81	.218

Ratings:

Valves are designed to hold air pressure of 125 psi with one 1/4" bubble in 5 seconds permissible key leakage.

Brass Products

Ground Plug & Multiple Shut-Offs

Marine Shut Off Male to Female Pipe

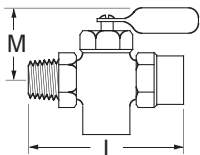
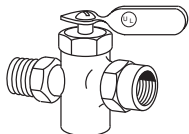

UL Listed for Marine Fuel.

MALE PIPE THD.	FEMALE PIPE THD.	CATALOG NUMBER	L	M
1/4	1/4	6828	2.22	1.97

Female Pipe Double

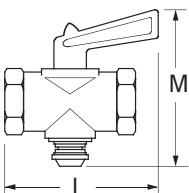
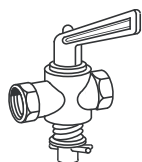

FEMALE PIPE THREAD	CATALOG NUMBER	L	M
1/8	6804	1.46	1.88
1/4	6809	1.70	1.88

3 Way Shut-Off

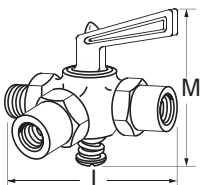
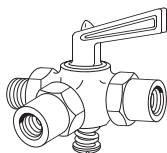

MALE PIPE THD.	FEMALE PIPE THD.	CATALOG NUMBER	L	M
1/8	1/8	6737	2.12	1.88

3 Way Multiple Shut-Off

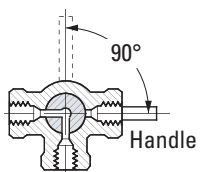
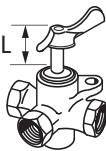

FEMALE PIPE THREAD	L STEM	CATALOG NUMBER
1/4	1.37	6749
3/8	1.37	6709

Replacement Handle:

Catalog Number 6746. Includes Screw.
Click-washer assembly positively holds valve in desired position and gives a pronounced click.

4 Way Multiple Shut-Off

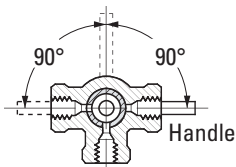
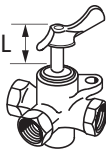

FEMALE PIPE THREAD	L STEM	CATALOG NUMBER
1/4	1.37	6747
1/4	2.37	6748
3/8	1.37	6707
3/8	2.37	6708

Replacement Handle:

Catalog Number 6746. Includes Screw.
Click-washer assembly positively holds valve in desired position and gives a pronounced click.

Brass Products

Brass Ball Valves

Forged Body Brass 3-Way Ball Valve

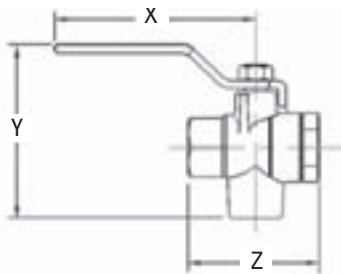

Features/Benefits

- Forged brass body
- Blowout proof stem
- Chrome plated ball
- Double o-ring stem seal - never needs tightening
- Floating ball design
- Standard steel handle

PART NUMBER	CONNECTIONS	SIZE	X	Y	Z
FF90587-04	F x F x F NPT	1/4"	3.20	3.12	2.25
FF90587-06	F x F x F NPT	3/8"	3.20	3.12	2.25
FF90587-08	F x F x F NPT	1/2"	3.20	3.12	2.25

Applications

- Vacuum service
- Industrial service
- Machine/engine coolant
- Center off position
- Diverter valve

Service

- Working pressure: 500 psig bottom inlet @ 70°F; 100 psig side inlets
- Temperature range: -40°F + 300°F
- Orifice diameters:
1/4" = .440"
3/8" = .500"
1/2" = .500"
- Vacuum rating: Full
- For: Water, oils and gases

Note: Not steam rated.

Forged Body Brass Ball Valve

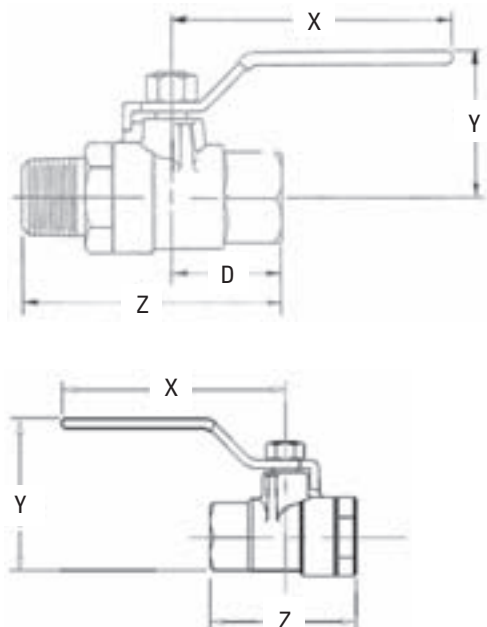

Features/Benefits

- Forged brass body
- Blowout proof stem
- Chrome plated brass ball
- Double o-ring stem seal
- Tamper proof design
- Floating ball design
- Standard steel handle
- 1/4 turn - full on/off

PART NUMBER	CONNECTIONS	SIZE	X	Y	Z	D
FF90588-04	M x F NPT	1/4"	3.70	2.38	2.75	1.13
FF90588-06	M x F NPT	3/8"	3.70	2.38	2.75	1.13
FF90588-08	M x F NPT	1/2"	3.70	2.38	2.75	1.13
FF90588-12	M x F NPT	3/4"	3.80	2.72	3.40	1.43
FF90588-16	M x F NPT	1"	4.50	3.00	4.00	1.71
FF90588-20	M x F NPT	1-1/4"	6.22	3.01	4.05	1.83
FF90588-24	M x F NPT	1-1/2"	6.22	3.24	4.35	2.01
FF90588-32	M x F NPT	2"	6.22	3.52	5.13	2.38

PART NUMBER	CONNECTIONS	SIZE	X	Y	Z
FF90589-04	F x F x F NPT	1/4"	3.70	2.38	2.25
FF90589-06	F x F x F NPT	3/8"	3.70	2.38	2.25
FF90589-08	F x F x F NPT	1/2"	3.70	2.38	2.25
FF90589-12	F x F x F NPT	3/4"	3.80	2.72	2.98
FF90589-16	F x F x F NPT	1"	4.50	3.00	3.34
FF90589-20	F x F x F NPT	1-1/4"	6.20	3.78	3.65
FF90589-24	F x F x F NPT	1-1/2"	6.20	4.15	4.00
FF90589-32	F x F x F NPT	2"	6.20	4.75	4.76

Applications

- Vacuum service
- Industrial service
- Machine/engine coolant
- Water service
- Fuel tank - gasoline/ diesel

Service

- Working pressure: 600 psig WOG @ 70°F
- Temperature range: -40°F + 300°F
- Orifice diameters:
1/4" = .44"; 3/8" = .50";
1/2" = .50"; 3/4" = .69;
1" = .88, 1-1/4" = 1.18,
1-1/2" = 1.57, 2" = 1.89
- Vacuum rating: Full
- For: Water, oils and gases

Note: Not steam rated.

Brass Products

Brass Ball Valves

Brass Instrumentation 3-Way Ball Valve

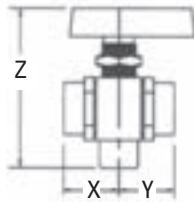

PART NUMBER	CONNECTIONS	SIZE	X	Y	Z
FF90597-02	F x F NPT	1/8"	0.92	0.92	2.12
FF90597-04	F x F NPT	1/4"	0.92	0.92	2.12
FF90597-06	F x F NPT	3/8"	1.10	1.10	2.59
FF90597-08	F x F NPT	1/2"	1.19	1.19	2.59
FF90598-02	Compression	1/8"	0.92	0.92	2.12
FF90598-04	Compression	1/4"	0.92	0.92	2.12
FF90598-06	Compression	3/8"	1.10	1.10	2.59
FF90598-08	Compression	1/2"	1.19	1.19	2.59

Features/Benefits

- Brass bar stock body
- Blowout proof stem
- Nickel plated ball
- Viton stem seal
- Double o-ring stem seal - never needs tightening
- Metal retainer seal
- Center off position
- Seals: Ball seats = teflon, stem seals = 2 o-rings (Viton & Buna-n)

Applications

- Vacuum service
- Industrial service
- Center off position
- Water service
- Panel mounting

Services

- Working pressure:
1/8" & 1/4" = 1500 psig @ 70°F
3/8" & 1/2" = 1,000 psig @ 70°F (side port inlet) 1000 psig (bottom port inlet)
- Temperature range:
-40°F + 300°F
- Orifice diameters: 1/8" & 1/4" = .250" 3/8" & 1/2" = .340"
- Vacuum rating: Full
- For: Water, oils and gases
- Panel mount hole size:
9/16" ID

Note: Not steam rated.

Brass Products

Brass Ball Valves

Brass Instrumentation 2-Way 90 Degree Ball Valve

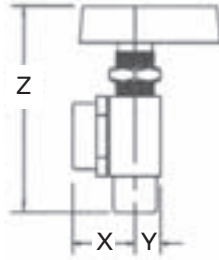

PART NUMBER	CONNECTIONS	SIZE	X	Y	Z
FF90595-02	F x F NPT	1/8"	0.92	0.38	2.12
FF90595-04	F x F NPT	1/4"	0.92	0.38	2.12
FF90595-06	F x F NPT	3/8"	1.10	0.75	2.59
FF90595-08	F x F NPT	1/2"	1.19	0.75	2.59
FF90596-02	Compression	1/8"	0.92	0.38	2.12
FF90596-04	Compression	1/4"	0.92	0.38	2.12
FF90596-06	Compression	3/8"	1.10	0.75	2.59
FF90596-08	Compression	1/2"	1.19	0.75	2.59

Features/Benefits

- Brass bar stock body
- Blowout proof stem
- Nickel plated brass ball
- Double o-ring stem seal
- Metal retainer seal
- 90° configuration eliminates fittings
- Seals: Ball seats = teflon, stem seals = 2 o-rings (Viton & Buna-n)

Applications

- Vacuum service
- Industrial service
- Water service
- Panel mount

Service

- Working pressure: 1/8" & 1/4" = 1500 psig @ 70°F 3/8" & 1/2" = 1,000 psig @ 70°F (side port inlet) 1000 psig (bottom port inlet)
- Temperature range: -40°F + 300°F
- Orifice diameters: 1/8" & 1/4" = .250" 3/8" & 1/2" = .340"
- Vacuum rating: Full
- For: Water, oils and gases
- Panel mount hole size: 9/16" ID

Note: Not steam rated.

Brass Products

Brass Ball Valves

Brass Mini-Instrumentation 2-Way 90 Ball Valve

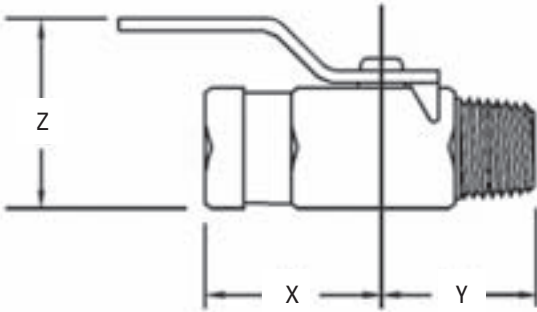

Features/Benefits

- Brass bar stock body
- Blowout proof stem
- Nickel plated ball
- Viton stem seal
- Standard metal handle
- Floating ball design
- 1/4 turn - full on/off

PART NUMBER	CONNECTIONS	SIZE	X	Y	Z
FF90590-02	M x F NPT	1/8"	1.13	0.75	1.25
FF90590-04	M x F NPT	1/4"	1.13	0.81	1.25
FF90591-02	M x M NPT	1/8"	1.13	0.75	1.25
FF90591-04	M x M NPT	1/4"	1.13	0.81	1.25
FF90592-02	F x F NPT	1/8"	1.13	0.75	1.25
FF90592-04	F x F NPT	1/4"	1.13	0.85	1.25

Applications

- Vacuum service
- Industrial service
- Coolant service
- Water service
- Compact shut off installations
- Low cost instrumentation
- Hose shut off

Service

- Working pressure: 1,000 psig WOG @ 70°F
- Temperature range: -40°F + 300°F
- Orifice diameters: 1/8" & 1/4" = .250"
- Vacuum rating: Full
- For: Water, oils and gases

Note: Not steam rated.

Brass Instrumentation 2-Way Ball Valve

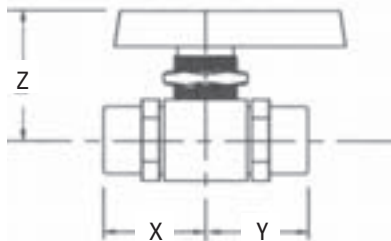

Features/Benefits

- Brass bar stock body
- Blowout proof stem
- Nickel plated ball
- Viton stem seal
- Metal retainer seal
- Seals: Ball seats = teflon, stem seals = 2 o-rings (Viton & Buna-n)

PART NUMBER	CONNECTIONS	SIZE	X	Y	Z
FF90593-02	F x F NPT	1/8"	0.92	0.92	1.25
FF90593-04	F x F NPT	1/4"	0.92	0.92	1.25
FF90593-06	F x F NPT	3/8"	1.10	1.10	1.42
FF90593-08	F x F NPT	1/2"	1.19	1.90	1.42
FF90594-02	Compression	1/8"	0.92	0.92	1.25
FF90594-04	Compression	1/4"	0.92	0.92	1.25
FF90594-06	Compression	3/8"	1.10	1.10	1.42
FF90594-08	Compression	1/2"	1.46	1.46	1.42

Applications

- Vacuum service
- Industrial service
- Water service
- Panel mounting

Service

- Working pressure: 1/8" & 1/4" = 1500 psig @ 70°F 3/8" & 1/2" = 1000 psig @ 70°F

Service (cont)

- Temperature range: -40°F + 300°F
- Orifice diameters: 1/8" & 1/4" = .250" 3/8" & 1/2" = .375"
- Vacuum rating: Full
- For: Water, oils and gases
- Panel mount hole size: 9/16" ID

Note: Not steam rated.

Brass Products

Special Adapters

Turbocharger Discharge Connector

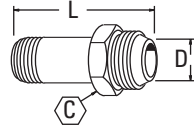

MALE STRAIGHT THREAD	MALE PIPE THREAD	CATALOG NUMBER		D	L
1 AC-811	3/4	1408	1-3/8	.719	3.25
30° Flare Tube					

Wiper Tee

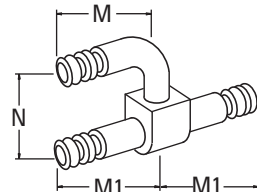

HOSE I.D.	CATALOG NUMBER	M	M1	N
1/4	1410	.88	1.00	1.02

Transmission Oil Coolant Line Adapter

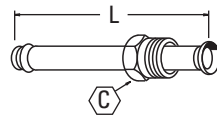

TUBE O.D.	INVERTED NUT	CATALOG NUMBER		L
5/16	5/16	1428	1/2	4.50
3/8	3/8	1429	5/8	4.50

Truck Oil Line Extended SAE 45° Flare Fitting

(Replaces Roto Master No. 10-35)

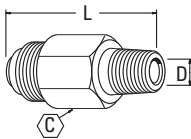

SAE 45° TUBE SIZE	MALE PIPE THREAD	CATALOG NUMBER		D	L
3/8	1/4	1432	5/8	.282	1.90

Brass Products

Special Adapters

 Refer to safety information regarding proper selection of tubing on page 1.

Ford Transmission Elbow

Includes O-Rings.

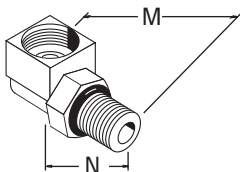



TUBE O.D.	STRAIGHT MALE PIPE THREAD	CATALOG NUMBER	M	N
5/16-28	1/8-27	1437	.94	.47

Power Steering Male 37° JIC Adapter

(Brass)

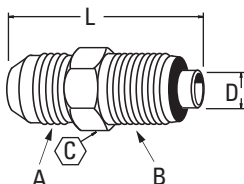
Includes O-Rings.



TUBE O.D.	THREAD A	THREAD B	CATALOG NUMBER		D	L
1/4	7/16-20	9/16-18	1440	9/16	.172	1.42
3/8	9/16-18	5/8-18	1439	5/8	.266	1.49

Metric Power Steering Adapter

Includes O-Rings.

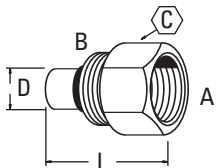

O.D.	INVERTED TUBE A	THREAD B	THREAD NUMBER	CATALOG C		L
3/8	5/8-18	M14x1.5	1445	3/4	.266	1.18
3/8	5/8-18	M16x1.5	1446	3/4	.266	1.18
3/8	5/8-18	M18x1.5	1447	3/4	.266	1.18

Ford Power Steering Fitting

Includes O-Rings.

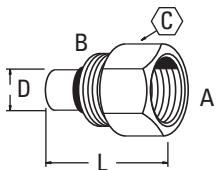



INVERTED THREAD A	MALE O-RING B	CATALOG NUMBER		D	L
5/8-18	11/16-18	1444	3/4	.266	1.38

Restriction Pipe Adapter

(With .0625 Orifice)

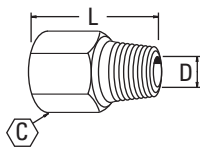
NOTE: Other orifice sizes available (special order only).



MALE PIPE THREAD	FEMALE PIPE THREAD	CATALOG NUMBER		D	L
1/8	1/8*	1512	1/2	.0625	.75

* PTF short thread.

Brass Products

Special Adapters

 Refer to safety information regarding proper selection of tubing on page 1.

Carburetor to Fuel Line Adapter

(Ford)

For use with 59x4

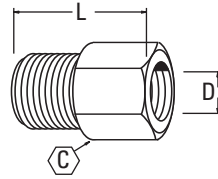

TUBE O.D.	THREAD SIZE	MALE PIPE THREAD	CATALOG NUMBER		D	L
1/4	1/2-20	1/8	1513	9/16	.219	1.06

Fuel Line Adapter

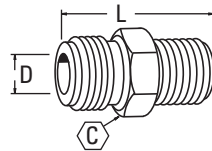

INVERTED MALE	MALE PIPE THREAD	CATALOG NUMBER		D	L
1/2-20	1/8	1514	1/2	.219	.90

AC Type Adapter

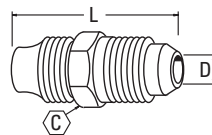

TUBE O.D.	S.A.E. 45° TUBE SIZE	CATALOG NUMBER		D	L
1/4	1/4	1521	7/16	.188	1.09

Adapter SAE 45° Flare to Inv. Flare

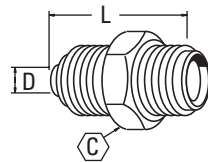

SAE 45° TUBE SIZE	INVERTED MALE	CATALOG NUMBER		D	L
1/4	3/16	1518	7/16	.189	1.03
1/4	1/4	1522	7/16	.189	1.03
3/8	5/16	1553	5/8	.234	1.34
3/8	3/8	1563	5/8	.282	1.38
3/8	7/16	1554	11/16	.282	1.40

Carburetion Inlet

(Steel)

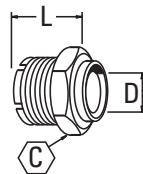

INV. SEAT	MALE THREAD	CATALOG NUMBER		D	L
3/8	7/8-20	1596	1	.281	.91

Brass Products

Special Adapters

 Refer to safety information regarding proper selection of tubing on page 1.

Special Steel Bushing

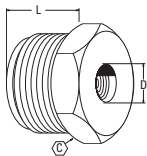

MALE THREAD	FEMALE PIPE THREAD	CATALOG NUMBER		D	L
1-1/16-16UN-2A	1/8	7977	1-1/8	.328	.94
1-1/16-16UN-2A	3/8	7978	1-1/8	.562	.94

Male JIC 37° Flare to Metric O-Ring Port Adapter

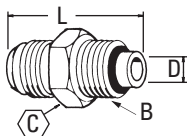

Steel (with o-ring)

Application:

GM power steering with Saginaw steering and rack and pinion steering systems.

Includes O-Ring.

TUBE O.D.	THREAD B	CATALOG NUMBER		D	L
3/8	M14x1.5	M41157x6x14	3/4	.266	1.62
3/8	M16x1.5	M41157x6x16	3/4	.266	1.62
3/8	M18x1.5	M41157x6x18	3/4	.266	1.62

Ford Nut

For use with 1513 (Nut similar to 59x4 for 3/16" tube, use 6100x3)

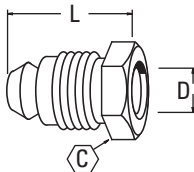

TUBE SIZE	THREAD SIZE	CATALOG NUMBER		D	L
1/4	1/2-20	59x4	1/2	.258	.64

Transmission Coolant Line Adapters (GMC)

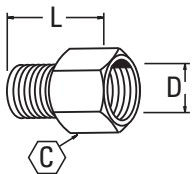

INV. FEMALE	INV. MALE	CATALOG NUMBER		D	L
3/8 (5/8-18)	5/16 (1/2-20)	7915	3/4	.250	1.00
5/16 (1/2-20)	3/8 (5/8-18)	7916	5/8	.220	.94

AC8111 (Steel) Connector

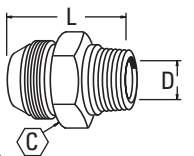

Application:

PTT Thread 30° tube to male pipe adapter for diesel engines.

TUBE SIZE	MALE PIPE	CATALOG NUMBER		D	L
1 (1-5/16-14)	1	C9200	1-3/8	.844	2.04
1 (1-5/16-14)	3/4	C9240	1-3/8	.800	1.84

Brass Products

Hydraulic Brake Products

 Refer to safety information regarding proper selection of tubing on page 1.

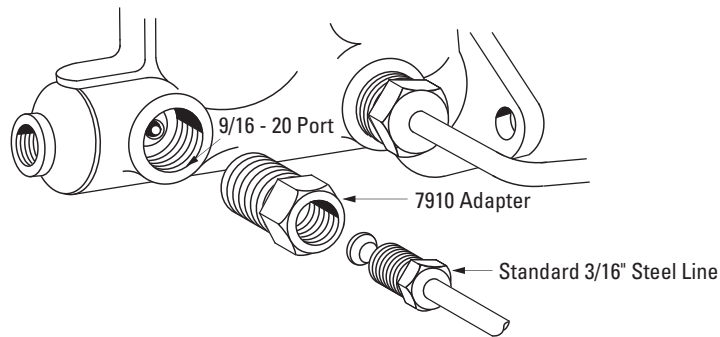

Adapters can be used to adapt standard steel brake lines to the different size ports used in dual master cylinders. The tube O.D. is the outside diameter of

the steel brake line. Thread size can be determined by measuring with a U.S. or Metric screw pitch gauge. See pages 10 to 14.

STANDARD INVERTED FLARE TUBE AND THREAD SIZE

Tube Size	1/8	3/16	1/4	5/16	3/8	7/16	1/2	5/8	3/4	7/8	1
Thread Size	5/16-28	3/8-24	7/16-24	1/2-20	5/8-18	11/16-18	3/4-18	7/8-18	1-1/16-16	1-3/16-16	1-5/16-16

Standard Tube Nut

(Steel)

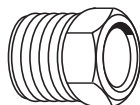

TUBE SIZE	CATALOG NUMBER
1/8	105x2
3/16	105x3
1/4	105x4
5/16	105x5
3/8	105x6
3/8	105x6x7*
7/16	105x7
1/2	105x8
5/8	105x10
3/4	105x12
7/8	105x14
1	105x16

*11/16-18 Thread

Long Tube Nut

(Steel)

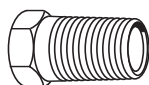

TUBE O.D.	THREAD SIZE	CATALOG NUMBER
3/16	3/8-24	7896x3
1/4	7/16-24	7896x4

Dual Master Cylinder Adapter

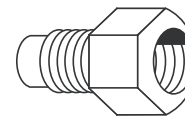

INVERTED MALE THREAD	INVERTED FEMALE THREAD	CATALOG NUMBER
(Exceptions Noted)	(Exceptions Noted)	
3/16 (9/16-18)	3/16	7911
3/16 (9/16-18)	3/16 (1/2-20)	7913
3/16 (9/16-20)	3/16	7910
3/16	1/4	7828
1/4	3/16	7818
7/16-20	1/4	7732*
1/4 (9/16-18)	1/4	7908
1/4	5/16†	7917
5/16	3/16	7817*
5/16	3/16	7909
5/16	3/16 (9/16-18)	7912
5/16	1/4	7727*
5/16	1/4	7829
5/16	5/16	1074*
5/16	3/8	7915
3/8 NPTF	5/16	7771
3/8	5/16	7916

†Seat may be used for 3/16", 1/4", 5/16" Tube Connection with 1/2-20 Thread.

*Seals On Hex Face (E)

Dual Master Cylinder Adapter

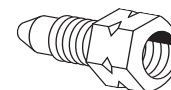

BUBBLE FLARE MALE THREAD	INVERTED FEMALE THREAD	CATALOG NUMBER
3/16	3/16	1441
5/16	3/16	7897

Brass Products

Hydraulic Brake Products

Towed Trailer Brake Tee

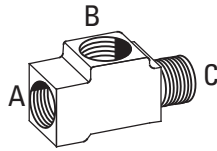

INVERTED SEAT A	B	MALE THREAD C	CATALOG NUMBER
3/16 (3/8-24)	3/16 (3/8-24)	3/16 inv. (3/8-24)	7900
3/16 (1/2-20)	3/16 (3/8-24)	1/2-20 inv.	7906
3/16 (9/16-18)	3/16 (3/8-24)	3/16 inv. (9/16-18)	7933
3/16 (9/16-20)	3/16 (3/8-24)	3/16 inv. (9/16-20)	7905
3/16 (7/16-24)	3/16 (3/8-24)	1/4 inv. (7/16-24)	7914
1/4 (7/16-24)	3/16 (3/8-24)	1/4 inv. (7/16-24)	7901
1/4 (9/16-18)	3/16 (3/8-24)	1/4 inv. (9/16-18)	7904
1/4 (7/16-24)	1/4 (7/16-24)	1/4 inv. (7/16-24)	7898

Metric Hydraulic Brake Products

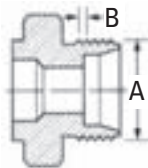

How to Measure Metric Threads

Metric threads are measured and specified by the thread diameter in millimeters and the pitch in millimeters per thread. If dimension "A" is

22mm and dimension "B" (crest to crest distance) is 1.5mm, then the metric thread size is M22 x 1.5.

Metric Adapter

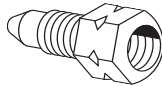

BUBBLE MALE THREAD	TUBE O.D./ FEMALE THREAD	CATALOG NUMBER
M10 x 1.0	3/16 (3/8-24)	1442*
M11 x 1.5	3/16 (M10 x 1.0)	7935**
M12 x 1.0	3/16 (M10 x 1.0)	7936**
M13 x 1.5	3/16 (M10 x 1.0)	7937**

*Use S Series Brake Lines. (standard flare)

**Use SJ Series Steel Brake Lines. (standard flare)

Metric Adapter

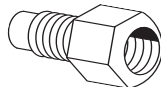

INVERTED MALE THREAD	TUBE O.D./ FEMALE THREAD	CATALOG NUMBER
M10 x 1.0	3/16 (3/8-24)	1443*

*Use S Series Brake Lines. (standard flare)

**Use SJ Series Steel Brake Lines. (standard flare)

Strap Tee Assembly

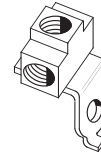

INV. SEAT	BOLT HOLE	CATALOG NUMBER
3/16 (3)	11/32	7812
1/4 (3)	11/32	7765*

*Has flat strap

Brake Adapter



INV. SEAT	BOLT HOLE	CATALOG NUMBER
1/4	19/32	7709

Rear Axle Tee

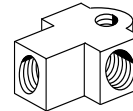

INV. SEAT	BOLT HOLE	HOSE END PORT	CATALOG NUMBER
3/16 (2)	9/32	3/8-24	7805

Adapter Standard to Metric Bubble

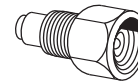

FEMALE STD. FL. SEAT	MALE BUBBLE FL. TUBE	CATALOG NUMBER
3/16" (3/8-24 thread)	3/16" (10x1.25 thread)	7970

Used on Fiat applications when converting 3/16" (3/8-24) inverted flare brake lines to 3/16" (10x1.25) metric thread bubble flare.

Adapter Standard to Metric Bubble

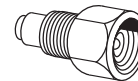

FEMALE INV. FL. SEAT	MALE METRIC BUBBLE FL. THREAD	CATALOG NUMBER
3/16" (3/8-24 thread)	13x1.5	7972
3/16" (3/8-24 thread)	12x1.0	7974

Used on Fiat applications when converting 3/16" (3/8-24) inverted flare brake lines to 3/16" (10x1.25) metric thread bubble flare.

Brass Products

Hydraulic Brake Products

Brake Line Unions for Domestic and Imported Vehicles

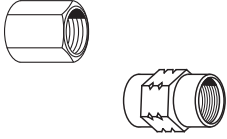

DESCRIPTION	CATALOG NO.
3/16" line to 3/16" line (3/8–24 thread), (Standard Flare) 'S' Series	302x3
1/4" line to 1/4" (7/16–24 thread), (Standard Flare) 'S' Series	302x4
5/16" line to 5/16" line (1/2–20 thread), (Standard Flare) 'S' Series	302x5
3/8" line to 3/8" line (5/8–18 thread), (Standard Flare) 'S' Series	302x6
British line to British line (3/8–24 thread), (ISO flare) 'SB' Series (Steel)	7940
European line to European line (10–1.0mm thread), (Bubble Flare) 'SC' Series (Steel)	7941
Japanese line to Japanese line (10–1.0mm thread), (Standard Flare) 'SJ' Series (Brass)	7934A
For joining Edelmann 6300 series metric thread bubble flare 3/16" brake lines (10-1.0mm thread) (brass)	7975

Plastic Products

Molded Compression Tube Products

 Refer to safety information regarding proper selection of tubing on page 1.



Molded Compression Tube Products

Sizes:

Available in sizes 1/8" through 3/4" tube OD (7/8" tube OD and metric tube sizes available on request from Technical Support at 1-888-258-0222.

Materials:

Molded as standard in two materials: nylon and polypropylene

Nylon characteristics:

- good resistance to organic solvents, oils, and gasoline
- excellent impact resistance
- tolerant to repeated steam for wash down and longtime weathering
- F.D.A. and N.S.F. listed
- operating temperatures -40°F to 200°F (-40°C to 93°C) – not to exceed temperature specification of tubing

Polypropylene characteristics:

- good chemical and corrosion resistance
- opaque
- 20% glass filled
- N.S.F. listed
- operating temperatures -30°F to 200°F (-34°C to 93°C) – not to exceed temperature specification of tubing

Available on request in two materials: Celcon®* (acetal copolymer) or KYNAR®** (polyvinylidene fluoride)

Styles:

Available in two standard styles:

Ferrule Nut (integral nut and sleeve for soft tubing to 50 PSI♦)

- features ferrule and nut molded as a single part, eliminating the need for a two-piece assembly

Gripper Nut with separate plastic sleeve (for sure-grip with plastic tubing up to 220 PSI♦)

- for higher pressure applications

Features and Benefits:

- leak-free performance
- high integrity in both mechanical and acoustical vibrations
- ten styles and over 400 part number configurations to meet your needs
- easy assembly – no special tools or tube preparation necessary
- reliability in side-loaded applications allows for compact plumbing
- For use with PT200, PT240, and TP160 plastic tubing
- connectors come fully assembled – for your convenience
- very low resistance to media flow resulting from material and internal surfaces
- no metal parts to corrode or present a safety hazard with aggressive chemicals
- ISO 9001 Certified

* Celcon is a registered trademark of Ticona.

** KYNAR is a registered trademark of Elf Atochem North America, Inc.

♦ Operating temperatures of Eaton connectors are regulated by ambient and fluid temperatures, type of fluid being carried, tubing type and conditions of mechanical abuse. Pressures in excess of above specifications in all connector sizes should be tested by the customer in the particular application.

Plastic Products

Molded Compression Tube Products

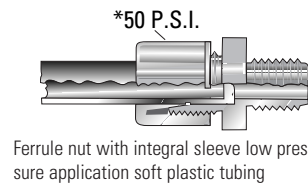
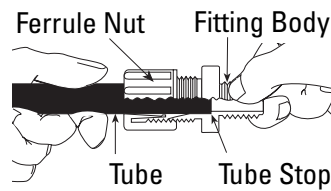

Ferrule nut with integral sleeve low pressure application soft plastic tubing

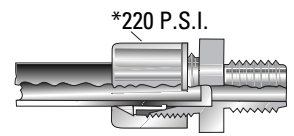

Ferrule nut with plastic gripper for use with plastic tubing for sure grip

Assembly Instructions

Maximum Operating Pressure:

Ferrule Nut series = 50 PSI max

Gripper Nut series = 220 PSI max

Operating pressures of Eaton molded compression products are regulated by ambient and fluid temperatures, type of fluid being carried, tubing type and conditions of mechanical abuse. Pressures in excess of above specifications in all fitting sizes should be tested by the customer for their particular application.

Used with:

Plastic tubing: TP160, PT200, and PT240.

Tube inserts are recommended for optimal performance with PT200 tubing.

Temperature Range:

Nylon = -40°F to +200°F (-40°C to +93°C)

Polypropylene = -30°F to +200°F (-34°C to +93°C)

Ranges are at maximum operating pressures (refer to tubing temperature range). The overlap of temperature ranges of the individual components will decide the actual temperature range of the assembly.

Assembly Instructions:

- Cut tubing to desired length; be sure the tube end is cut properly (maximum 10° cutting angle allowed).

- Insert the tubing through the back of the nut all the way through the nut assembly to the tube stop in the connector body (see illustration). If the tubing does not enter the nut easily, loosen the nut one turn and then insert the tubing all the way to the tube stop in the fitting body.
- Turn the nut to hand-tight.
- Tighten the nut an additional 2 to 2-1/2 turns past hand-tight or until the nut bottoms against the connector body, whichever comes first.
- All nuts must be retightened when the system reaches projected operating temperature.

Ordering Information

Molded compression connector are available in nylon and in polypropylene. They are also available by special order in KYNAR** (polyvinylidene fluoride) or Celcon* (acetal copolymer). To order fittings in KYNAR or Celcon, call Technical Support at 1-888-258-0222. Refer to Chemical Resistance Chart, pages 22-26. For detailed information on chemical compatibility, call Technical Support at 1-888-258-0222. General material characteristics are as follows:

Nylon, F.D.A. and N.S.F. listed, has good resistance to organic solvents, oils and gasoline. Good strength at high temperatures. Cold and hot-water applications. Longtime weathering resistance. Good impact resistance, both single and repeated. Not recommended for use with bleach, acids, or chlorine.

Polypropylene, N.S.F. listed, has good chemical resistance. Withstands continuous temperatures up to 215°F (not to exceed

temperature specification of tubing). Unaffected by most weak acids, alkalies, alcohols and ketones. Do not use with oxidants or strong acids or in continuous sunlight. 20% glass filled for improved stiffness.

KYNAR, an F.D.A. and N.S.F. listed polyvinylidene fluoride, has outstanding chemical resistance for handling highly corrosive fluids.

Celcon, an acetal copolymer, N.S.F. listed and U.S.D.A. and F.D.A. listed for coffee, milk and antibiotics, has high tensile strength and good impact resistance over a broad temperature range. Translucent white color. Not affected by continuous hot-water service and works smoothly with metal tubing. Celcon cannot be recommended for continuous exposure to solutions with a chlorine concentration greater than 1 ppm. Suggested maximum continuous-use temperature is 220°F in air and 180°F in water (not to exceed temperature specification of

tubing). Unaffected by most inorganics, except sulfuric, nitric and hydrochloric acids. Should not be continuously exposed to sunlight.

Most connectors can be ordered with a GRIPPER style nut. Fittings with a GRIPPER style nut are capable of handling greater pressure than those with standard style nut. See page 128.

For ordering connectors with 'GRIPPER' nut, add 'G' to the end of the part number (example: 1568x4x4G or 1568Px4x4G). Some connectors are NOT available with the GRIPPER style nut, while others are ONLY available with the GRIPPER style nut, as noted on pages 130-131.

For more information, call Technical Support at 1-888-258-0222.

Note:

It is not necessary to disassemble the connector for assembly. Merely insert tubing to stop and tighten compression nut.

* Celcon is a registered trademark of Ticona.

** KYNAR is a registered trademark of Elf Atochem North America, Inc.

Plastic Products

Molded Compression Tube Products

- Not available with GRIPPER style nut
- Sold ONLY with GRIPPER style nut

To order with 'GRIPPER' nut, add 'G' to the end of the part # (Except where noted!)
 Example: 1568x4x4G or 1568Px4x4G

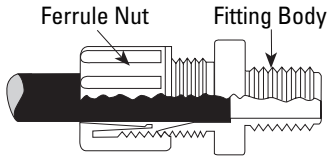

Tube O.D.	1/8 (.125)	1/4 (.250)	5/16 (.312)	3/8 (.375)	1/2 (.500)	5/8 (.625)	3/4 (.750)
Tube Thread Size	5/16-24	7/16-20	1/2-20	5/8-20	3/4-20	7/8-20	1-1/16-20

Male Connector

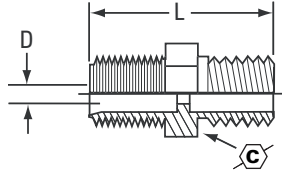

TUBE O.D.	MALE PIPE THREAD	CATALOG NUMBER NYLON	CATALOG NUMBER POLYPROPYLENE	L	D	Ⓢ
1/8	1/8	1568x2•		.88	.13	7/16
1/4	1/8	1568x4	1568Px4	.99	.26	5/8
1/4	1/8	1568x4G	1568Px4G	.99	.26	5/8
1/4	1/4	1568x4x4	1568Px4x4	1.17	.26	5/8
1/4	1/4	1568x4x4G	1568Px4x4G	1.17	.26	5/8
1/4	3/8	1568x4x6G▪	1568Px4x6	1.20	.26	13/16
5/16	1/8		1568Px5	1.00	.32	11/16
5/16	1/4	1568x5x4	1568Px5x4	1.19	.32	11/16
3/8	1/8	1568x6x2	1568Px6x2	1.14	.38	13/16
3/8	1/8		1568Px6x2G	1.14	.38	13/16
3/8	1/4	1568x6	1568Px6	1.30	.38	13/16
3/8	1/4	1568x6G	1568Px6G	1.30	.38	13/16
3/8	3/8	1568x6x6	1568Px6x6	1.34	.38	13/16
3/8	3/8	1568x6x6G		1.34	.38	13/16
3/8	1/2	1568x6x8	1568Px6x8	1.59	.38	59/64
3/8	1/2	1568x6x8G	1568Px6x8G	1.59	.38	59/64
1/2	1/8	1568x8x2G▪		1.23	.51	15/16
1/2	1/4	1568x8x4	1568Px8x4	1.42	.51	15/16
1/2	1/4		1568Px8x4G	1.42	.51	15/16
1/2	3/8	1568x8	1568Px8	1.47	.51	15/16
1/2	3/8	1568x8G	1568Px8G	1.47	.51	15/16
1/2	1/2	1568x8x8	1568Px8x8	1.61	.51	15/16
5/8	3/8	1568x10x6G▪		1.50	.63	1-1/16
5/8	1/2	1568x10G▪	1568Px10G▪	1.66	.63	1-1/16
3/4	3/4	1568x12x12G▪	1568Px12x12G▪	1.92	.76	1-5/16

Bulkhead Union

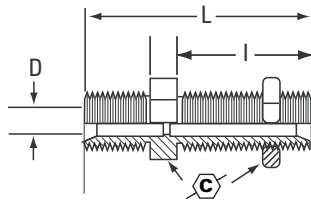
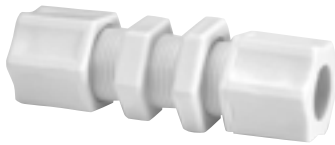

TUBE O.D.	CATALOG NUMBER NYLON	CATALOG NUMBER POLYPROPYLENE	L	I	D	Ⓢ
1/4	1574x4		1.45	.88	.26	5/8
3/8	1574x6	1574Px6	1.78	1.03	.38	13/16
1/2	1574x8		1.89	1.04	.51	15/16
3/4	1574x12G▪	1574Px12G▪	2.41	1.35	.76	1-5/16

Plastic Products

Molded Compression Tube Products

•Not available with GRIPPER style nut
 ■ Sold ONLY with GRIPPER style nut

Union Connector

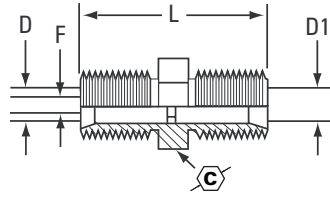

TUBE O.D.	CATALOG NUMBER NYLON	CATALOG NUMBER POLYPROPYLENE	L	F	Ⓢ
1/4	1562x4	1562Px4	.98	.23	5/8
1/4	1562x4G	1562Px4G	.98	.23	5/8
5/16	1562x5		1.03	.28	11/16
5/16	1562x5G	1562Px5G	1.03	.28	11/16
3/8	1562x6	1562Px6	1.23	.30	13/16
3/8	1562x6G	1562Px6G	1.23	.30	13/16
1/2	1562x8	1562Px8	1.44	.48	15/16
1/2		1562Px8G	1.44	.48	15/16
5/8	1562x10G■	1562Px10G■	1.50	.50	1-1/16
3/4	1562x12G■	1562Px12G■	1.75	.64	1-5/16

TUBE O.D.	TUBE O.D.	CATALOG NUMBER NYLON	CATALOG NUMBER POLYPROPYLENE	L	D	Ⓢ	D1
1/4	1/8		1562Px4x2•	.92	.26	5/8	.13
5/16	1/4	1562x5x4•		1.00	.32	11/16	.26
3/8	1/4	1562x6x4G		1.19	.38	13/16	.26
1/2	3/8		1562Px8x6	1.33	.51	15/16	.38
5/8	1/2		1562Px10x8G■	1.47	.63	1-1/16	.51

Female Connector

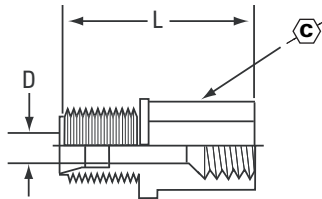

TUBE O.D.	FEMALE PIPE THREAD	CATALOG NUMBER NYLON	CATALOG NUMBER POLYPROPYLENE	L	D	Ⓢ
1/4	1/8	1566x4		.92	.23	9/16
1/4	1/8	1566x4G		.92	.23	9/16
1/4	1/4	1566x4x4	1566Px4x4	1.09	.22	11/16
1/4	1/4	1566x4x4G		1.09	.22	11/16
5/16	1/4	1566x5x4		1.22	.28	11/16
5/16	1/4	1566x5x4G		1.22	.28	11/16
3/8	1/4	1566x6		1.20	.36	11/16
3/8	3/8	1566x6x6	1566Px6x6	1.20	.36	13/16
3/8	3/8	1566x6x6G		1.20	.36	13/16
3/8	1/2	1566x6x8	1566Px6x8	1.27	.34	1-3/64
3/8	1/2	1566x6x8G	1566Px6x8G	1.27	.34	1-3/64
1/2	3/8	1566x8		1.23	.47	13/16
1/2	3/8	1566x8G		1.23	.47	13/16
1/2	1/2	1566x8x8	1566Px8x8	1.30	.48	15/16

Plastic Products

Molded Compression Tube Products

- Not available with GRIPPER style nut
- Sold ONLY with GRIPPER style nut

Female Elbow

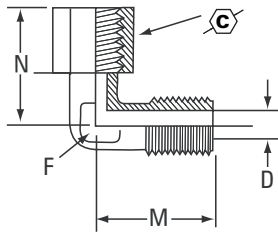

TUBE O.D.	FEMALE PIPE THREAD	CATALOG NUMBER NYLON	CATALOG NUMBER POLYPROPYLENE	M	N	D		ACROSS FLATS F
1/4	1/8	N/A		.81	.75	.26	35/64	25/64
1/4	1/4	1570x4x4		.81	.97	.26	11/16	13/32
5/16	1/4	1570x5x4G [▪]	1570Px5x4G [▪]	.94	1.00	.32	11/16	7/16
3/8	3/8	1570x6x6	1570Px6x6	.91	1.03	.38	13/16	9/16

Male Elbow

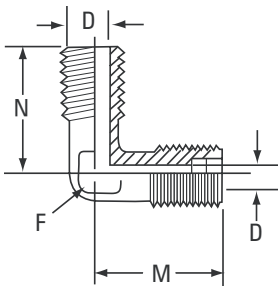

TUBE O.D.	MALE PIPE THD.	CATALOG NUMBER NYLON	CATALOG NUMBER POLYPROPYLENE	M	N	D	D1	ACROSS FLATS F
1/8	1/8		1569Px2 [•]	.56	.63	.11	.20	1/4
1/4	1/8	1569x4		.81	.81	.22	.25	3/8
1/4	1/8	1569x4G		.81	.81	.22	.25	3/8
1/4	1/4	1569x4x4	1569Px4x4	.81	1.02	.22	.28	3/8
1/4	1/4	1569x4x4G	1569Px4x4G	.81	1.02	.22	.28	3/8
1/4	3/8	1569x4x6		.84	1.09	.23	.38	9/16
3/8	1/4	1569x6	1569Px6	.94	1.03	.30	.31	37/64
3/8	1/4	1569x6G	1569Px6G	.94	1.03	.30	.31	37/64
3/8	3/8	1569x6x6	1569Px6x6	.94	1.09	.34	.38	9/16
3/8	3/8	1569x6x6G		.94	1.09	.34	.38	9/16
1/2	1/4	1569x8x4G [▪]		1.06	1.09	.39	.31	11/16
1/2	3/8	1569x8	1569Px8	1.09	1.13	.39	.31	11/16
1/2	3/8	1569x8G		1.09	1.13	.39	.31	11/16
1/2	1/2	1569x8x8	1569Px8x8	1.09	1.28	.47	.36	11/16
1/2	1/2	1569x8x8G	1569Px8x8G	1.09	1.28	.47	.36	11/16
5/8	1/2	1569x10G [▪]	1569Px10G [▪]	1.25	1.44	.52	.50	13/16

Plastic Products

Molded Compression Tube Products

•Not available with GRIPPER style nut
 ■ Sold ONLY with GRIPPER style nut

Union Tee

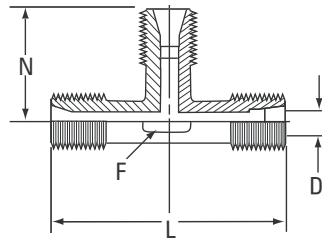

TUBE O.D.	CATALOG NUMBER NYLON	CATALOG NUMBER POLYPROPYLENE	L	D	N	ACROSS FLATS F
1/8	1564x2•		1.11	.11	.52	1/4
1/4	1564x4	1564Px4	1.44	.22	.72	23/64
1/4	1564x4G		1.44	.22	.72	23/64
5/16	1564x5G	1564Px5G	1.61	.28	.83	7/16
3/8	1564x6	1564Px6	1.91	.30	.97	17/32
3/8		1564Px6G	1.91	.30	.97	17/32
1/2	1564x8	1564Px8	2.13	.48	1.03	11/16
1/2	1564x8G		2.13	.48	1.03	11/16
5/8	1564x10G■		2.56	.50	1.25	13/16
3/4	1564x12G■		3.11	.62	1.56	1-1/16

Union Elbow

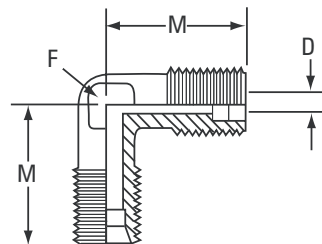

TUBE O.D.	CATALOG NUMBER NYLON	CATALOG NUMBER POLYPROPYLENE	M	D	ACROSS FLATS F
1/4	1565x4		.81	.22	3/8
1/4	1565x4G		.81	.22	3/8
3/8	1565x6	1565Px6	.94	.34	9/16
3/8	1565x6G	1565Px6G	.94	.34	9/16
1/2	1565x8	1565Px8	1.06	.39	43/64
1/2	1565x8G		1.06	.39	43/64
5/8	1565x10G■		1.25	.52	13/16

Male Branch Tee

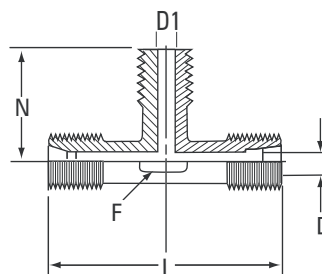

TUBE O.D.	MALE PIPE THD.	CATALOG NUMBER NYLON	CATALOG NUMBER POLYPROPYLENE	L	D	N	D1	ACROSS FLATS F
1/4	1/8	1572x4		1.45	.22	.75	.25	3/8
1/4	1/8	1572x4G		1.45	.22	.75	.25	3/8
1/4	1/4	1572x4x4x4		1.45	.22	.92	.31	3/8
1/4	1/4	1572x4x4x4G	N/A	1.45	.22	.92	.31	3/8
5/16	1/4		1572Px5x5x4	1.61	.30	.98	.31	27/64
3/8	3/8	1572x6x6x6		1.91	.36	1.11	.38	1/2
1/2	1/2	1572x8x8x8		2.19	.48	1.31	.48	5/8

Plastic Products

Molded Compression Tube Products

- Not available with GRIPPER style nut
- Sold ONLY with GRIPPER style nut

Male Run Tee

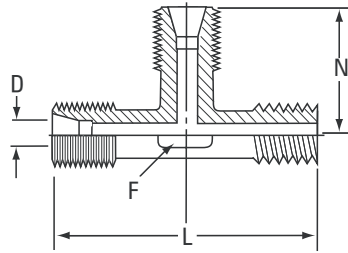

TUBE O.D.	MALE PIPE THD.	CATALOG NUMBER NYLON	CATALOG NUMBER POLYPROPYLENE	L	D	N	ACROSS FLATS F
1/4	1/8	1571x4		1.47	.22	.73	3/8
1/4	1/4	1571x4x4x4		1.67	.22	.72	23/64
1/4	1/4	1571x4x4x4G		1.67	.22	.72	23/64
5/16	1/4	1571x5x4x5G▪	1571Px5x4x5	1.81	.28	.81	7/16
3/8	3/8	1571x6x6x6	1571Px6x6x6	2.03	.34	.97	1/2
1/2	3/8	1571x8		2.27	.47	1.11	5/8
1/2	3/8		1571Px8G	2.27	.47	1.11	5/8
1/2	1/2	1571x8x8x8G▪		2.41	.47	1.11	39/64
3/4	1/2	N/A	1571Px12G▪	3.17	.64	1.55	1-1/16

Compression Nut

Ferrule Nuts with Integral Sleeve

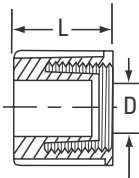
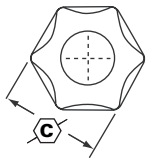

Ferrule Nuts with Integral Sleeve

TUBE O.D.	CATALOG NUMBER NYLON	CATALOG NUMBER POLYPROPYLENE		L	D
1/4	1561x4		5/8	.63	.26
5/16	1561x5		11/16	.69	.32
3/8	1561x6		13/16	.75	.38
1/2	1561x8		15/16	.88	.51

With Plastic Gripper

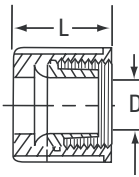

With Plastic Gripper

TUBE O.D.	CATALOG NUMBER NYLON	CATALOG NUMBER POLYPROPYLENE		L	D
1/4	1561x4G		5/8	.69	.26
3/8	1561x6G		13/16	.73	.38
1/2	1561x8G	1561Px8G	15/16	.88	.51

Insert

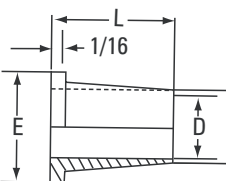

TUBE O.D.	CATALOG NUMBER NYLON	CATALOG NUMBER POLYPROPYLENE	E	L	D
1/4	1584x4		.25	.38	.12
5/16	1584x5		.31	.40	.14
3/8	1584x6		.37	.50	.20
1/2	1584x8		.49	.56	.30

Plastic Products

Molded Compression Tube Products

Cap Nut

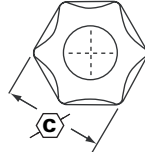
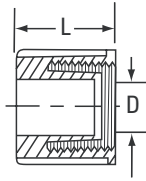

TUBE O.D.	CATALOG NUMBER NYLON	CATALOG NUMBER POLYPROPYLENE	L	
1/8	1529x2		.52	7/16
1/4	1529x4	1529Px4	.63	5/8
3/8	1529x6		.73	13/16
1/2	1529x8	1529Px8	.88	15/16

Bulkhead Nut

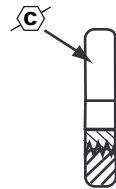

TUBE O.D.	CATALOG NUMBER NYLON	CATALOG NUMBER POLYPROPYLENE	
1/4	1502x4		5/8
5/16		1502Px5	11/16
3/8	1502x6		13/16

KYNAR Check Valve

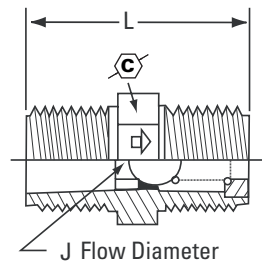

MALE PIPE SIZE N.P.T.F.	CATALOG NUMBER KYNAR ONLY	L	J	
1/8	1531x2	1.00	.09	7/16
1/4	1531x4	1.41	.19	5/8
3/8	1531x6	1.50	.25	13/16
1/2	1531x8	1.81	.34	15/16

KYNAR** Check Valve Features and Benefits:

- Viton® "O" Ring
- Stainless Ball & Spring
- Zero Leakage
- Maximum Operating Temp. 180°F @ 220 PSI
- Cracking Pressure 1 to 2.5 PSI

Viton is a registered trademark of DuPont Dow Elastomers

** KYNAR is a registered trademark of Elf Atochem North America, Inc.

Plastic Products

Plastic Products

 Refer to safety information regarding proper selection of tubing on page 1.

Straight Connector

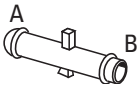

TUBE I.D. A	TUBE I.D. B	CATALOG NUMBER
1/8	1/8	1911
1/8	3/16	1923
1/8	1/4	1924
3/16	3/16	1912
1/4	3/16	1914
1/4	1/4	1913
1/4	3/8	1915
5/16	5/16	1925
3/8	3/8	1927

3 Way Tee

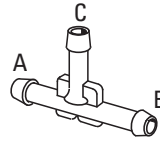

TUBE I.D. A	TUBE I.D. B	TUBE I.D. C	CATALOG NUMBER
1/8	1/8	1/8	1916
1/8	1/8	3/16	1917
1/8	1/8	1/4	1918
1/8	3/16	1/8	1939
3/16	1/8	3/16	1940
3/16	3/16	3/16	1902
3/16	3/16	1/8	1920
3/16	3/16	1/4	1921
1/4	3/16	3/16	1942
1/4	1/4	1/4	1903
1/4	1/4	3/16	1943
5/16	5/16	5/16	1906
3/8	3/16	3/8	1944
3/8	1/4	3/8	1945
3/8	3/8	3/16	1907
3/8	3/8	1/4	1908
3/8	3/8	3/8	1922

Universal Connector

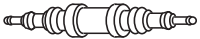

TUBE I.D. SIZE	CATALOG NUMBER
5/32-1/4-3/8	1901

Y Connector

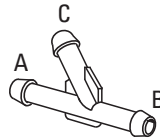

TUBE I.D. A	TUBE I.D. B	TUBE I.D. C	CATALOG NUMBER
3/16	3/16	3/16	1932
1/4	1/4	1/4	1935
1/4	3/8	3/8	1936
5/16	5/16	5/16	1937
3/8	3/8	3/8	1938

Elbow Connector

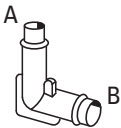

TUBE I.D. A	TUBE I.D. B	CATALOG NUMBER
1/8	3/16	1928
3/16	3/16	1929
3/16	1/4	1930
1/4	1/4	1931

4 Way Tee

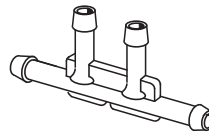

TUBE I.D. ALL ENDS	CATALOG NUMBER
3/16	1948

Universal Tee

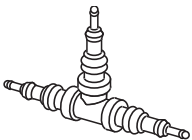

TUBE I.D. SIZE	CATALOG NUMBER
5/32-1/4-3/8	1900

5 Way Tee

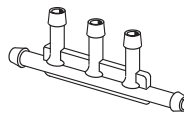

TUBE I.D. ALL ENDS	CATALOG NUMBER
3/16	1949

Temperature Range:

-40°F to +350°F.

Material: Nylon 6/6

Not recommended for fuel line applications.

Brass– Nickel Plated BSPP Products

 Refer to safety information on page 1.

BSPP Male To NPTF Female Adapter

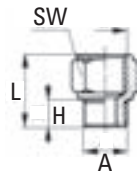

MALE BSPP	FEMALE NPTF THREAD	CATALOG NUMBER	H	L	SW (MM)
1/8	1/8	1150x2x2PP	.27	.67	14
1/4	1/4	1150x4x4PP	.32	.91	17
3/8	3/8	1150x6x6PP	.35	.96	22
1/2	1/2	1150x8x8PP	.39	1.16	27

BSPP Female To NPTF Male Adapter

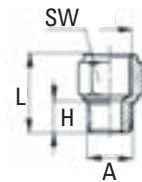

MALE BSPP	FEMALE NPTF THREAD	CATALOG NUMBER	H	L	SW (MM)
M5*	10-32†	1100x5MMxA	.18	.47	8
1/8	1/8	1100x2PPx2	.37	.77	14
1/4	1/4	1100x4PPx4	.51	1.06	17
3/8	3/8	1100x6PPx6	.51	1.08	19

*M5 has 0.8mm Thread Pitch. M5 seals with nylon washer, included.

†UNF thread

Related Products

Air Brake Products & Measuring Kits

Coiled Air Brake Tube Assemblies



Conforms to SAE J844 Type B and SAE J1131.

Conforms to DOT FMVSS 571.106.

- Spring guards zinc plated for maximum corrosion resistance.
- Provides you with error free installation.
- Preassembled for immediate installation.

 Refer to safety information on pages 1.

Maximum Working Pressure:
150 PSI

Minimum Burst:
950 PSI.

Temperature Range:
-40°F to +200°F.

Color Coding:
Red for emergency
Blue for service
Brass end fittings with spring guards and 1/2" male pipe connections.

CATALOG NUMBER	TUBE O.D.	MALE PIPE	WORKING LENGTH	PIGTAIL LENGTH
W1206*	1/2	1/2	12'	6"
W1212*	1/2	1/2	12'	12"
W1512*	1/2	1/2	15'	12"

*Each catalog number contains a coiled red assembly and a coiled blue assembly.

Thread Measuring Kit

**Weatherhead Part #
TA-1002**

**Aeroquip Part #
FT1341**

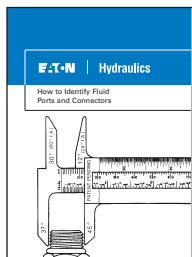

Measuring tube and pipe fitting threads can be a most difficult task if not completely understood. Tools needed include a thread pitch gauge, calipers and seat angle gauges. To aid you, Eaton has a kit to fit your needs.

This handy kit includes:

- Thread Pitch Gauge (American and metric)
- Inside/Outside Caliper (inches and millimeters)
- 2 Seat Angle Gauges (37°/45° and a 12°/30°)
- International Measuring and Identification Guide and Instruction Booklet
- Carrying Case for Easy and Convenient Storage

Related Products

Assembly & Tool Cutting Equipment

**CAUTION:**

Sharp blade! Keep hands and fingers away from cutting surface!

**T-150
Utility Tube Cutter**

Need to cut stainless steel tubing? This cutting tool is for you. It features an enclosed feed screw to eliminate clogging and jamming. Grooved rolls for close to flare cuts and a fold away reamer.

Capacity:

1/8" to 1-1/8" O.D. Cuts hard and soft copper, aluminum, brass, carbon steel and stainless steel tubing.

Spare Parts:

T-1422R Replacement Cutting Wheel

**T-1430
Inner-Outer Reamer**

Reams both inside and outside edges of tube with three hollow ground tool steel cutters. Fluted body is shaped to fit comfortably in palm of hand.

Capacity:

3/16" to 1-1/2" O.D. Reams copper, brass, aluminum and other tubing.

Related Products

Tube Cutting Equipment

Plastic Tube Cutter

Weatherhead Part #
T-135

Aeroquip Part #
FT1356



An economical alternative to quality tube and hose cutting. This versatile tool is lightweight and durable for long service life.

Replacement Blade:
Weatherhead=T-135B
Aeroquip=FT1356-2-1

 Refer to safety information on page 1.

Capacity:
Up to 1" I.D.

Note:
Not for use with wire-reinforced hose.

T-138 Hose and Tube Cutter



One hand operation for quick, clean cuts through plastic or nylon compound tubing and solid or fiber-reinforced hose up to 1" O.D.

- Any wireless hose or tubing.
- Power steering hose
- Air Conditioning hose
- Air brake hose
- Air system nylon tubing (NT100)
- Thermoplastic hose
- Low pressure plastic tubing (PT200, PT230, PT240)

Replacement Blade: T-138B

Note:
Not for use with wire-reinforced hose.

T-191 Plastic Tube and Hose Cutter



A tool designed to be small, only 2-7/8" long. The versatile T-191 offers quick and clean square cuts on 1/16" to 1/2" O.D. plastic tubing and non-wire reinforced hose. The T-191 can be either bench or wall mounted and offers the safety of closing automatically when not in use.

Spare Parts:
T-191B Replacement Blade
(one per package)

Related Products

Tube Bending Tools

 Refer to safety information on page 1.

Lever Type Tube Benders

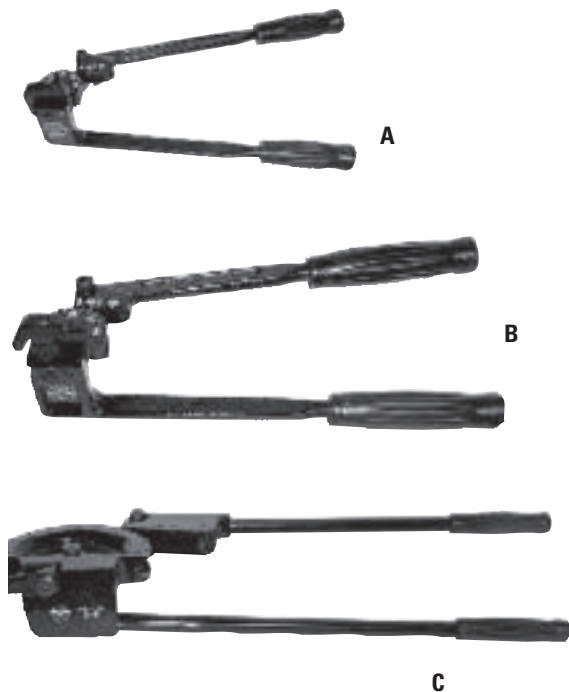

Each tool bends one size. Openside type. Handy in a tight spot. Makes precision short radius bends up to 180° with minimum effort. Keeps tube round, no marks or scrapes, shows bend degree. Unique extra strong hook grips tubing securely.

Capacity: Individual tools for bending eight sizes from 1/8" to 1" O.D. tubing. Will bend annealed copper, annealed steel (inc. JIC), stainless steel and all soft tubing.

CATALOG NUMBER	TUBING (O.D.)	NOMINAL SIZE	RADIUS TO CENTER OF TUBE	WEIGHT EACH	TYPE
T-372	1/8	—	3/8	8 ozs.	A
T-373	3/16	—	7/16	9 ozs.	A
T-374	1/4	1/8	9/16	12 ozs.	B
T-375	5/16	—	11/16	1 lb. 4 ozs.	B
T-376	3/8	—	15/16	1 lb. 12 ozs.	B
T-378	1/2	3/8	1-1/2	3 lb. 8 ozs.	B
T-3710*	5/8	1/2	2-1/4	10 lbs.	C
T-3712*	3/4	5/8	3	10 lbs. 8 ozs.	C
T-3716*	1	—	3-1/2	10 lbs. 8 ozs.	C

* Will bend annealed copper and aluminum tubing only.

Spring Tube Benders



Low cost, tube bending spring operates perfectly in hand bending copper, aluminum and other thin-walled tubing. Bends are true with

minimum tubewall collapsing. Belled at one end to facilitate removal. Bright-plated spring wire finish.

CATALOG NUMBER	TUBING (O.D.) (INCHES)	LENGTH (INCHES)	WEIGHT
T-104	1/4	10	4 ozs.
T-105	5/16	10	4 ozs.
T-106	3/8	10	5 ozs.
T-107	7/16	12	7 ozs.
T-108	1/2	12	8 ozs.
T-1010	5/8	12	10 ozs.
SETS			
T-100	1/4, 3/8, 1/2, 5/8	10 & 12	1-1/2 lbs.
T-200	1/4, 5/16, 3/8, 1/2	10 & 12	1-1/4 lbs.

Equipment

Tube Flaring & Brazing Tools

 Refer to safety information on page 1.

T-345K Tube Cutting and Flaring Kit



Tube flaring and cutting has just become a little easier with the convenient T-345K Tube Flaring and Cutting Kit.

This kit features a quality-made Double Flaring Tool offering accurate single flares between 3/16" and 5/8" O.D. tubing. Double flares between 3/16" and 1/2" O.D. tubing.

Check these features:

- Hardened, smooth cone for fast, accurate 45° flares.
- Single and double flare capability.
- Clamp screw for easy clamping and removal of tubes.
- Flaring Bar installed from either side of yoke.
- Flares soft copper, brass, aluminum and mild steel (JIC and Bundy) tubing.

T-345K

Components can be ordered separately:

T-345

45° Flaring Tool, Double Flare Adapters and Plastic Box

T-150

1/8" to 1-1/8" Tube Cutter

T-1422R

T-150 Spare Cutting Wheel

DOUBLE FLARE ADAPTERS

Catalog Number	Tube O.D.
T-346x3	3/16"
T-346x4	1/4"
T-346x5	5/16"
T-346x6	3/8"
T-346x8	1/2"

T-1022 Flaring Tool (45°)

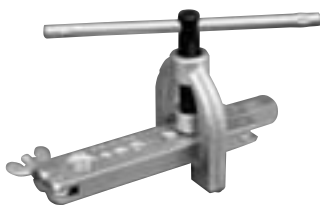

Economical, fast operating tool. Quick slip-on aluminum alloy yoke. Easy operating, swivel-type, hard chrome finished cone assures smooth flares.

Yoke slips down over top of bar and locks into position with a single turn.

Flaring Capacity:

3/16", 1/4", 5/16", 3/8", 7/16", 1/2", and 5/8" O.D. Forms 45° flares in soft copper, aluminum and brass.

T-220 Double Flaring Tool (45°)

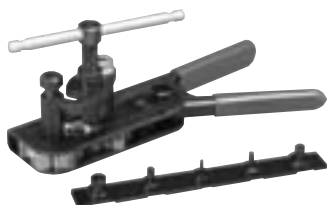

This new style tool makes single or double flaring easier and quicker than ever. Cam action provides positive, non-slip grip on the tubing with just a squeeze of the handle. Double flaring bar also serves as gauge for correct tubing height to insure perfect flares.

used with copper, aluminum, brass, bundyweld and steel tubing.

Weight:

2 lbs.

T-220 Components can be ordered separately

T-210 Tool for single flaring only

T-221 Double Flaring Bar only.

Flaring Capacity:

3/16", 1/4", 5/16", 3/8" and 1/2"

Flaring Capacity:

3/16", 1/4", 5/16", 3/8", 1/2" and 5/8" O.D. for single flares, and up to 1/2" O.D. for double flares. Can be

Related Products

Label Sets & Bags

 Refer to safety information on page 1.

Label Sets

Full assortment available. Each label contains catalog number, illustration, size data and color coding for quick, positive identification of parts. Labels slide easily into slots on drawers and dividers.



CATALOG NUMBER	DESCRIPTION
CL-490	Standard brass products, drain and shut-off cocks.
CL-491	Air brake products for copper tubing.
CL-492	Hydraulic brake products.
CL-494	Master Set - contains one each of CL-490, CL-491, CL-492.
CL-496	Mini-Barb products.
CL-497	Air brake products for nylon tubing.
CL-498	Polyline products.
CL-499	Push>Connect
CL-500	Selfalign
CL-501	Plastic products
CL-503	QCAB products

Self-Adhesive Label Sets

Labels are printed on self-adhesive stock for quick application. Each label contains an illustration of the part along with the catalog number and size information.



CATALOG NUMBER	DESCRIPTION
FS-800	Air brake products for copper tubing
FS-900	Air brake products for nylon tubing
FS-1000	Mini-Barb products
FS-2100	Polyline products
FS-3300	QCAB products
W-8022	Standard brass products and drain-shut-off valve

Plastic Bags

Eaton heavy-duty plastic bags for brass products come in sizes 5"x6", 6"x10", and 8"x12". The bags include convenient spaces for labeling.



CATALOG NUMBER	DESCRIPTION	QTY.
5x6 PB	Plastic Bag	100
6x10 PB	Plastic Bag	100
8x12 PB	Plastic Bag	100

Related Products

Cabinets & Assortments

Stock Cabinet

Weatherhead Part #
FC-16X
Aeroquip Part #
FT1600



Contains 16 clear plastic drawers that can be divided into two or three sections. Illustrated color labels are available to provide instant identification of drawer contents.

Size:
16-1/8" wide x 11-3/4" high x 9" deep
Weight:
13 lbs.

Stock Cabinet

Weatherhead Part #
C-15X
Aeroquip Part #
FT1601



Contains 15 extra large white drawers for those large, difficult to store items. The 15 drawers may be divided into two or three sections to suit your particular needs.

Size:
30-1/4" Wide x 14-3/8" Deep x 13-5/8" High
Weight:
45 lbs.

WEATHERHEAD PART #	AEROQUIP PART #	DESCRIPTION
CD-15	FT1605	Individual Drawers
CD-15D	FT1606	Dividers

Stock Cabinet

Weatherhead Part #
C-63X
Aeroquip Part #
FT1602



A cabinet containing 63 drawers that can be divided into two or three sections. The bright color and attractive design make the stock cabinet a nice addition to any store front.

Size:
30-1/4" wide x 25" high x 9-1/4" deep
Weight:
61 lbs.

Cabinet

Weatherhead Part #
2: C-63X,
1: C-15X,
1: CB-63X
Aeroquip Part #
2: FT1602,
1: FT1601,
1: CB-63X



This Brass Products Cabinet is a space saving, efficient, easy to use addition to the modern store with lobby type sales area. The cabinet requires a minimum of space but does a maximum job merchandising the wide variety of products in the 126 clear, wide, plastic drawers. An additional 15 large, high impact plastic drawers located in the bottom section provide ample space for those large or heavy special items you may be stocking.

standard box quantities listed on labels. Plastic dividers are provided to section drawers for future expansion when new or additional part numbers are needed.

Display this attractive cabinet with a recommended stock in your lobby and watch your brass product sales increase as the cabinet silently and quickly services your customers. Create those impulse sales that make your business and profits grow!

Restocking is easy when you start at the bottom and pull drawers for an order check. Leave drawers extended that are low in stock. Now start at top, note quantity needed and return drawers to original position after order is written using

For complete details on the assortment, see page 143

Size:
68-1/2" high, 30" wide, 15" deep.
Weight:
167 lbs.

WEATHERHEAD PART #	AEROQUIP PART #	DESCRIPTION
C-15X	FT1601	15 Drawer Cabinet
C-63X	FT1602	63 Drawer Cabinet
CB-63X	CB-63X	Cabinet Base
CD-15	FT1605	Plastic Drawer for C-15X/ FT1601

Related Products

Assortments

CA-632CO Brass Products Assortment

The CA-632CO is an assortment of fast moving brass products with coverage for most any application. This space saving assortment includes color coded, illustrated, labels for quick identification by customers of standard products, as well as fuel line, carburetion, metric and domestic hydraulic

brake and thermoplastic brass fittings in 240 configurations and sizes. Be a supplier to auto dealers, brake specialists, RV shops, plant maintenance shops, truck and bus fleets, contractors, marinas, loggers, shipyards, fishing fleets, farmers and self installers for their brass requirements. Contents

of this assortment may vary as new products are introduced and stock changes in popularity.

CA-632CO CONTENTS

Catalog Number	Qty.	Catalog Number	Qty.	Catalog Number	Qty.	Catalog Number	Qty.	Catalog Number	Qty.	Catalog Number	Qty.
05703B-102	5	1540	10	3220x6x4	10	3700x4	5	61x2	10	6829	5
05704B-102	10	202x3	10	3220x8x2	5	3700x6	5	61x3	20	6892	5
05704B-104	5	202x4	10	3220x8x4	10	3750x2	5	61x4	20	69x2	10
05704B-C02	5	202x4x4	10	3220x8x6	5	3750x4	5	61x5	20	69x3	10
05705B-102	10	202x5	10	3220x12x6	2	402x3	10	61x6	10	69x4	10
05705B-104	5	202x5x4	10	3220x12x8	2	402x4	10	61x8	10	69x4x4	10
05705B-C02	10	202x6	10	3300x2	10	402x4x4	5	6100x2	10	69x5	10
05705B-C04	10	202x6x2	5	3300x4	10	402x5	10	6100x3	10	69x5x4	10
05705B-1560	10	2030x4	10	3300x4x2	10	402x5x4	10	6100x4	10	69x6	10
05705B-1561	10	2030x44	10	3300x6	5	402x6	10	62x2	10	69x6x2	5
05706B-102	10	2030x5	10	3300x6x4	5	41x3	10	62x3	10	69x6x6	5
05706B-104	10	2030x6	10	3300x8	5	41x4	10	62x4	10	69x8	5
05706B-106	5	2030x8	5	3300x8x6	5	41x5	10	62x5	10	7818	5
05706B-C02	5	252x3	10	3325x2	10	41x6	10	62x6	10	7828	5
05706B-C04	5	252x4	10	3325x4	10	41x8	5	62x8	5	7829	5
05706B-1568	5	270	5	3325x4x2	5	42x4	5	62x10	1	7896x3	5
05706B-1570	5	302x3	10	3325x6	5	42x6	5	6200x2	10	7896x4	5
100x3	10	302x4	10	3325x6x4	5	48x3	10	6200x3	10	7904	5
100x4	10	302x5	10	3326x2	10	48x4	10	6200x4	10	7906	5
100x5	10	302x6	5	3326x4	10	48x4x4	10	6205-004	10	7908	2
100x6	10	3129x2	5	3326x6	10	48x5	10	64x4	5	7914	2
105x2	10	3150x2	10	3326x8	5	48x5x4	10	64x6	5	7934A	5
105x3	20	3150x4	10	3327x2	10	48x6	10	66x2	10	7935	5
105x4	20	3151x2	10	3327x4	5	48x6x2	5	66x3	10	7936	5
105x5	20	3151x4	10	3328x2	10	48x6x6	5	66x4	10	7937	5
105x6	10	3151x6	10	3328x4	5	48x8	5	66x6	5	7940	5
131x3	10	3151x8	5	3328x6	5	49x4	10	6660	5	7941	5
131x4	10	3152x2	10	3350x2	5	49x4x4	5	6749	1		
131x5	10	3152x4	10	3350x4	5	49x5	10	68x2	10		
131x6	10	3152x6	10	3350x6	5	49x5x4	5	68x3	10		
135	10	3152x8	5	3400x2	10	49x6	10	68x4	10		
140	5	3152x12	2	3400x4	10	49x8	5	68x4x4	10		
1442	5	3200x2	10	3400x6	5	60x2	50	68x5	10		
1443	5	3200x4	5	3400x8	5	60x3	50	68x5x4	10		
145	10	3200x4x2	10	3500x2	10	60x4	50	68x6	10		
1514	5	3200x6x4	5	3500x4	10	60x5	50	68x6x2	10		
1538	10	3200x8x6	5	3600x2	5	60x6	50	68x6x6	5		
1548	10	3220x4x2	20	3600x4	5	60x8	20	68x8	5		
1539	10	3220x6x2	10	3700x2	10	60x10	10	6809	5		

Related Products

Assortments

Brass Products Assortment

Weatherhead Part #

CA-631

Aeroquip Part #

FT1607



This merchandiser will help you organize your brass products in an attractive 63 drawer cabinet. It includes a stock of the 100 fastest moving brass products to better service your customers. To expand, divide the clear, easy to inventory, super sized plastic drawers in half or thirds with plastic dividers provided. Illustrated, color-coded labels in a wide range of connector types provide instant identi-

fication of drawer contents. Your lobby and sales will be improved with this modern display set up on a gondola or shelf. Contents may vary as new numbers become available and popularity changes.

CA-631 CONTENTS

Catalog Number	Qty.	Catalog Number	Qty.	Catalog Number	Qty.	Catalog Number	Qty.	Catalog Number	Qty.	Catalog Number	Qty.
105x3	20	302x4	10	3200x4x2	10	3326x6	10	48x4x4	10	62x2	10
105x4	20	302x5	10	3200x6x4	5	3327x2	5	48x5	10	62x3	10
105x5	20	302x6	5	3220x4x2	20	3327x4	5	48x5x4	10	62x4	10
105x6	10	402x4	10	3220x6x2	10	3328x2	5	48x6	10	62x5	10
131x3	10	402x5	10	3220x6x4	10	3328x4	5	48x6x6	5	62x6	10
131x4	10	402x6	10	3220x8x2	5	3350x2	5	49x4	5	68x2	10
131x5	10	3150x2	5	3220x8x4	10	3350x4	5	49x6	10	68x3	10
131x6	10	3150x4	5	3220x8x6	5	3400x2	10	60x2	50	68x4	10
135	10	3151x2	10	3300x2	10	3400x4	10	60x3	50	68x4x4	10
145	10	3151x4	10	3300x4	10	3400x6	5	60x4	50	68x5	10
202x3	10	3151x6	10	3300x4x2	10	3700x2	10	60x5	50	68x5x4	10
202x4	10	3151x8	10	3300x6	5	3700x4	5	60x6	50	68x6	10
202x4x4	10	3152x2	10	3300x6x4	5	3750x4	5	61x2	10	68x6x2	10
202x5	10	3152x4	10	3325x2	10	3750x6	2	61x3	10	69x4	10
202x5x4	10	3152x6	10	3325x4	10	41x4	10	61x4	10	69x6	10
202x6	5	3152x8	5	3326x2	10	41x6	10	61x5	10	C-63X or FT1602	1
302x3	10	3200x2	5	3326x4	10	48x4	10	61x6	10	CL-490	1

Brass Products Assortment

Weatherhead Part #

FC-161

Aeroquip Part #

FT1608



The brass products assortment contains the fastest moving SAE 45° Flare, Inverted Flare, Compression and Pipe catalog numbers to give your customers maximum coverage at a low cost. Nuts, sleeves and unions make an ideal stock for any

small repair, auto, boat, lawn mower, or fixit shop. Cabinet includes 16 clear plastic drawers and color-coded labels for easy identification. The cabinet fits on any shelf and goes to work immediately.

FC-161 CONTENTS

Catalog Number	Qty.	Catalog Number	Qty.	Catalog Number	Qty.	Catalog Number	Qty.	Catalog Number	Qty.	Catalog Number	Qty.
105x3	10	302x5	2	402x3	2	49x4	2	61x5	10	69x4	2
105x4	10	3151x2	2	402x4	2	49x5	2	61x6	5	69x5	2
105x5	10	3151x4	2	402x5	2	49x6	2	62x3	5	69x6	2
105x6	5	3220x4x2	5	41x4	2	60x3	20	62x4	5	CL-16-1	1
145	5	3220x6x4	5	41x5	2	60x4	20	62x5	5	FC-16X or FT1600	1
202x4	2	3300x2	5	41x6	2	60x5	20	62x6	5		
202x5	2	3300x4	2	48x4	2	60x6	20	68x4	2		
302x3	5	3400x2	5	48x5	2	61x3	10	68x5	2		
302x4	5	3400x4	5	48x6	2	61x4	10	68x6	2		

Related Products

Assortments

Push>Connect Products Assortment

**Weatherhead Part #
PC-48**

**Aeroquip Part #
FT1613**



Eaton PUSH > CONNECT products are designed for quick assembly without the need for a wrench. Ideal for pneumatic applications where space is tight. Then product is also easily disconnected; simply depress the collet ring with two fingers and withdraw the tube. The

PC-48 and FT1613 provides the 48 most popular PUSH > CONNECT products in a compact, handy plastic box to make your assortment organized and accessible.

CA-631 CONTENTS

Catalog Number	Qty.	Catalog Number	Qty.	Catalog Number	Qty.	Catalog Number	Qty.	Catalog Number	Qty.	Catalog Number	Qty.
1162x2	5	1165x6	5	1168x2.5x4	5	1168x6x6	5	1169x4x6S	5	1172x4x4S	5
1162x4	5	1165x8	2	1168x2x4	5	1168x6x8	2	1169x6S	5	1174x2	5
1162x6	5	1166x4	5	1168x4	5	1168x8	5	1169x6x6S	5	1174x4	5
1164x2.5	5	1166x4x4	5	1168x4A	5	1168x8x8	2	1169x8S	2	CL-499	1
1164x4	5	1166x6	5	1168x4x4	5	1169x2.5S	5	1169x8x4S	2	FC-16X or FT1600	1
1164x6	5	1166x6x6	2	1168x4x6	5	1169x2S	5	1171x4S	5		
1164x8	2	1168x2	2	1168x5	5	1169x2x4S	5	1171x4x4S	5		
1165x2.5	5	1168x2.5	5	1168x5x4	5	1169x4S	5	1171x6S	5		
1165x4	5	1168x2.5A	5	1168x6	5	1169x4x4S	5	1172x4S	5		

Certification

ISO & QS Certifications

Eaton Hydraulics - Brass Products

FACILITY	REGISTRATION	REGISTRAR NUMBER	PRODUCT RESPONSIBILITY
CLEVELAND, TN	ISO9002	SGSUS98/1495	Distribution of Eaton Product
VINITA, OK	ISO/QS9000 ISO14001	ULA5225 ULA6947	Brass Products Manufacturing

Conversion

Conversion Chart

INCHES FRACTIONS	DECIMALS	MM	INCHES FRACTIONS	DECIMALS	MM	INCHES FRACTIONS	DECIMALS	MM	INCHES FRACTIONS	DECIMALS	MM
—	.0004	.0100	—	.3150	8.0000	11/16	.6875	17.4630	—	1.1811	30.0000
—	.0040	.1000	21/64	.3280	8.3340	45/64	.7030	17.8590	1-3/16	1.1875	30.1630
—	.0100	.2500	—	.3350	8.5000	—	.7087	18.0000	1-7/32	1.2190	30.9560
1/64	.0156	.3970	11/32	.3440	8.7310	23/32	.7190	18.2560	—	1.2205	31.0000
—	.0197	.5000	—	.3543	9.0000	—	.7283	18.5000	1-1/4	1.2500	31.7500
—	.0295	.7500	23/64	.3590	9.1280	47/64	.7340	18.6530	—	1.2598	32.0000
1/32	.0313	.7940	—	.3740	9.5000	—	.7480	19.0000	1-9/32	1.2810	32.5440
—	.0394	1.0000	3/8	.3750	9.5250	3/4	.7500	19.0500	—	1.2992	33.0000
3/64	.0469	1.1910	25/64	.3910	9.9220	49/64	.7656	19.4470	1-5/16	1.3120	33.3380
—	.0590	1.5000	—	.3937	10.0000	25/32	.7810	19.8440	—	1.3386	34.0000
1/16	.0620	1.5880	13/32	.4060	10.3190	—	.7874	20.0000	1-11/32	1.3440	34.1310
5/64	.0781	1.9840	—	.4130	10.5000	51/64	.7970	20.2410	1-3/8	1.3750	34.9250
—	.0787	2.0000	27/64	.4220	10.7160	13/16	.8125	20.6380	—	1.3779	35.0000
3/32	.0940	2.3810	—	.4331	11.0000	—	.8268	21.0000	1-13/32	1.4060	35.7190
—	.0984	2.5000	7/16	.4380	11.1130	53/64	.8280	21.0340	—	1.4173	36.0000
7/64	.1090	2.7780	29/64	.4530	11.5090	27/32	.8440	21.4310	1-7/16	1.4380	36.5130
—	.1181	3.0000	15/32	.4690	11.9060	55/64	.8590	21.8280	—	1.4567	37.0000
1/8	.1250	3.1750	—	.4724	12.0000	—	.8662	22.0000	1-15/32	1.4690	37.3060
—	.1378	3.5000	31/64	.4840	12.3030	7/8	.8750	22.2250	—	1.4961	38.0000
9/64	.1410	3.5720	—	.4920	12.5000	57/64	.8906	22.6220	1-1/2	1.5000	38.1000
5/32	.1560	3.9690	1/2	.5000	12.7000	—	.9055	23.0000	1-17/32	1.5310	38.8940
—	.1575	4.0000	—	.5118	13.0000	29/32	.9062	23.0190	—	1.5354	39.0000
11/64	.1720	4.3660	33/64	.5156	13.0970	59/64	.9220	23.4160	1-9/16	1.5620	39.6880
—	.1770	4.5000	17/32	.5310	13.4940	15/16	.9375	23.8130	—	1.5748	40.0000
3/16	.1875	4.7630	35/64	.5470	13.8910	—	.9449	24.0000	1-19/32	1.5940	40.4810
—	.1969	5.0000	—	.5512	14.0000	61/64	.9530	24.2090	—	1.6142	41.0000
13/64	.2030	5.1590	9/16	.5630	14.2880	31/32	.9690	24.6060	1-5/8	1.6250	41.2750
—	.2165	5.5000	—	.5710	14.5000	—	.9843	25.0000	—	1.6535	42.0000
7/32	.2190	5.5560	37/64	.5790	14.6840	63/64	.9844	25.0030	1-31/32	1.6562	42.0690
15/64	.2340	5.9530	—	.5906	15.0000	1	1.0000	25.4000	1-11/16	1.6875	42.8630
—	.2362	6.0000	19/32	.5940	15.0810	—	1.0236	26.0000	—	1.6929	43.0000
1/4	.2500	6.3500	39/64	.6090	15.4780	1-1/32	1.0312	26.1940	1-23/32	1.7190	43.6560
—	.2559	6.5000	5/8	.6250	15.8750	1-1/16	1.0620	26.9880	—	1.7323	44.0000
17/64	.2656	6.7470	—	.6299	16.0000	—	1.0630	27.0000	1-3/4	1.7500	44.4500
—	.2756	7.0000	41/64	.6406	16.2720	1-3/32	1.0940	27.7810	—	1.7717	45.0000
9/32	.2810	7.1440	—	.6496	16.5000	—	1.1024	28.0000	1-25/32	1.7810	45.2440
—	.2953	7.5000	21/32	.6560	16.6690	1-1/8	1.1250	28.5750	—	1.8110	46.0000
19/64	.2970	7.5410	—	.6693	17.0000	—	1.1417	29.0000	1-13/16	1.8125	46.0380
5/16	.3120	7.9380	43/64	.6720	17.0660	1-5/32	1.1560	29.3690	1-27/32	1.8440	46.8310

Conversion

Conversion Chart

INCHES FRACTIONS	DECIMALS	MM	INCHES FRACTIONS	DECIMALS	MM	INCHES FRACTIONS	DECIMALS	MM	INCHES FRACTIONS	DECIMALS	MM
–	1.8504	47.0000	2-1/2	2.5000	63.5000	–	3.1496	80.0000	3-25/32	3.7810	96.0440
1-7/8	1.8750	47.6250	–	2.5197	64.0000	3-5/32	3.1560	80.1690	3-13/16	3.8125	96.8380
–	1.8898	48.0000	2-17/32	2.5310	64.2940	3-3/16	3.1875	80.9630	–	3.8189	97.0000
1-29/32	1.9062	48.4190	–	2.5590	65.0000	–	3.1890	81.0000	3-26/32	3.8440	97.6310
–	1.9291	49.0000	2-9/16	2.5620	65.0880	3-7/32	3.2190	81.7560	–	3.8583	98.0000
1-15/16	1.9375	49.2130	2-19/32	2.5940	65.8810	–	3.2283	82.0000	3-7/8	3.8750	98.4250
–	1.9685	50.0000	–	2.5984	66.0000	3-1/4	3.2500	82.5500	–	3.8976	99.0000
1-31/32	1.9690	50.0060	2-5/8	2.6250	66.6750	–	3.2677	83.0000	3-29/32	3.9062	99.2190
2	2.0000	50.8000	–	2.6380	67.0000	3-9/32	3.2810	83.3440	–	3.9370	100.0000
–	2.0079	51.0000	2-21/32	2.6560	67.4690	–	3.3071	84.0000	3-15/16	3.9375	100.0130
2-1/32	2.0313	51.5940	–	2.6772	68.0000	3-5/16	3.3120	84.1377	3-31/32	3.9690	100.8060
–	2.0472	52.0000	2-11/16	2.6875	68.2630	3-11/32	3.3440	84.9314	–	3.9764	101.0000
2-1/16	2.0620	52.3880	–	2.7165	69.0000	–	3.3464	85.0000	4	4.0000	101.6000
–	2.0866	53.0000	2-23/32	2.7190	69.0560	3-3/8	3.3750	85.7250	4-1/16	4.0620	103.1880
2-3/32	2.0940	53.1810	2-3/4	2.7500	69.8500	–	3.3858	86.0000	4-1/8	4.1250	104.7750
2-1/8	2.1250	53.9750	–	2.7559	70.0000	3-13/32	3.4060	86.5190	–	4.1338	105.0000
–	2.1260	54.0000	2-25/32	2.7810	70.6439	–	3.4252	87.0000	4-3/16	4.1875	106.3630
2-5/32	2.1560	54.7690	–	2.7953	71.0000	3-7/16	3.4380	87.3130	4-1/4	4.2500	107.9500
–	2.1650	55.0000	2-13/16	2.8125	71.4376	–	3.4646	88.0000	4-5/16	4.3120	109.5380
2-3/16	2.1875	55.5630	–	2.8346	72.0000	3-15/32	3.4690	88.1060	–	4.3307	110.0000
–	2.2047	56.0000	2-27/32	2.8440	72.2314	3-1/2	3.5000	88.9000	4-3/8	4.3750	111.1250
2-7/32	2.2190	56.3560	–	2.8740	73.0000	–	3.5039	89.0000	4-7/16	4.4380	112.7130
–	2.2440	57.0000	2-7/8	2.8750	73.0250	3-17/32	3.5310	89.6940	4-1/2	4.5000	114.3000
2-1/4	2.2500	57.1500	2-29/32	2.9062	73.8190	–	3.5433	90.0000	–	4.5275	115.0000
2-9/32	2.2810	57.9440	–	2.9134	74.0000	3-9/16	3.5620	90.4877	4-9/16	4.5620	115.8880
–	2.2835	58.0000	2-15/16	2.9375	74.6130	–	3.5827	91.0000	4-5/8	4.6250	117.4750
2-5/16	2.3120	58.7380	–	2.9527	75.0000	3-19/32	3.5940	91.2810	4-11/16	4.6875	119.0630
–	2.3228	59.0000	2-31/32	2.9690	75.4060	–	3.6220	92.0000	–	4.7244	120.0000
2-11/32	2.3440	59.5310	–	2.9921	76.0000	3-5/8	3.6250	92.0750	4-3/4	4.7500	120.6500
–	2.3622	60.0000	3	3.0000	76.2000	3-21/32	3.6560	92.8960	4-13/16	4.8125	122.2380
2-3/8	2.3750	60.3250	3-1/32	3.0312	76.9940	–	3.6614	93.0000	4-7/8	4.8750	123.8250
–	2.4016	61.0000	–	3.0315	77.0000	3-11/16	3.6875	93.6630	–	4.9212	125.0000
2-13/32	2.4060	61.1190	3-1/16	3.0620	77.7880	–	3.7008	94.0000	4-15/16	4.9375	125.4130
2-7/16	2.4380	61.9130	–	3.0709	78.0000	3-23/32	3.7190	94.4560	5	5.0000	127.0000
–	2.4409	62.0000	3-3/32	3.0940	78.5810	–	3.7401	95.0000			
2-15/32	2.4690	62.7060	–	3.1102	79.0000	3-3/4	3.7500	92.2500			
–	2.4803	63.0000	3-1/8	3.1250	79.3750	–	3.7795	96.0000			

Glossary

Alpha/Numeric

A:

abrasion: external damage to a hose assembly caused by its being rubbed on a foreign object; a wearing away by friction.

ABS: Air-Brake Swivel

absorption: regarding hose, the process of taking in fluid. Hose materials are often compared with regard to relative rates and total amounts of absorption as they pertain to specific fluids.

acid resistant: having the ability to withstand the action of identified acids within specified limits of concentration and temperature.

adapter, adaptor:

1. connectors of various sizes and materials used to change an end connector from one type to another type or one size to another. (i.e., a male SAE to male pipe adapter is often attached to a female SAE to create a male end union connector);
2. the grooved portion of a cam & groove coupling.

adhesion: the strength of bond between cured rubber surfaces or between a cured rubber surface and a non-rubber surface.

adhesive: a material which, when applied, will cause two surfaces to adhere.

ambient/atmospheric conditions: The surrounding conditions, such as temperature, pressure, and corrosion, to which a hose assembly is exposed.

anchor: a restraint applied to eliminate motion and restrain forces.

anodize, anodized: an electrolytic process used to deposit protective or cosmetic coatings in a variety of colors on metal, primarily

used with aluminum.

ANSI: American National Standards Institute.

Application working pressure: unique to customer's application. See pressure, working.

assembly: a general term referring to any hose coupled with end connectors of any style attached to one or both ends.

ASTM: American Society for Testing and Materials.

axial movement: compression or elongation along the longitudinal axis.

B:

barb: the portion of a connector (coupling) that is inserted into the hose, usually comprised of two or more radial serrations or ridges designed to form a redundant seal between the hose and connector.

barbed and ferrule connector: a two-piece hose

connector comprised of a barbed insert (nipple), normally with peripheral ridges or backward-slanted barbs, for inserting into a hose and a ferrule, usually crimped or swaged.

bend radius: the radius of a bent section of hose measured to the innermost surface of the curved portion.

bend radius, minimum: the smallest radius at which hose or tubing can be used. For Metal Hose: the radius of a bend measured to the hose centerline, as recommended by the manufacturer.

bore:

1. an internal cylindrical passageway, as of a tube, hose or pipe;
2. the internal diameter of a tube, hose, or pipe.

braid: the woven portion of a hose used as reinforcement to increase pressure rating and add hoop

strength. Various materials such as polyester, cotton or metal wire are used. A hose may have one or more braids, outside or between layers of hose material.

braided ply: a layer of braided reinforcement.

brand: a mark or symbol identifying or describing a product and/or manufacturer, that is embossed, inlaid or printed.

brass: a family of copper/zinc alloys.

brazing: a process of joining metals using a non-ferrous filler metal having a melting point that is lower than the "parent metals" to be joined, typically over +800°F.

bronze: an alloy of copper, tin and zinc.

BSPP/BSPT: British Standard Pipe Parallel / British Standard Pipe Tapered. See Connector/Coupling - Pipe Thread Connectors.

C:

chalking: the formation of a powdery surface condition due to disintegration of surface binder or elastomer by weathering or other destructive environments.

chemical compatibility: the relative degree to which a material may contact another without corrosion, degradation or adverse change of properties.

chemical resistance: the ability of a particular polymer, rubber compound, or metal to exhibit minimal physical and/or chemical property changes when in contact with one or more chemicals for a specified length of time, at specified concentrations, pressure, and temperature.

cold flexibility: relative ease of bending while being exposed to specified low temperature.

combustible liquid: a

combustible liquid is one having a flash point at or above +100°F (37.8°C).

compound: the mixture of rubber or plastic and other materials, which are combined to give the desired properties when, used in the manufacture of a product.

compression connector: see connector/coupling - Compression

conductive: the ability to transfer electrical potential.

configuration: the combination of connectors on a particular assembly.

core: the inner portion of a hose, usually referring to the material in contact with the medium.

corrosion: the process of material degradation by chemical or electrochemical means.

corrosion resistance: ability of metal components to resist oxidation.

coupling: a frequently used alternative term for hose end connector.

cover: the outer component usually intended to protect the carcass of a product.

CPE: chlorinated polyethylene, a rubber elastomer.

cracking: a sharp break or fissure in the surface, generally caused by strain and environmental conditions.

D:

date code: any combination of numbers, letters, symbols or other methods used by a manufacturer to identify the time of manufacture of a product.

deburr: to remove ragged edges from the inside diameter of a hose end.

design factor: a ratio used to establish the working pressure of the hose, based on the burst strength of the hose.

DOT: Department of Transportation.

Glossary

Alpha/Numeric

DIN: Deutsche Industrie Norme.

durometer: an instrument for measuring the hardness of rubber and plastic compounds.

E:

eccentricity: the condition resulting from the inside and outside diameters not having a common center.

effusion: the escape, usually of gases, through a material. See permeation.

elastic limit: the limiting extent to which a body may be deformed and yet return to its original shape after removal of the deforming force.

elastomer: any one of a group of polymeric materials, usually designated thermoset, such as natural rubber, or thermoplastic, which will soften with application of heat.

elongation: the increase in length expressed numerically as a percentage of the initial length.

endurance test: a service or laboratory test, conducted to product failure, usually under normal use conditions.

extrude/extruded/extrusion: forced through the shaping die of an extruder; extrusion may have a solid or hollow cross section.

F:

fabricator: the producer of hose and tubing assemblies.

fatigue: the weakening or deterioration of a material occurring when a repetitious or continuous application of stress causes strain, which could lead to failure.

FDA: United States Food and Drug Administration.

connector/coupling: a device attached to the end of the hose to facilitate connection. The following is only

a partial list of types of connectors available:

Compression Connector- a connector style that seals on a mating tube by compressing an internal ferrule against the tube O.D.

Field Attachable Connector a connector designed to be attached to hose without crimping or swaging. This connector is not always a reusable type connector.

Inverted Flare Connector a connector consisting of a male or female nut, trapped on a tube by flaring the end of the tube material to either 37° or 45°.

JIC Connectors - joint Industrial Council (no longer in existence). An engineering group that established an industry standard connector design incorporating a 37° mating surface, male and female styles. These standards are now governed by SAE.

O-ring Connectors - a connector that seals by means of an elastomeric ring of a specified material.

Pipe Thread Connectors -

NPT - National Pipe Taper. Pipe thread per ANSI B1.20.1

NPTF - National Pipe Tapered for Fuels. (Same as above except dry-seal per ANSI B1.20.3)

NPSH - National Pipe Straight Hose per ANSI B1.20.7

NPSM - National Pipe Straight Mechanical. Straight thread per ANSI B1.20.1

NPSL - National Pipe Straight Loose fit per ANSI B1.20.1

BSPP, BSPT - British Standard Pipe, Parallel, British Standard Pipe Taper. BS21

Quick Connect

Connector - a connector designed to quickly connect and disconnect. These connectors come in many styles and types.

Tube Connector - a hose connector of which the mating end conforms to a tube diameter. The mate or male end of a compression connector.

Flammable gases/liquid/media: a flammable gas, including liquefied gas, is one having a closed cup flash point below +100°F (+37.8°C) and a vapor pressure greater than 25 psi. (174.2 KPa).

flow rate: a volume of media being conveyed in a given time period.

fluid: a gas or liquid medium.

G:

GPM: gallons per minute.

H:

heat resistance: the property or ability to resist the deteriorating effects of elevated temperatures.

hose: a flexible conduit consisting of a tube, reinforcement, and usually an outer cover.

hydrostatic testing: the use of liquid pressure to test a hose or hose assembly for leakage, twisting, and/or hose change-in-length.

Hytre! a DuPont registered trademark.

I:

I.D.: the abbreviation for inside diameter.

identification yarn: a yarn of single or multiple colors, usually embedded in the hose wall, used to identify the manufacturer.

ISO: International Organization for Standardization.

J:

JIC: see connector/coupling-JIC.

K:

kinking: a temporary or permanent distortion of the hose induced by bending beyond the minimum bend radius.

L:

layline: the line of printed information that runs parallel on the side of a manufactured hose giving details such as part number, PSI rating, hose size and manufacturing data.

layer: a single thickness of rubber or fabric between adjacent parts.

loop installation: the assembly is installed in a loop or "U" shape, and is most often used when frequent and/or large amounts of motion are involved.

LPG, LP Gas: the abbreviation for liquefied petroleum gas.

M:

MAWP: see pressure, maximum allowable working.

manufacturer's identification: a code symbol used on or in some hose to indicate the manufacturer.

media, medium: the substance(s) being conveyed through a system.

N:

NAHAD: the abbreviation for the National Association of Hose & Accessories Distributors.

Neoprene: a registered trademark of DuPont.

nipple: the internal member or portion of a hose connector.

nitrile rubber (NB/Buna-N): a family of acrylonitrile elastomers used extensively for industrial hose.

Glossary

Alpha/Numeric

nominal: a size indicator for reference only.

nomograph: a chart used to compare hose size to flow rate to recommended velocity.

non-conductive: the inability to transfer an electrical charge.

NPT/NPTF: abbreviation for national pipe threads. See connector/coupling - Pipe Thread Connectors.

nylon: a family of polyamide materials.

O:

OAL: see overall length

O.D.: the abbreviation for outside diameter.

OE/OEM: original equipment manufacturer.

oil resistance: the ability of the materials to withstand exposure to oil.

oil swell: the change in volume of a rubber article resulting from contact with oil.

operating conditions: the pressure, temperature, motion, and environment to which a hose assembly is subjected.

overall length (OAL): the total length of a hose assembly, which consists of the free hose length plus the length of the coupling(s).

oxidation: the reaction of oxygen on a material, usually evidenced by a change in the appearance or feel of the surface or by a change in physical properties.

ozone cracking: the surface cracks, checks or crazing caused by exposure to an atmosphere containing ozone.

ozone resistance: the ability to withstand the deteriorating effects of ozone (generally cracking).

P:

permanent connector: the type of connector which, once installed, may not be removed for re-use.

permeation: the process of migration of a substance into and through another, usually the movement of a gas into and through a hose material; the rate of permeation is specific to the substance, temperature, pressure and the material being permeated.

plating: a material, usually metal, applied to another metal by electroplating, for the purpose of reducing corrosion; typically a more noble metal such as zinc is applied to steel.

ply: an individual layer in hose construction.

polymer: a macromolecular material formed by the chemical combination of monomers, having either the same or different chemical compositions.

pressure: force ÷ unit area. For purposes of this document, refers to PSIG (pounds per square inch gauge).

pressure drop: the measure of pressure reduction or loss over a specific length of hose.

pressure, burst: the pressure at which rupture occurs.

pressure, working: the maximum pressure to which a hose will be subjected, including the momentary surges in pressure, which can occur during service. Abbreviated as WP.

psi (PSI): pounds per square inch.

PTFE: polytetrafluoroethylene, a high molecular weight fluoroplastic polymer with carbon atoms shielded by fluorine atoms having very strong inter atomic bonds, giving it chemical inertness.

Push>Connect:

(Push>Connect Metric, Push>Connect Flow Controls, Push>Connect Plus) A Reusable, easy to assemble connector recommended on compressed air, lubrication, and pneumatic instrumentation applications. Use with approved tubing material.

PVC: polyvinyl chloride. A low cost thermoplastic material typically used in the manufacture of industrial hoses. The operating temperature range is -500°F to +1750°F (-295.5°C to +954.4°C).

Q:

Quick>Connect: A reusable easy to assemble air brake connector used on NT100 series tubing. This connector meets D.O.T. performance requirements.

R:

reinforcement: the strengthening members, consisting of either fabric, cord, and/or metal, of a hose. See ply.

reusable connector/coupling: see connector/coupling, Field Attachable Connectors.

S:

SAE: Society of Automotive Engineers.

shank: that portion of a connector, which is inserted into the bore of a hose.

specification: a document setting forth pertinent details of a product.

spring guard: a helically wound component applied internally or externally to a hose assembly, used for strain relief, abrasion resistance, collapse resistance.

standard: a document, or an object for physical comparison, for defining product characteristics, products, or processes, prepared by a consensus of a properly con-

stituted group of those substantially affected and having the qualifications to prepare the standard for use.

stem: see nipple.

surge (spike): a rapid and transient rise in pressure.

swelling: an increase in volume or linear dimension of a specimen immersed in liquid or exposed to a vapor.

T:

Teflon: a registered trademark of E.I. DuPont. See PTFE, FEP and PFA.

tube: the innermost continuous all-rubber or plastic element of a hose.

tube connector: see connector/coupling-Tube.

tubing: a non-reinforced, homogeneous conduit, generally of circular cross-section.

V:

vacuum resistance: the measure of a hoses ability to resist negative gauge pressure.

vibration: amplitude motion occurring at a given frequency.

viscosity: the resistance of a material to flow.

W:

weathering: the surface deterioration of a hose cover during outdoor exposure, as shown by checking, cracking, crazing and chalking.

working temperature: the temperature range of the application, may include the temperature of the fluid conveyed or the environmental conditions the assembly is exposed to in use.

WP: the abbreviation for working pressure.

The preceding Glossary of Terms, as utilized in the hose industry, includes some definitions from The Hose Handbook, published by the Rubber Manufacturers Association.

Index

Alpha/Numeric

A55SCUx	69	C9200	122	MTP16006	29	T-345	140
A555	104	C9240	122	MTP16008	29	T-345K	140
A555P	106	CA-631	144	MTP16010	29	T-346x	140
A555S	104	CA-63260	143	MTP16012	29	T-372	139
A556P	106	CB-63x	142	NT10002	27	T-373	139
A557MCUx	69	CD-15	142	NT10025	27	T-374	139
A557SCUx	69	CD-150	142	NT10003	27	T-375	139
A655	104	CL-490	141	NT10004	27	T-376	139
A655S	104	CL-491	141	NT10005	27	T-378	139
A660	104	CL-492	141	NT10006	27	T-1010	139
A664	113	CL-493	141	NT10008	27	T-1022	140
A690	104	CL-494	141	NT10010	27	T-1422R	140
A690P	166	CL-496	141	NT10012	27	T-1430	137
A690S	104	CL-497	141	PC-48	145	T-3710	139
A694	113	CL-498	141	PT20004	27	T-3712	139
A694S	113	CL-499	141	PT20044	27	T-3716	139
A735	104	CL-500	141	PT20005	27	TA-1002	136
A6690	104	CL-501	141	PT20006	27	TP16002	29
A6690S	104	CL-503	141	PT20008	27	TP16025	29
A6754	113	FC-16x	142	PT20010	27	TP16004	29
A6754S	113	FC-161	144	PT20012	27	TP16005	29
A6755	104	FF90587	115	PT20016	27	TP16006	29
A6755S	104	FF90588	115	PT23002	28	TP16008	29
A6759	113	FF90589	115	PT23003	28	W1206	136
A6760	104	FF90590	118	PT23004	28	W1212	136
A6760P	106	FF90591	118	PT23005	28	W1512	136
A6760S	104	FF90592	118	PT23006	28	W15310	94 & 112
A6763	104	FF90593	118	PT23008	28	W20332	94 & 113
A6763S	104	FF90594	118	PT24004	28	5X6 PB	141
A6764	113	FF90595	117	PT24044	28	6X10 PB	141
A6764S	113	FF90596	117	PT24005	28	8X12 PB	141
A6765	104	FF90597	116	PT24006	28	39x	37
A6765S	104	FF90598	116	PT24008	28	40x	37
A6769	113	FS-500	141	PT24010	28	41x	37
A6769S	113	FS-504	141	PT24012	28	42x	37
A6770	104	FS-800	141	PT24016	28	43x	38
A6774	113	FS-900	141	T-100	139	44x	40
A6775	104	FS-1000	141	T-104	139	45x	40
A6775S	104	FS-2100	141	T-105	139	46x	38
A6779	113	FS-3300	141	T-106	139	48x	38
A6779S	113	FT1341	136	T-107	139	49x	39
A6845	104	FT1356	138	T-108	139	50x	39
A6845S	104	FT1356-2-1	138	T-138	138	51x	40
A6855	104	FT1600	142	T-138B	138	54x	38
A6855S	104	FT1601	142	T-150	137 & 140	55x	39
A6860	104	FT1602	142	T-191	138	56x	40
A6860P	106	FT1605	142	T-191B	138	59x	122
A6860S	104	FT1607	144	T-200	140	60x	42
B735	104	FT1608	144	T-210	140	61x	42
C-15x	142	FT1613	145	T-220	140	62x	43
C-63x	142	M41157	122	T-221	140	63x	44

Index

Alpha/Numeric

64x	46	230	107	1077x	75	1202x	54
65x	45	252x	33	1078x	73	1260x	54
66x	44	270	107	1079x	73	1261x	54
68x	43	302x	32 & 125	1100x-MM	135	1262x	54
69x	45	320	106	1100x-PP	135	1264x	56
70x	45	325	106	1105x	59	1266x	55
71x	46	330	106	1105x-M	64	1268x	55
72x	46	352x	33	1107x	60	1269x	56
74x	44	402x	34	1107x-M	65	1270x	56
76x	46	452x	34	1108x	61	1271x	56
100x	32	502x	34	1108x-M	65	1272x	56
105x	123 & 32	530	106	1109x	59	1274x	55
108	107	537	113	1109x-M	64	1340	94 & 101
110	111	601x	49	1110x	37	1341	94 & 101
111	111	602x	35	1129x	59	1342	94 & 101
112	111	611x	49	1129x-MRP	64	1343	94 & 101
113	111	621x	50	1150x-PP	135	1344	93 & 101
114	111	630	106	1161x	59	1345	93 & 101
115	111	631x	50	1161x-M	64	1346	93 & 101
116	111	632	113	1162x	60	1351	93 & 101
117	111	641x	52	1162x-M	64	1360x	91
118	111	651x	51	1164x	62	1361x	91
119	111	652x	35	1164x-M	67	1362x	91
120	108	661x	50	1165x	61	1364x	93
121	111	681x	50	1165x-M	66	1366x	92
122	111	691x	51	1166x	61	1368x	91
123	111	695	106	1166x-M	65	1369x	92
124	111	700	106	1168Px	70	1369x-L	92
125	111	701x	51	1168x	61	1371x	93
126	111	702	113	1168x-M	65	1372x	93
127	111	702x	35	1168x-MM	65	1380x	92
128	111	703	113	1169Px	71	1408	119
130	107	705	108	1169x-5	62	1410	119
131x	32	711x	52	1169x	62	1421-7	109
135	107	721x	52	1169x-M	66	1421-18	109
140	107	741x	51	1169x-MPTS	66	1421-24	109
145	94 & 107	752x	35	1169x-SMM5	66	1421-32	109
150	108	0102x	43 & 49	1171Px	71	1421-60	109
162x	43	1062x	73	1171x-M	67	1421-60A	109
163x	44	1064x	75	1171x-S	62	1422	109
164x	46	1065x	74	1172Px	71	1423	109
165x	45	1066x	73	1172x-M	67	1424A	108
166x	44	1067x	74	1172x-S	63	1425A	108
168x	43	1068x	73	1172x-MM5	67	1426A	108
169x	45	1069x	74	1174x	60	1427	109
170x	45	1070x	74	1174x-M	65	1428	119
171x	46	1071x	75	1180x	60	1429	119
172x	46	1072x	75	1180x-M	64	1432	119
174x	44	1073x	73	1181x	63	1433	109
185	107	1074	123	1183x	63	1437	120
190	107	1074x	74	1184x	63	1439	120
202x	33	1075x	75	1185x	63	1440	120

Index

Alpha/Numeric

1441	123	1568Px	128	1901	134	3326x	100
1442	124	1569x	130	1902	134	3327x	100
1443	124	1569Px	130	1903	134	3328x	100
1444	120	1570x	130	1906	134	3329x	100
1445	120	1570Px	130	1907	134	3330x	100
1446	120	1571x	132	1908	134	3331x	100
1447	120	1571Px	132	1911	134	3350x	101
1451	109	1572x	131	1912	134	3400x	101
1460x	85	1572Px	131	1913	134	3500x	102
1461x	85	1574x	128	1914	134	3600x	102
1462x	85	1574Px	128	1915	134	3700x	102
1464x	88	1584x	132	1916	134	3750x	102
1465x	87	1584Px	132	1917	134	3950x	102
1466x	86	1596	121	1918	134	6100x	96
1468x	86	1611x	43 & 49	1920	134	6200x	96
1469x	87	1621x	50	1921	134	6400x	96
1469x-L	87	1631x	50	1922	134	6600	108
1470x	87	1641x	52	1923	134	6660	109
1471x	88	1651x	51	1924	134	6700	106
1472x	88	1661x	50	1925	134	6703	106
1474x	86	1681x	50	1927	134	6707	114
1477x	88	1691x	51	1928	134	6708	114
1480x	86	1701x	51	1929	134	6709	114
1482x	89	1711x	52	1930	134	6715	105
1484x	89	1721x	52	1931	134	6719	112
1485x	89	1741x	51	1932	134	6724	112
1502x	133	1800Kx	83	1933	134	6729	112
1502Px	133	1800T	83	1935	134	6737	114
1512	99 & 120	1800TRK	83	1936	134	6747	114
1513	121	1829x.	83	1937	134	6748	114
1514	121	1861x	78	1938	134	6749	114
1518	33 & 39 & 121	1862x	78	1939	134	6783	108
1521	39 & 1	1864x	81	1940	134	6788	107
1522	33 & 39 & 121	1865x	80	1942	134	6800	105
1529x	133	1866x	79	1943	134	6804	114
1529Px	133	1868x	79	1944	134	6805	105
1531x	133	1869x	80	1945	134	6809	114
1553	33 & 39 & 121	1869x-L	80	1946	134	6810	105
1554	33 & 39 & 121	1869x-S	81	1948	134	6815	105
1561x	132	1870x	81	1949	134	6820	105
1561Px	132	1871x	81	2030x	42 & 48	6824	113
1562x	129	1871x-S	82	3129x	98	6825	105
1562Px	129	1872x	82	3150x	98	6828	114
1563	33 & 39 & 121	1872x-S	82	3151x	98	6829	113
1564x	131	1873x	78	3152x	98	6891	112
1564Px	131	1874x	78	3153x	98	6892	112
1565x	131	1877x	82	3200x	98	6893	112
1565Px	131	1880x	79	3220x	99	7502	110
1566x	129	1880x-S	80	3250x	99	7504	110
1566Px	129	1883x	83	3300x	99	7506	110
1568x	128	1900	134	3325x	100	7508	110

Index

Alpha/Numeric

7509	110	7829	123	7910	123	7936	124
7709	124	7896x	123 & 32	7911	123	7937	124
7727	123	7897	123	7912	123	7940	125
7732	123	7898	124	7913	123	7941	125
7765	124	7900	124	7914	124	7970	124
7771	123	7901	124	7915	122 & 123	7975	124
7805	124	7904	124	7916	122 & 123	7977	122
7812	124	7905	124	7917	123	7978	122
7817	123	7906	124	7933	124		
7818	123	7908	123	7934A	125		
7828	123	7909	123	7935	124		

Warranty

Eaton Hydraulics warranty policy is located at www.hydraulics.eaton.com/warranty

Eaton
14615 Lone Oak Road
Eden Prairie, MN 55344
USA
Tel: 952 937-9800
Fax: 952 974-7722
www.hydraulics.eaton.com

Eaton
20 Rosamond Road
Footscray
Victoria 3011
Australia
Tel: (61) 3 9319 8222
Fax: (61) 3 9318 5714

Eaton
Dr.-Reckeweg-Str. 1
D-76532 Baden-Baden
Germany
Tel: (49) 7221 682-0
Fax: (49) 7221 682-788

