

Subplates and Connection Plates for Four-Port Directional Valves

ISO 4401, 02/03/05/07/08

General Description

This range of subplates and auxiliary connection plates offers an economical way of mounting the range of Vickers directional control valves and associated stackable auxiliary valves.

The 2 to 6 multi-station subplates, available on sizes 02 and 03 provide very compact control assemblies when used together with Vickers SystemStak™ valves.

The varied maximum pressure ratings of this current range of subplates, etc., are clearly indicated in the "Schedule of Plates and Subplates" for each size.

Plates having machined O-seal recesses are supplied complete with O-seals.

All Vickers 02 and 03 valves and auxiliary plates are fitted with a location pin to ensure correct orientation of the mounting surfaces.

When a subplate is not used, a machined pad must be provided for the valve mounting. This pad must be flat within 0,01 mm per 100 mm (0.0001" per 1") and smooth within 0,8 μm (32 μin), over the area designated in the appropriate ISO 4401 standard.

Size 02

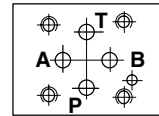

Size 03

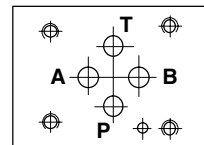

Size 05

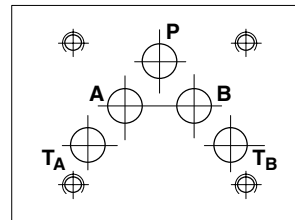

Size 07

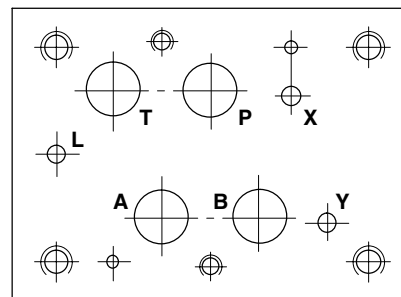

Size 08

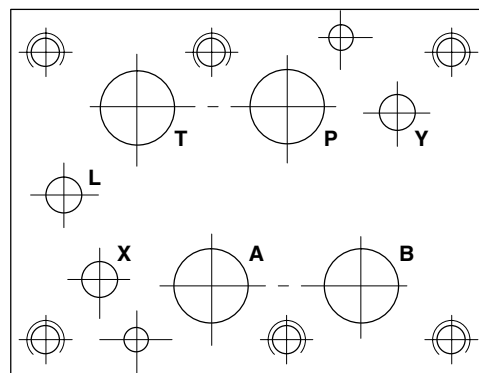

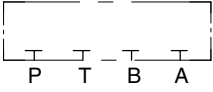

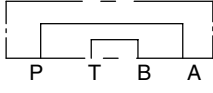

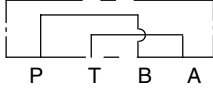

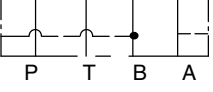

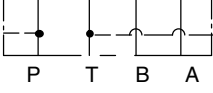

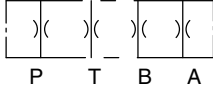

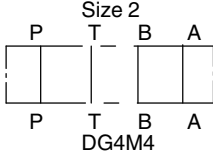

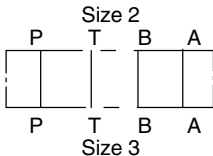



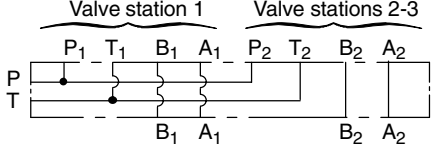



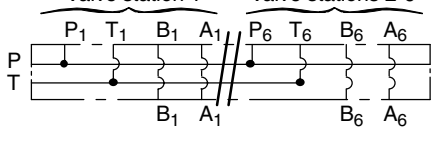







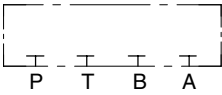

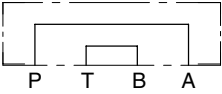

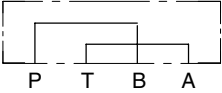

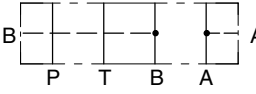

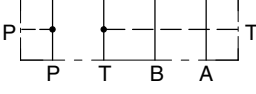

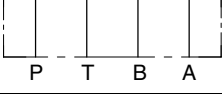

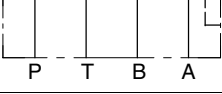

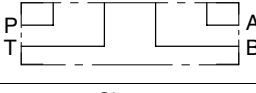
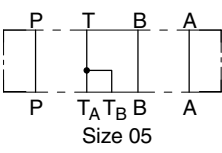

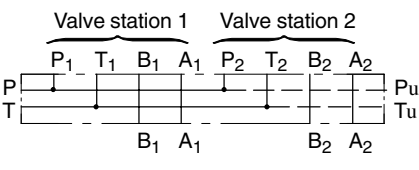

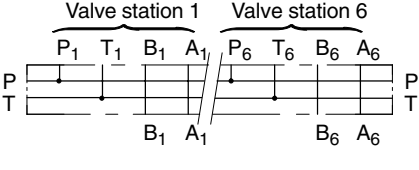

Table of Contents – Size 02

Description and Mass kg (lb)	Functional Symbol	Model Code	Max. Pressure
 Mounting Surface to ISO 4401			
Blanking plate Cast iron 0,24 (0.53)		DGMA-2-B-1* 	250 bar (3600 psi)
Crossover plate P-A; B-T Cast iron 0,21 (0.46)		DGMA-2-C1-1* 	250 bar (3600 psi)
Crossover plate P-B; A-T Cast iron 0,21 (0.46)		DGMA-2-C2-1* 	250 bar (3600 psi)
Tapping plate, ports A and B Cast iron 0,28 (0.62)		DGMA-2-T1-1*-R▲  DGMA-2-T1-1*-S▲	250 bar (3600 psi)
Tapping plate, ports P and T Cast iron 0,28 (0.62)		DGMA-2-T2-1*-R▲  DGMA-2-T2-1*-S▲	250 bar (3600 psi)
Orifice plate Cast iron 0,12 (0.27)		DGOM-2-1*-R▲ 	250 bar (3600 psi)
Adaptor plate, DG4M4 to size 02 Cast iron 0,6 (1.2)		DGAM-2-4-10-R▲  DGAM-2-4-10-S▲	250 bar (3600 psi)
Adaptor plate, size 03 to 02 Cast iron 0,43 (0.95)		DGAM-2-3-1*-R▲  DGAM-2-3-1*-S▲	250 bar (3600 psi)
Single-station subplate; side ports P, T, A, B Aluminium 0,13 (0.29)		DGMS-2-1E-1*-R▲  DGMS-2-1E-1*-S▲	250 bar (3600 psi)
Multi-station subplate/manifold; side ports P, T, A ₁ , B ₁ , A ₂ , B ₂ , etc. 2-station Aluminium 1,36 (3.0) 3-station Aluminium 1,85 (4.1)		DGMS-2-2E-1*-R▲  DGMS-2-2E-1*-S▲  DGMS-2-3E-1*-R▲  DGMS-2-3E-1*-S▲	250 bar (3600 psi)
Multi-station subplate/manifold; side ports P, T, A ₁ , B ₁ , A ₂ , B ₂ , etc. 4-station Aluminium 2,36 (5.2) 5-station Aluminium 2,87 (6.3) 6-station Aluminium 3,37 (7.4)		DGMS-2-4E-1*-R▲  DGMS-2-4E-1*-S▲  DGMS-2-5E-1*-R▲  DGMS-2-5E-1*-S▲  DGMS-2-6E-1*-R▲  DGMS-2-6E-1*-S▲	250 bar (3600 psi)

* Design number subject to change. No change of installation dimensions for design numbers 10 to 19 or 21 to 29 inclusive.

▲ "S" suffix = SAE/UNC ports and/or UNC fixing bolt tappings and/or orifice plugs as appropriate.
"R" = ISO 228 (BSPF) ports and/or metric fixing bolt tappings and/or orifice plugs as appropriate.

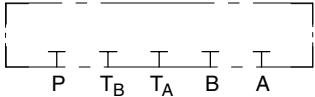

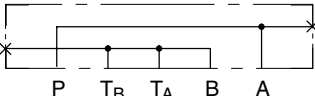

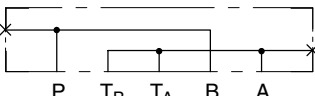

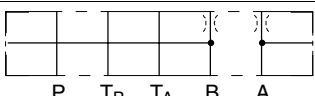

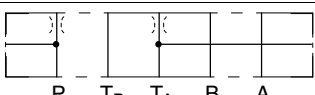

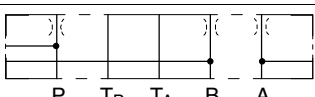

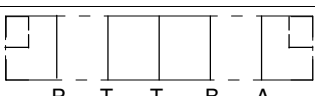

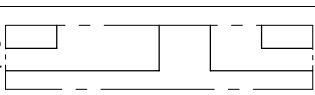

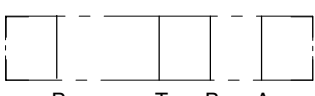

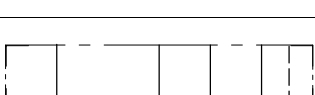

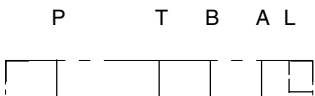

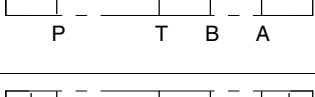



Table of Contents – Size 03

Description and Mass kg (lb)	Functional Symbol	Model Code	Max. Pressure
 Mounting Surface to ISO 4401			
Blanking plate Cast iron 0,5 (1.1)		DGMA-3-B-1* 	350 bar (5000 psi)
Crossover plate P-A; B-T Cast iron 0,5 (1.1)		DGMA-3-C1-1* 	350 bar (5000 psi)
Crossover plate P-B; A-T Cast iron 0,5 (1.1)		DGMA-3-C2-1* 	350 bar (5000 psi)
Tapping plate, ports A and B Cast iron 0,5 (1.1)		DGMA-3-T1-1*-B▲ DGMA-3-T1-2*-S▲ 	350 bar (5000 psi)
Tapping plate, ports P and T Cast iron 0,5 (1.1)		DGMA-3-T2-1*-B▲ DGMA-3-T2-2*-S▲ 	350 bar (5000 psi)
Single-station subplate; rear ports P, T, A, B Cast iron 1,3 (2.9)		DGVM-3-1*-R▲ DGVM-3-1*-S▲ 	250 bar (3600 psi)
Single-station subplate; rear ports P, T, A, B; side port L Cast iron 1,3 (2.9)		KDGMV-3-1*-R▲ KDGMV-3-676803-1* (SAE/UNF ports) 	250 bar (3600 psi)
Single-station subplate; side ports P, T, A, B Cast iron 1,3 (2.9)		DGMS-3-1E-1*-R▲ DGMS-3-1E(Y)-1*-S ▲	250 bar (3600 psi)
Adaptor, size 05 to 03 Cast iron 0,6 (1.3)		DGAM-3-01-1*-R▲  DGAM-3-01-1* (UNC valve mounting bolts)	210 bar (3000 psi)
Multi-station subplate/manifold; side ports P, T, A ₁ , B ₁ , A ₂ , B ₂ , etc. 2-station Cast iron 4,0 (8.8) 3-station Cast iron 5,5 (12.1)		DGMS-3-2E-1*-R▲  DGMS-3-2E(X)-1*-S▲ DGMS-3-3E-1*-R▲ DGMS-3-3E(X)-1*-S▲	250 bar (3600 psi)
Multi-station subplate/manifold; side ports P, T, A ₁ , B ₁ , A ₂ , B ₂ , etc. 4-station Cast iron 7,0 (15.4) 5-station Cast iron 8,5 (18.7) 6-station Cast iron 10,0 (22.0)		DGMS-3-4E-1*-R▲ DGMS-3-4E-1*-S▲ DGMS-3-5E-1*-R▲ DGMS-3-5E-1*-S▲  DGMS-3-6E-1*-R▲ DGMS-3-6E-1*-S▲	250 bar (3600 psi)

* Design number subject to change. No change of installation dimensions for design numbers 10 to 19 or 21 to 29 inclusive.

▲ "S" suffix = SAE/UNC ports and/or UNC fixing bolt tappings and/or orifice plugs as appropriate.
"R" or "B" = ISO 228 (BSPF) ports and/or metric fixing bolt tappings and/or orifice plugs as appropriate.

Table of Contents – Size 05







Description and Mass kg (lb)	Functional Symbol	Model Code	Max. Pressure
 Mounting Surface to ISO 4401			
Blanking plate Cast iron 2,9 (6.4)		DGMA-5-B-1*	 315 bar (4500 psi)
Crossover plate P-A; B-T Cast iron 2,9 (6.4)		DGMA-5-C1-1*	 315 bar (4500 psi)
Crossover plate P-B; A-T Cast iron 2,9 (6.4)		DGMA-5-C2-1*	 315 bar (4500 psi)
Tapping plate, ports A and B Cast iron 0,5 (1.1)		DGMA-5-T1-1*-B▲	 315 bar (4500 psi)
Tapping plate, ports P and T Cast iron 0,5 (1.1)		DGMA-5-T2-1*-B▲	 315 bar (4500 psi)
Tapping plate, ports P, A and B Cast iron 0,5 (1.1)		DGMA-5-T3-1*-B▲	 315 bar (4500 psi)
Adaptor plate for pilot ports X and Y Cast iron 1,4 (3.1)		DGAM-5-1*-R▲ DGAM-5-1*-S▲	 210 bar (3000 psi)
Single-station subplate; side ports P, T, A, B Cast iron 2,0 (4.4)		DGSME-01-2*-T8▲	 210 bar (3000 psi)
Single-station subplate; rear ports P, T, A, B Cast iron 2,0 (4.4)		DGSM-01-2*-T8▲ EDGSM-01-1*-R▲ EDGSM-01X-1*-R▲ EDGSM-01Y-1*-R▲	210 bar (3000 psi)  280 bar (4000 psi)
Single-station subplate; rear ports P, T, A, B; and port L (side or rear) Cast iron 1,3 (2.9)		KDGSM-5-676805-2* (SAE/UNF ports)	 210 bar (3000 psi)
		KDGSM-5-615225-1* (1/2" BSPF ports) KDGS-5-615226-1* (3/4" BSPF ports)	315 bar (4500 psi) 
		EKDGS-01Y-1*-R▲	 280 bar (4000 psi)
Single-station subplate; rear ports P, T, A, B plus X and Y Cast iron 2,0 (4.4)		EDGSM-03-1*-R▲ EDGSM-03X-1*-R▲ EDGSM-03X-1*-S▲	210 bar (3000 psi) 

* Design number subject to change. No change of installation dimensions for design numbers 10 to 19 or 21 to 29 inclusive.

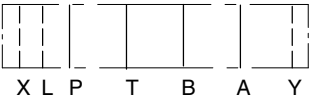
▲ "S" or "T8" suffix = SAE/UNC ports and/or UNC fixing bolt tappings and/or orifice plugs as appropriate.

"R" or "B" = ISO 228 (BSPF) ports and/or metric fixing bolt tappings and/or orifice plugs as appropriate.

Table of Contents – Sizes 07 and 08

Description and Mass kg (lb)	Functional Symbol	Model Code	Max. Pressure
 Mounting Surface to ISO 4401			
Single-station subplate			
Cast iron 3,8 (8.4)		 DGSM-04	210 bar (3000 psi)
Cast iron 3,8 (8.4)		 EDGVM-7X	350 bar (5000 psi)
Cast iron 6,1 (13.4)		 EDGVM-7Y/7Z	350 bar (5000 psi)
Cast iron 5,0 (11)		 DGSM-8	210 bar (3000 psi)
Cast iron 5,0 (11)		 EDGVM-8X	350 bar (5000 psi)
Cast iron 13 (28.6)		 EDGVM-8Y/8Z	350 bar (5000 psi)

Operating Data

Maximum flow rates	No functional limitations: dependent on valves used
Hydraulic fluids	Compatible with all fluids recommended for Vickers sizes 02, 03, 05, 07, and 08 valves
Temperature limits	As for valves, subject to limits: -20°C to 70°C (-4°F to 158°F)
Mounting attitude	No restrictions, other than for valves fitted

Bolt Kits for Mounting Valves

Valve Size	Bolt Threads Metric	Inch	Torque (threads lubricated)
02	M5-6H	#10-24 UNC-2B	5-7 Nm (44-62 lbf in)
03	M5-6H	#10-24 UNC-2B	7-9 Nm (62-79 lbf in)
05	M6-16H	$1/4''$ -20 UNC-2B	9-14 Nm (79-124 lbf in)
07	M10	$3/8''$ -16 UNC-2B	49-59 Nm (434-522 lbf in)
	M6	$1/4''$ -20 UNC-2B	9-14 Nm (79-124 lbf in)
08	M12-6H	$1/2''$ -13 UNC-2B	103-127 Nm (912-1124 lbf in)

*Note: If not using Vickers recommended bolt kits, bolts used should be to ISO 898 class 12.9 or better.
Use lower torque figures only when specified, e.g. for valves with lower maximum pressure rating.
Bolt extenders available for use with size 05 valves cannot be used with size 05 auxiliary plates featured in this catalog.*

Mounting Surfaces to ISO 4401 (Size 02)

Dimensional Tolerances

Dimensional tolerance on interface drawings is $\pm 0,2$ mm (± 0.008 ") except where otherwise stated. ISO 4401 specifies inch conversion to ± 0.01 " .

Conversion from Metric

ISO 4401 gives dimensions in mm. Inch conversions are accurate to 0.01" unless otherwise stated.

Mounting Bolt Tappings

ISO 4401 gives metric thread tappings. Alternative UNC tappings are Vickers recommendations that allow these plates and associated valves to be used up to their recommended maximum pressures, when using Vickers recommended mounting bolt kits, or bolts of an equivalent strength (see catalog 2314 "Fixing Bolt Kits").

It is recommended that Customer's own manifold blocks for UNC bolts should be tapped to the minimum depths given in the footnotes.

Vickers Standard Size 02 Interface

This interface conforms to ISO 4401-02-01-0-94

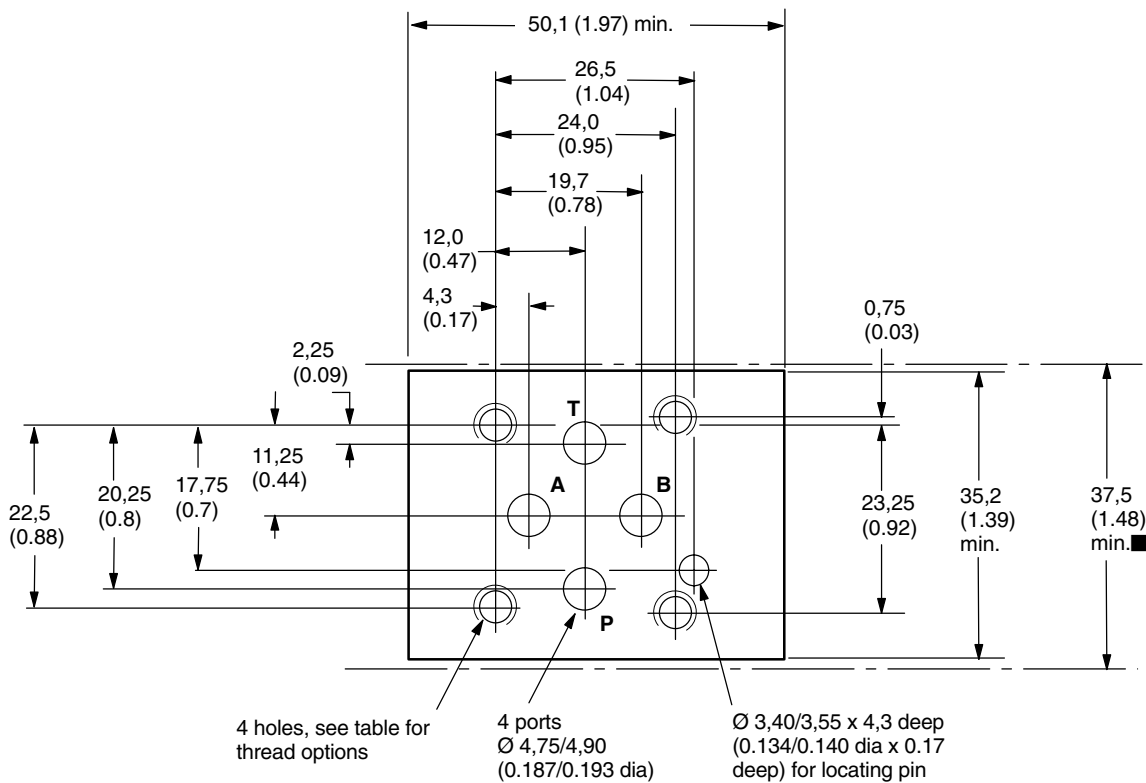

Mounting Bolt Tapping Options

Thread	Min. tapping depth for subplates/manifolds in		
	Steel	Cast iron	Aluminium
Metric			
M5-6H	12,3 (0.484)	12,3 (0.484)	12,3 (0.484)
Inch			
#10-24 UNC-2B	12,6 (0.496)	14,9 (0.587)	14,9 (0.587)

■ This dimension gives the minimum space required for a valve with this mounting surface. The dimension is also the minimum center-to-center pitch of mounting surfaces on a manifold block.

Installation Dimensions in mm (inches) (Size 02)

DGMA-2-B-1* Blanking Plate

3rd angle projection 

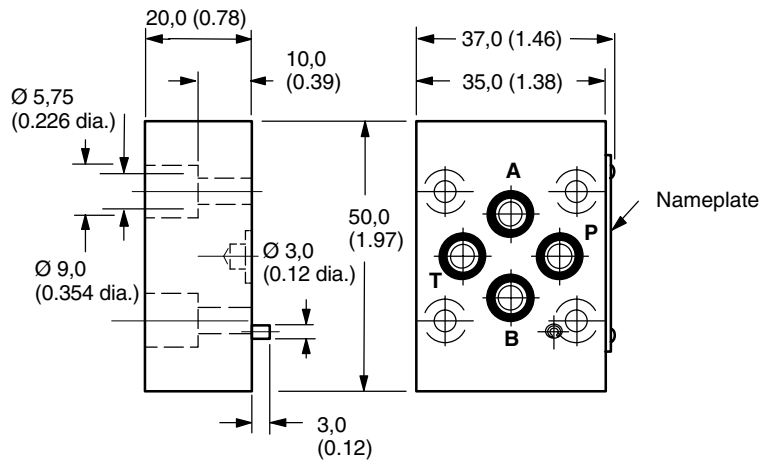
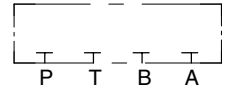

DGMA-2-C*-1* Crossover Plate

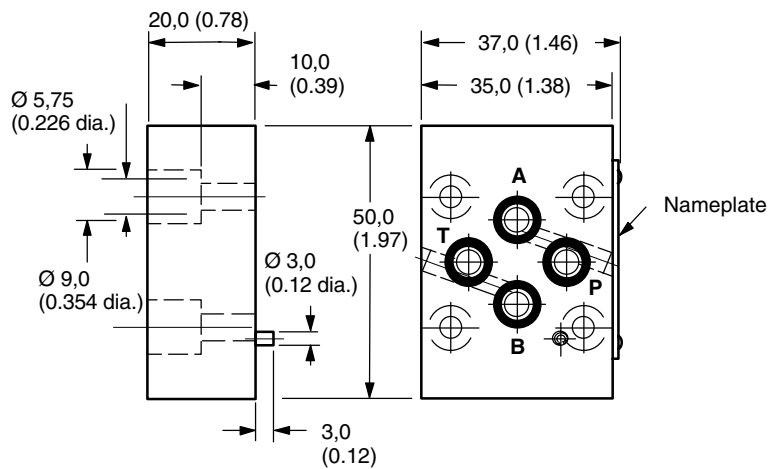
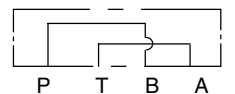
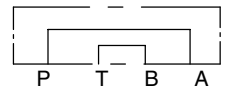

DGMA-2-C1-1*
(P-A, B-T)

DGMA-2-C2-1*
(P-B, A-T)

Installation Dimensions in mm (inches) (Size 02)

ISO 02 Adaptor Plate

DGAM-2-4-10-R

DGAM-2-4-10-S

When replacing a DG4M4, this adaptor plate has been designed in line with our range of subplates and auxiliary plates.

Two versions are offered:

- S – SAE-UNC ports and/or UNC attaching bolt tappings and/or orifice plugs.
- R – ISO 228 (BSPF) ports and/or metric attaching bolt tappings and/or orifice plugs.

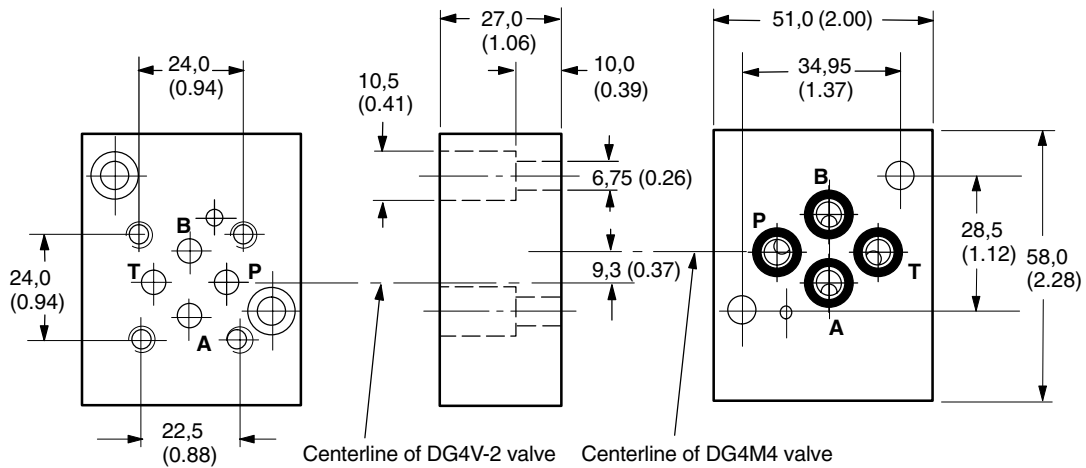

Installation Dimensions in mm (inches) (Size 02)

DGAM-2-3-1*-R (Metric Bolt Tappings)
DGAM-2-3-1*-S (UNC Bolt Tappings)
Adaptor Plate, Size 03 to 02
For pressures up to 250 bar (3600 psi)

Size 02 valves can frequently be used in place of size 03 valves, or generally where the system flow rate is within that of size 02 valves.

The DGAM-2 adaptor plate bolts to an existing size 03 interface and provides a size 02 mounting face for the smaller valve.

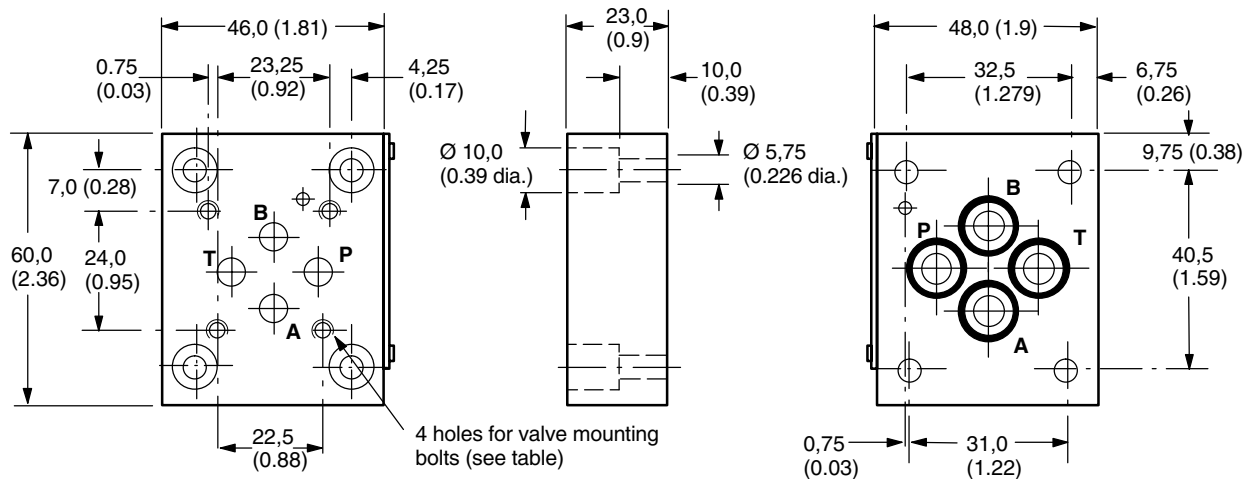
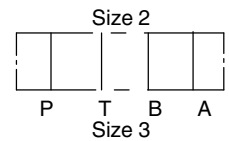

Size 02 Mounting Face

**Size 03 Mounting Face
(ISO 4401 Size 03)**

Model	Valve mounting bolt tappings
DGAM-2-3-1*-R	M5 x 12,3 (0.48) deep
DGAM-2-3-1*-S	#10-24 UNC x 14,9 (0.587) deep

DGMS-2-1E-1*-*
Single-Station Subplate, Side Tapped Ports

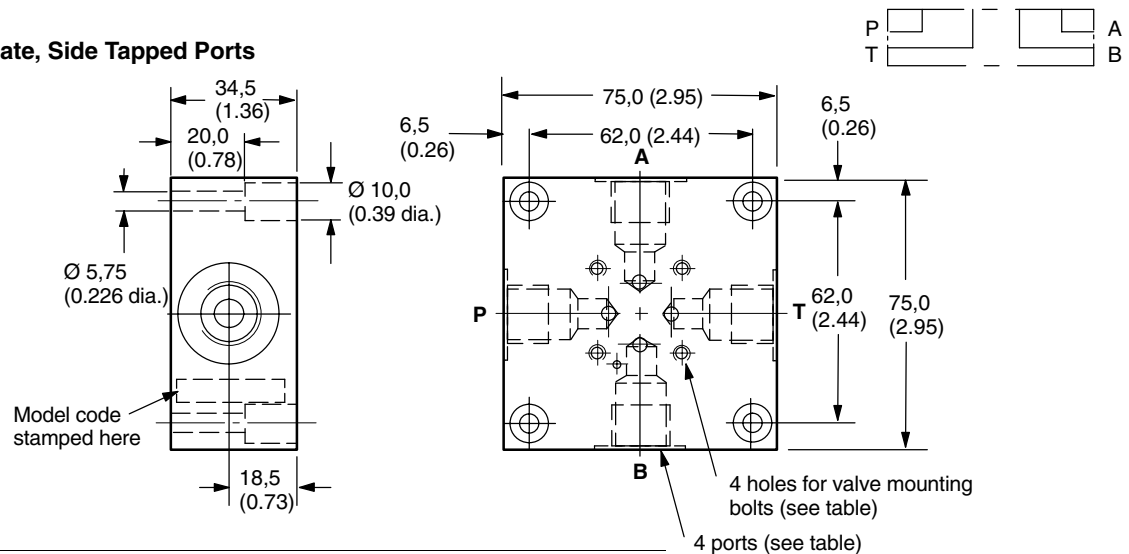

Model	Ports P, A, T, B tappings	Valve mounting bolt tappings
DGMS-2-1E-1*-R	G ³ / ₈ (3/8" BSPF) x 12,0 (0.47) deep	M5 x 12,3 (0.48) deep
DGMS-2-1E-1*-S	3/4" 16 UNF-2B x 14,3 (0.56) deep	#10-24 UNC x 14,9 (0.587) deep

Installation Dimensions in mm (inches) (Size 02)

DGMS-2-*E-1*-* Multi-Station Subplates (4-station model illustrated)

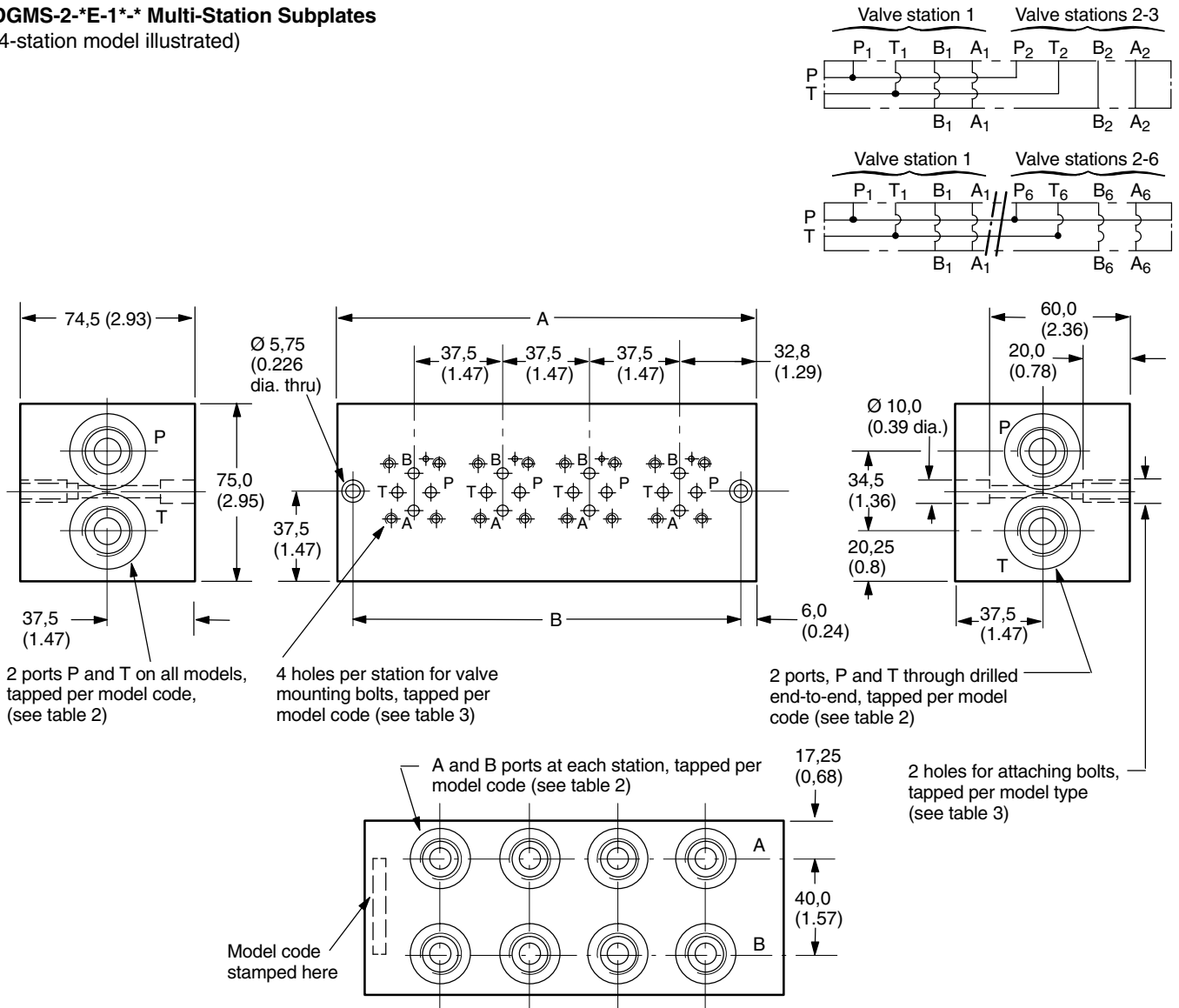

Table 1: Dimensions

Model	A	B
DGMS-2-2E-1*-*	102 (4.02)	90 (3.54)
DGMS-2-3E-1*-*	140 (5.5)	125 (4.92)
DGMS-2-4E-1*-*	178 (7.0)	165 (6.5)
DGMS-2-5E-1*-*	216 (8.5)	200 (7.9)
DGMS-2-6E-1*-*	254 (10.0)	240 (9.45)

Table 2: Port Tappings

Model	Ports P, T	Ports A, B
DGMS-2-1E-1*-R	G ¹ / ₂ (1/2" BSPF)	G ³ / ₈ (3/8" BSPF) x 12,0 (0.47) deep
DGMS-2-1E-1*-S	3/4"-16 UNF-2B	3/4"-16 UNF-2B x 14,3 (0.56) deep

Table 3: Mounting Bolt Tappings

Model	Valve mounting bolts	Manifold rear-mount holes
DGMS-2-1E-1*-R	M5 x 12,3 (0.48) deep	M8 x 1,25-6H
DGMS-2-1E-1*-S	#10-24 UNC x 14,9 deep	5/16"-18 UNC-2B

Installation Dimensions in mm (inches) (Size 03)

DGMA-3-B-1* Blanking Plate

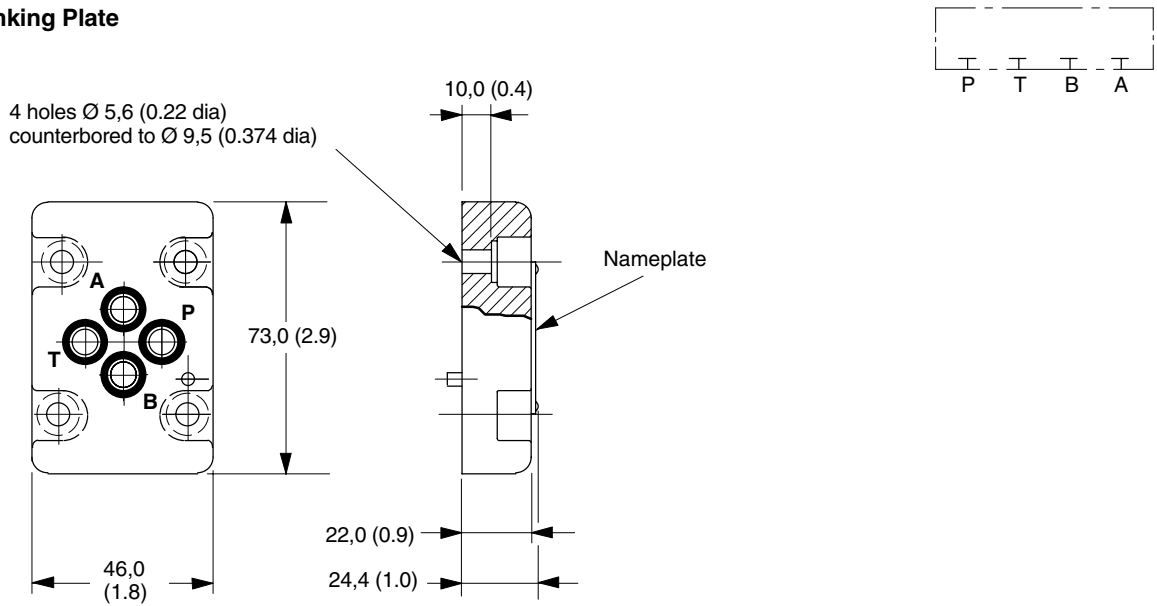

DGMA-3-C*-1* Crossover Plate

The sealing faces shown are for 11-design. For 10-design the sealing face is the same as for DGMA-3-B-1* (transfer passages are drilled). Ensure correct design number is quoted when ordering spare seals.

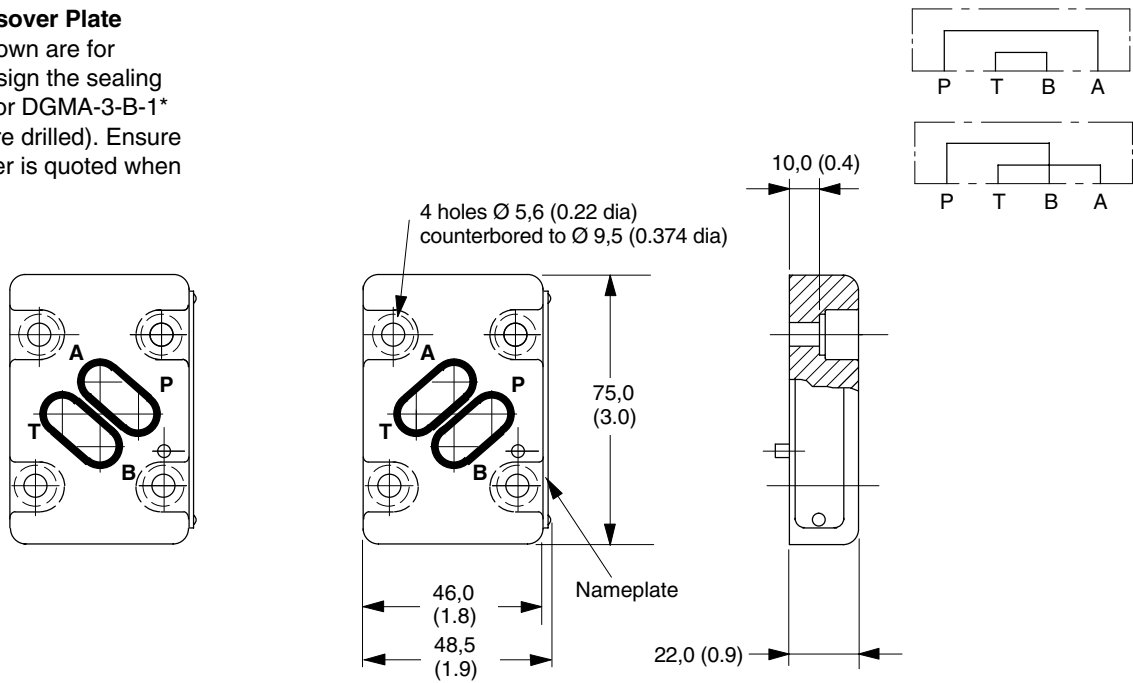

DGMA-3-C1-1*

DGMA-3-C2-1*

Installation Dimensions in mm (inches) (Size 03)

DGMA-3-T1-**-1* Tapping Plate, Ports A and B

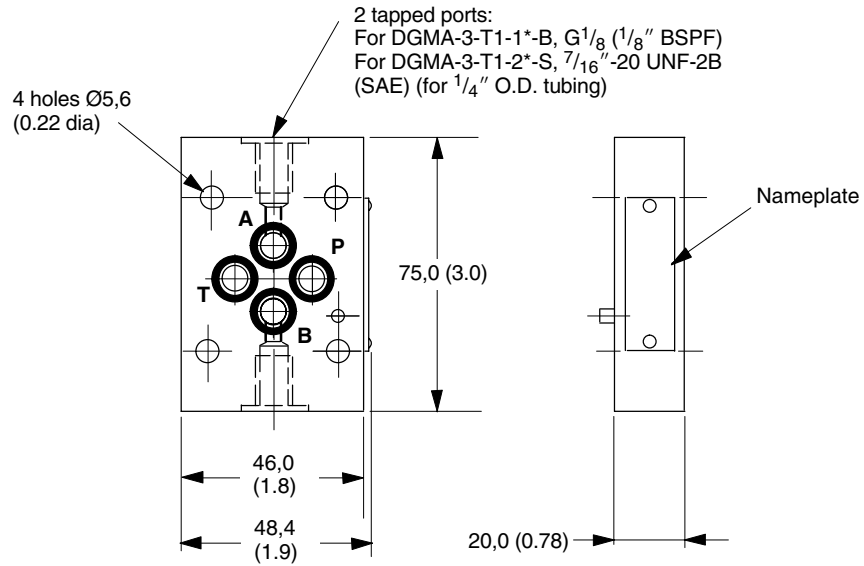
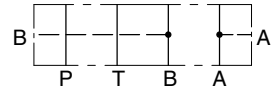

DGMA-3-T2-**-1* Tapping Plate, Ports P and T

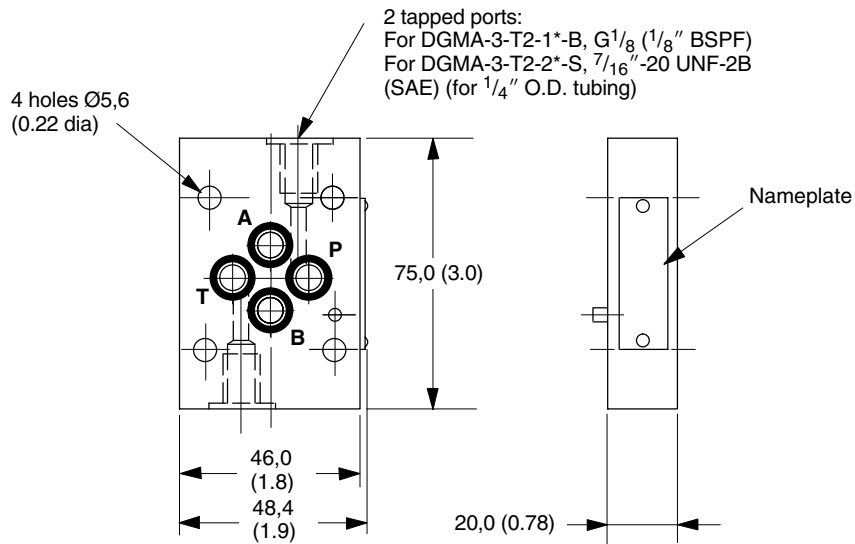
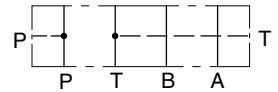

Installation Dimensions in mm (inches) (Size 03)

Single-Station Subplates, Rear and Side Tapped Ports

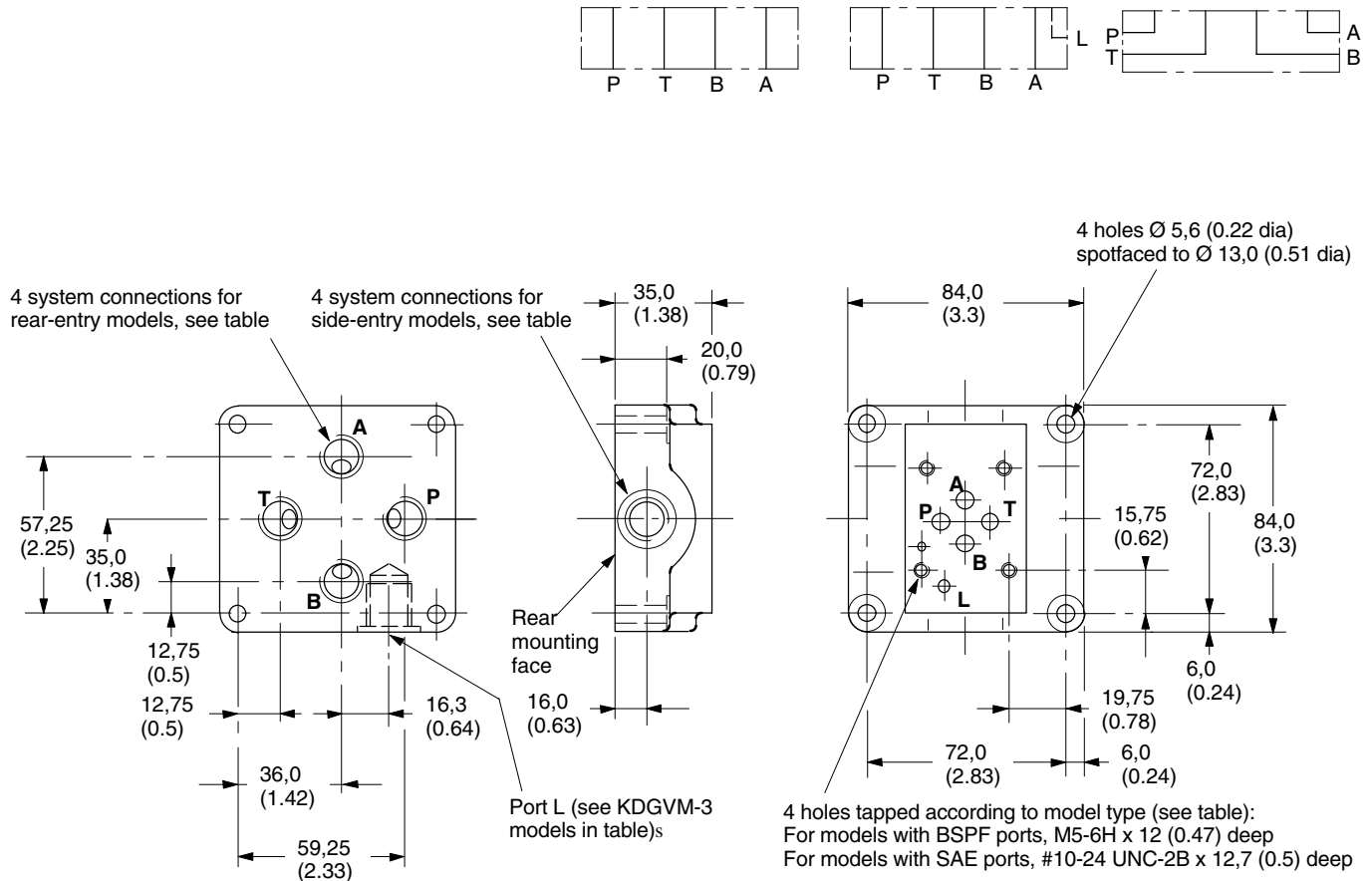

Port Threads

Model	Ports P, T, A, B At rear or side	Port L
BSPF ports/M5 mounting bolts:		
DGVM-3-1*-R	Rear	G ^{3/8} " (3/8" BSPF) x 12,0 (0.47) deep
KDGVM-3-1*-R	Rear	G ^{3/8} " (3/8" BSPF) x 12,0 (0.47) deep
DGMS-3-1E-1*-R	Side	G ^{3/8} " (3/8" BSPF) x 12,0 (0.47) deep
SAE ports/#10-24 UNC mounting bolts:		
DGVM-3-1*-S	Rear	3/4"-16 UNF-2B x 14,3 (0.56) deep (SAE) –
KDGVM-3-676803-1*	Rear	3/4"-16 UNF-2B x 14,3 (0.56) deep (SAE) 7/16"-20 UNF-2B x 11,6 (0.46) deep (SAE)
DGMS-3-1E-1*-S	Side	3/4"-16 UNF-2B x 14,3 (0.56) deep (SAE) –
DGMS-3-1EY-1*-S	Side	5/8"-18 UNF-2B x 12,7 (0.5) deep (SAE) –

s 11,5 (0.45) from rear mounting face to port center line.

Installation Dimensions in mm (inches) (Size 03)

DGAM-3-01-1*-R (Metric Bolt Tappings)
DGAM-3-01-1* (UNC Bolt Tappings)
Adaptors, Size 05 to 03

For pressures up to 210 bar (3000 psi)
 Size 3 valves can frequently be used in place of size 5 valves, typically for pilot control functions, or generally where system flow rate is within that of the size 3 valves.

The DGAM-3-01 adaptor bolts n to an existing size 05 interface and provides a size 03 mounting face for the smaller valve.

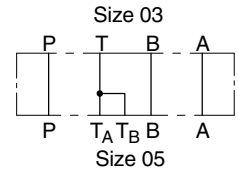

4 holes $\varnothing 7,1$ (0.281 dia), counterbored $\varnothing 11,1$ (0.438 dia) ■

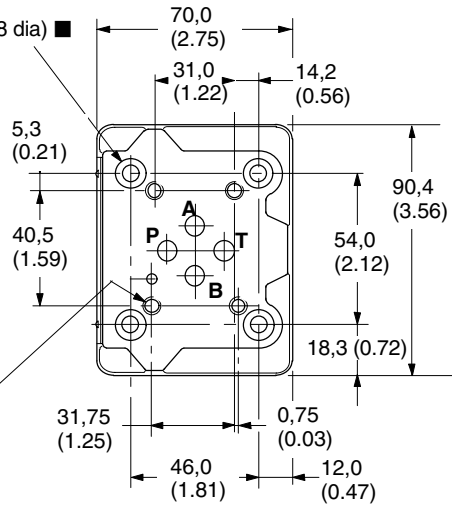

4 holes tapped:
 For DGAM-3-01-1*-R, M5-6H x 12 (0.47) deep
 For DGAM-3-01-1*, #10-24 UNC-2B x 12,7 (0.5) deep

Size 03 Mounting Surface

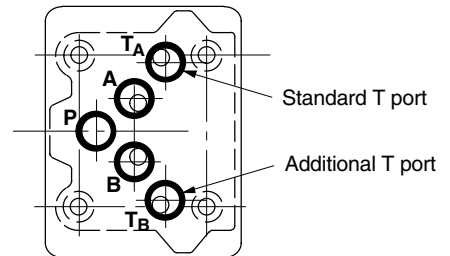
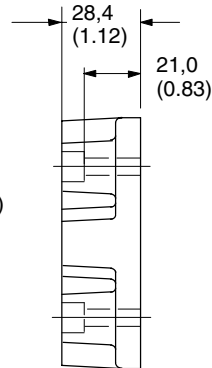

Size 05 Mounting Surface
 Seals included

n Supplied complete with bolts for mounting to size 05 interface:
 M6 bolts with type DGAM-3-01-1*-R
 1/4" -20 UNC bolts with type DGAM-3-01-1*.

Installation Dimensions in mm (inches) (Size 03)

DGMS-3-*E(X)-1*-* Multi-Station Subplates (3-station model illustrated)

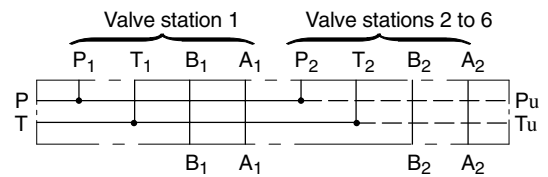

These two ports are:
Present in 4-, 5- and 6-station models
Optional in 2- and 3-station models,
by specifying
DGMS-3-2EX-1*-* or
DGMS-3-3EX-1*-* respectively

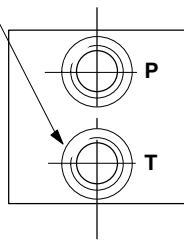

2holes \varnothing 5,6 (0.22 dia)
counterbored to \varnothing 11,1 (0.438 dia)

At each station, 4 holes tapped
according to model type
(see table):
For models with BSPF ports,
M5-6H x 12,0 (0.47) deep.
For models with SAE ports, #10-24
UNC-2B x 12,7 (0.5) deep.

P and T ports tapped according to model type:
For DGMS-3-*E(X)-1*-*R: G $1/2$ " (1/2" BSPF)
For DGMS-3-*E(X)-1*-*S: 3/4"-16 UNF-2B (SAE)

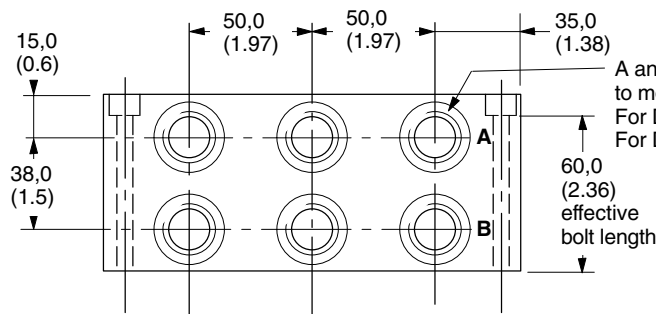
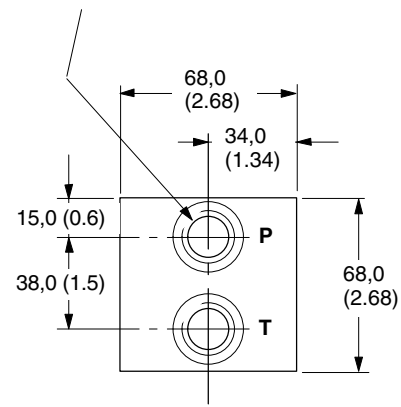
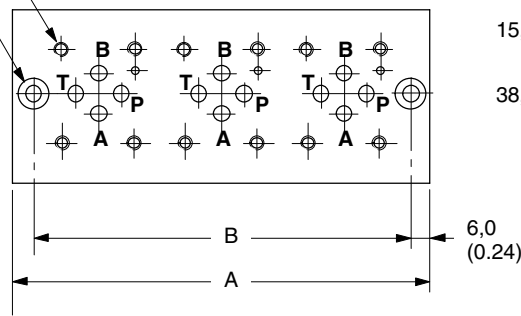

A and B ports at each station tapped according
to model type:
For DGMS-3-*E(X)-1*-*R: G $3/8$ " (3/8" BSPF)
For DGMS-3-*E(X)-1*-*S: 3/4"-16 UNF-2B (SAE)

Model	A	B
DGMS-3-2E(X)-1*-*	121 (4.8)	108 (4.25)
DGMS-3-3E(X)-1*-*	171 (6.8)	158 (6.22)
DGMS-3-4E-1*-*	221 (8.7)	208 (8.19)
DGMS-3-5E-1*-*	271 (10.7)	258 (10.15)
DGMS-3-6E-1*-*	321 (12.7)	308 (12.12)

◆ Through-connection P and T ports on types
DGMS-3-2EX-1*-* and DGMS-3-3EX-1*-*

Mounting Surfaces to ISO 4401 (Size 05)

Vickers Standard Size 05 Interface

This interface conforms to:
 ISO 4401-05-04-0-94
 ANSI/B93.7M (and NFPA) size 05
 CETOP R35H4.2-05
 DIN 24340 Form A10

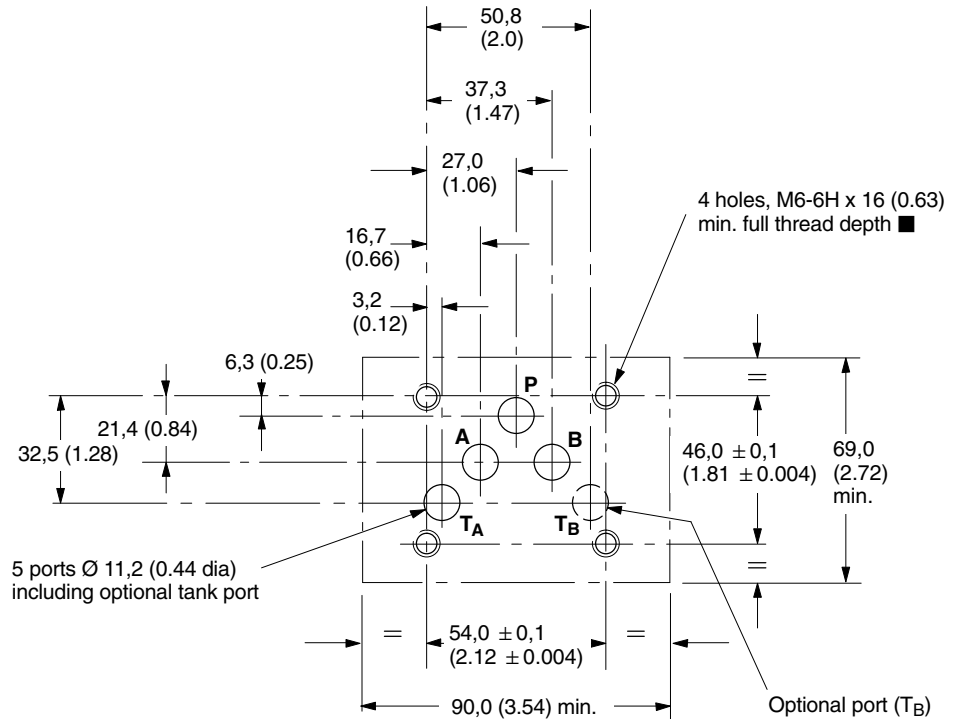

n 1/4"-20 UNC-2B optional.

Interface with Additional Drain Port

The interface conforms to Vickers standard, plus hole "L"

Typically used for proportional and other valves requiring an additional drain port, e.g.:

KFDG4V-5
 KFTG4V-5

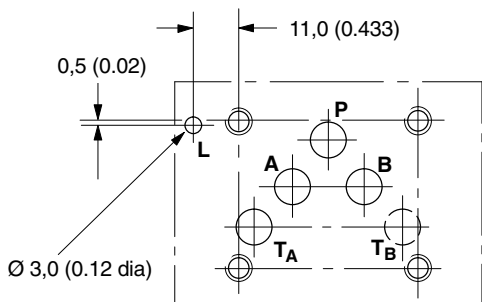

Interface with Additional Pilot Ports X and Y

The interface conforms to Vickers standard, plus holes X and Y
 ISO 4401-05-05-0-94

Typically used for two-stage directional and proportional control valves requiring additional pilot ports, e.g.:

DG5V-5
 KDG5V-5
 KFDG5V-5
 KHDG5V-5

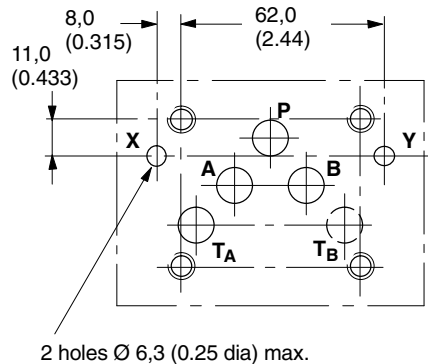

Installation Dimensions in mm (inches) (Size 05)

DGMA-5-B-1* Blanking Plate

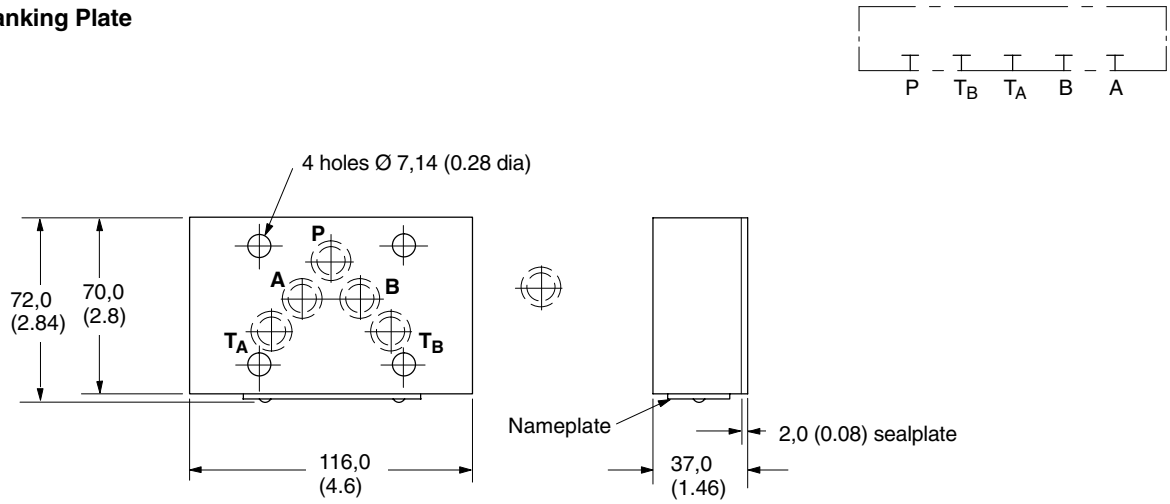

DGMA-5-C*-1* Crossover Plate

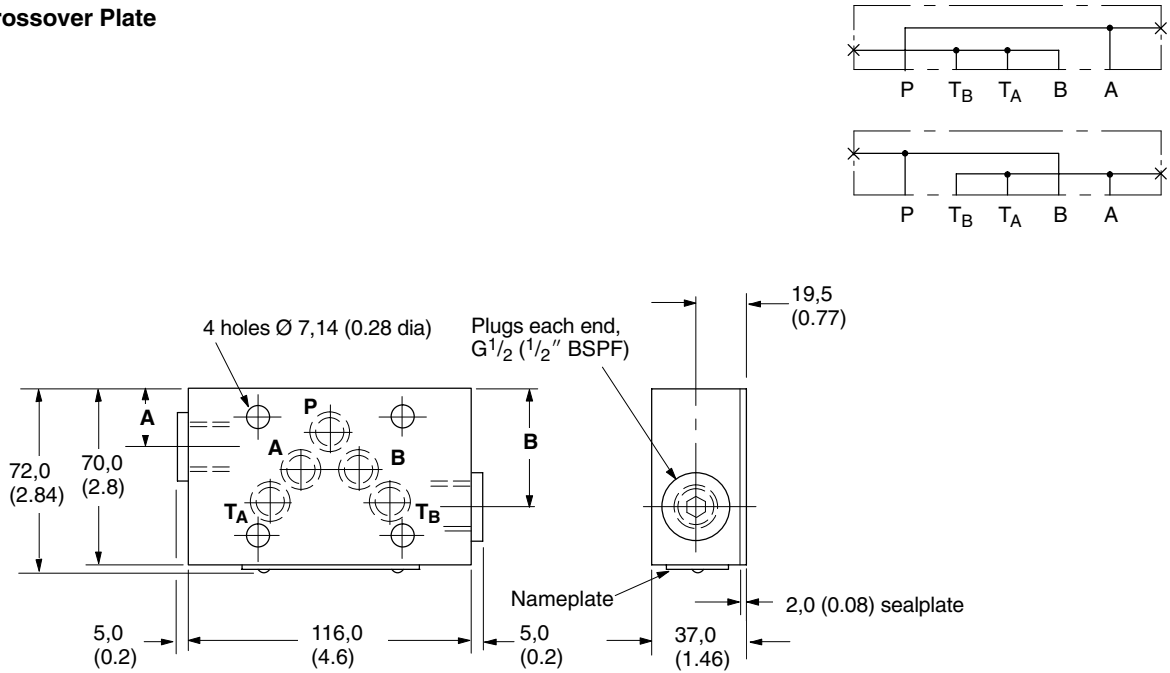

Model	Dimension A	Dimension B
DGMA-5-C1-1*	25,0 (1.0)	40,0 (1.6)
DGMA-5-C2-1*	40,0 (1.6)	25,0 (1.0)

Installation Dimensions in mm (inches) (Size 05)

DGMA-5-T1-1*-B Tapping Plate Ports A and B

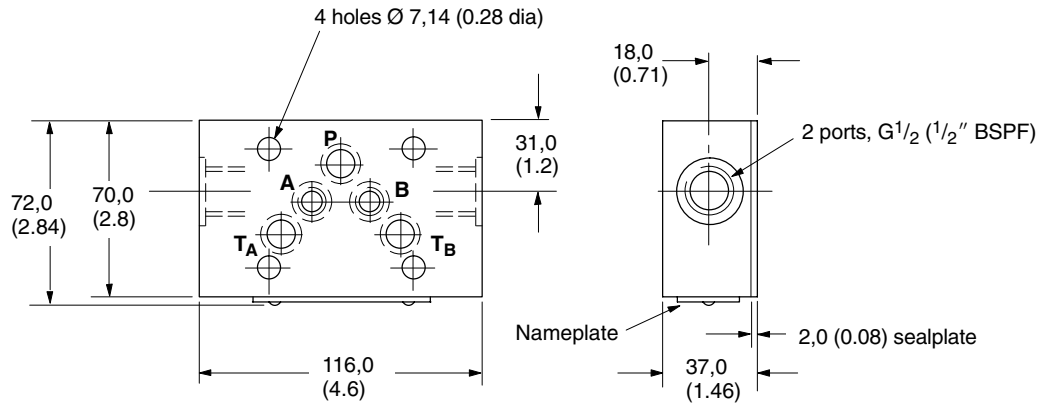
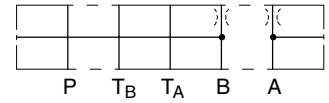

Ports A and B are tapped M12 x 14 (0.55) deep (e.g. for orifice plugs) on opposite face to sealplate.

DGMA-5-T2-1*-B Tapping Plate Ports P and T

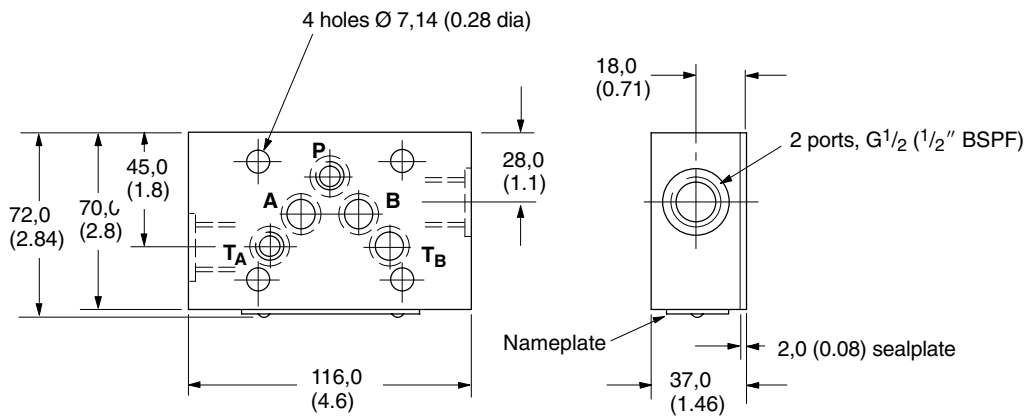
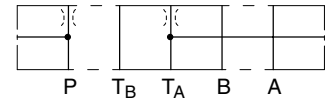

Ports P and T_A are tapped M12 x 14 (0.55) deep (e.g. for orifice plugs) on opposite face to sealplate.

Installation Dimensions in mm (inches) (Size 05)

DGMA-5-T3-1*-B Tapping Plate Ports P, A and B

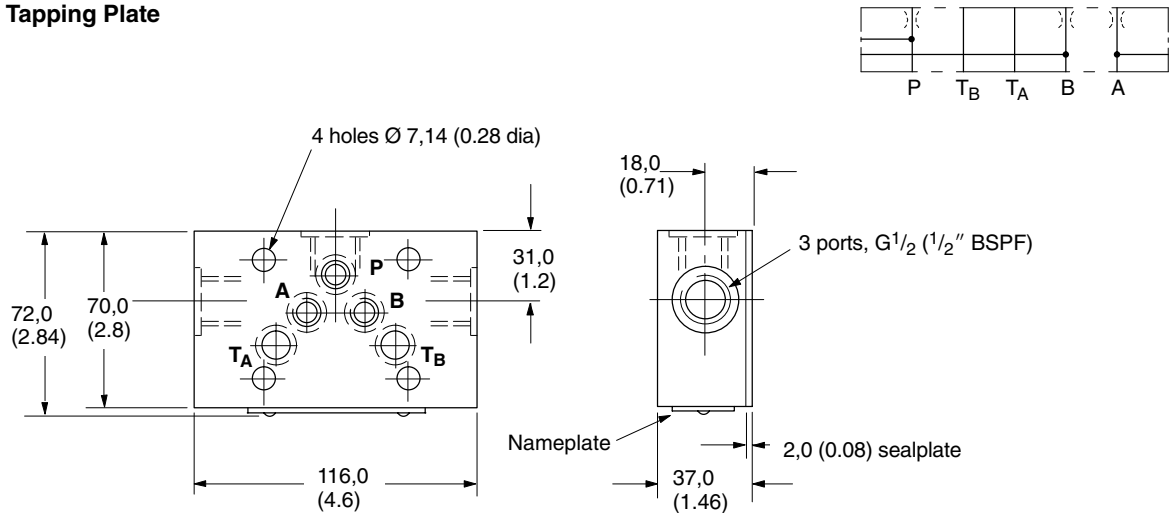

Ports P, A and B are tapped M12 x 14 (0.55) deep (e.g. for orifice plugs) on opposite face to sealplate.

DGAM-5-1*-*-*, X and Y Port Adaptor Plates

Provides for external connections to additional pilot ports X and Y when these ports are not present in subplate/manifold block. Typically used for two-stage directional and proportional valves:

- DG5V-5
- KDG5V-5
- KFDG5V-5
- KHDG5V-5

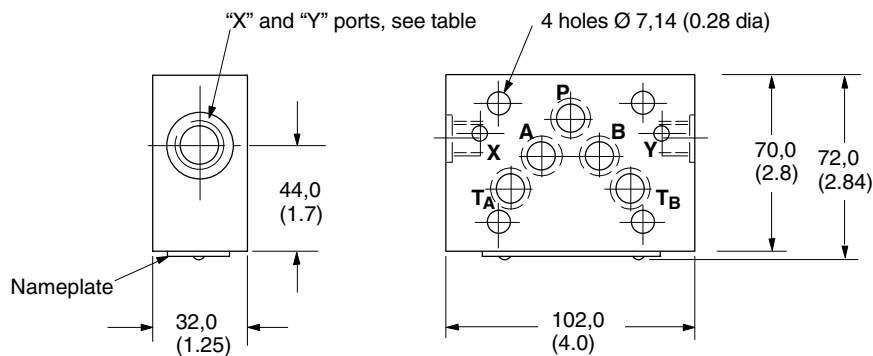

Model	"X" and "Y" port thread
DGAM-5-1*-R	G ¹ / ₄ (1/4" BSPF) x 11,0 (0.43) full thread depth
DGAM-5-1*-S	9/16"-18 UNF x 12,7 (0.5) full thread depth

Installation Dimensions in mm (inches) (Size 05)

Subplates with Rear Ports P, T, A, B Maximum Pressure 210 bar (3000 psi)

Model types: DGSM-01-2*-T8
KDGSM-5-676805-2*
(with rear port L)

Maximum Pressure 280 bar (4000 psi)

Model types: EDGSM-01-1*-R
EDGSM-01X-1*-R
EDGSM-01Y-1*-R
EKDGSM-01Y-1*-R
(with side port L)

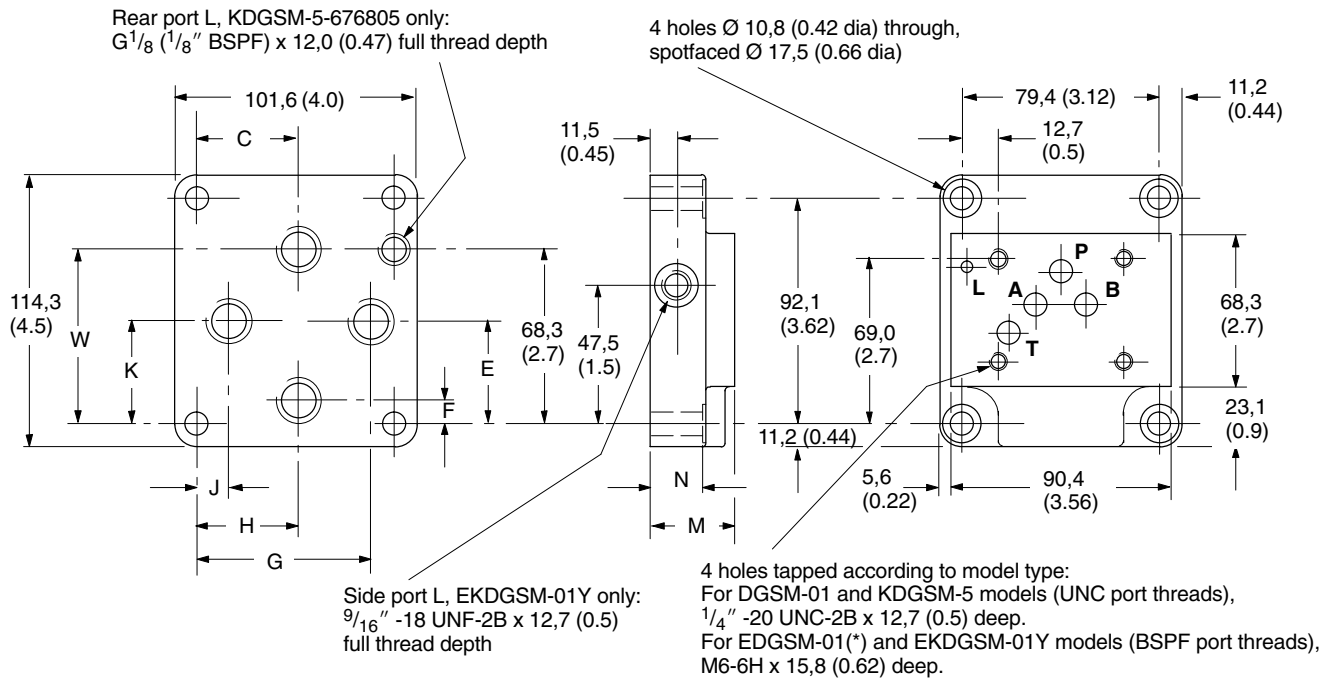
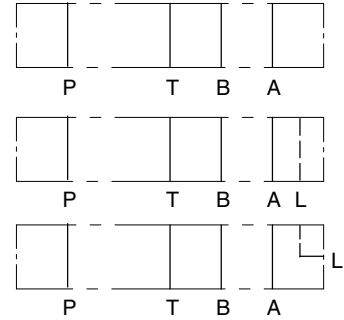

Ports P, T, A, B Threads

Model	Port thread
210 bar (3000 psi)	
DGSM-01-2*-T8 KDGSM-5-676805-2*	3/4"-16 UNF-2B x 14,0 (0.56) full thread depth
280 bar (4000 psi)	
EDGSM-01-1*-R	G ¹ / ₄ (1/4" BSPF) x 12,2 (0.48) full thread depth
EDGSM-01X-1*-R	G ³ / ₈ (3/8" BSPF) x 12,2 (0.48) full thread depth
EDGSM-01Y-1*-R EKDGSM-01Y-1*-R	G ¹ / ₂ (1/2" BSPF) x 15,0 (0.59) full thread depth

Dimensions

Model	C	E	F	G	H	J	K	M	N	W
210 bar (3000 psi)										
DGSM-01-2*-T8 KDGSM-5-676805-2*	45,2 (1.78)	42,1 (1.66)	19,0 (0.75)	68,3 (2.69)	45,2 (1.78)	23,8 (0.94)	42,1 (1.7)	31,8 (1.25)	23,9 (0.94)	57,1 (2.25)
280 bar (4000 psi)										
EDGSM-01-1*-R	39,7 (1.56)	38,1 (1.5)	13,5 (0.53)	65,5 (2.58)	41,7 (1.64)	10,3 (0.41)	40,9 (1.61)	31,8 (1.25)	23,9 (0.94)	62,7 (2.47)
EDGSM-01X-1*-R	39,7 (1.56)	40,5 (1.59)	13,5 (0.53)	67,5 (2.66)	39,7 (1.56)	12,7 (0.5)	40,5 (1.59)	31,8 (1.25)	23,9 (0.94)	68,6 (2.7)
EDGSM-01Y-1*-R	39,7 (1.56)	40,5 (1.59)	9,9 (0.39)	70,6 (2.78)	39,7 (1.56)	10,7 (0.42)	40,5 (1.59)	31,8 (1.25)	28,6 (1.13)	72,6 (2.86)
EKDGSM-01Y-1*-R	39,7 (1.56)	40,5 (1.59)	9,9 (0.39)	70,6 (2.78)	39,7 (1.56)	10,7 (0.42)	40,5 (1.59)	36,5 (1.44)	28,6 (1.13)	72,6 (2.86)

Installation Dimensions in mm (inches) (Size 05)

Subplates with Rear Ports P, T, A, B, L Maximum Pressure 315 bar (4500 psi)

Model types: KDGSM-5-615225-1*
KDGSM-5-615226-1*

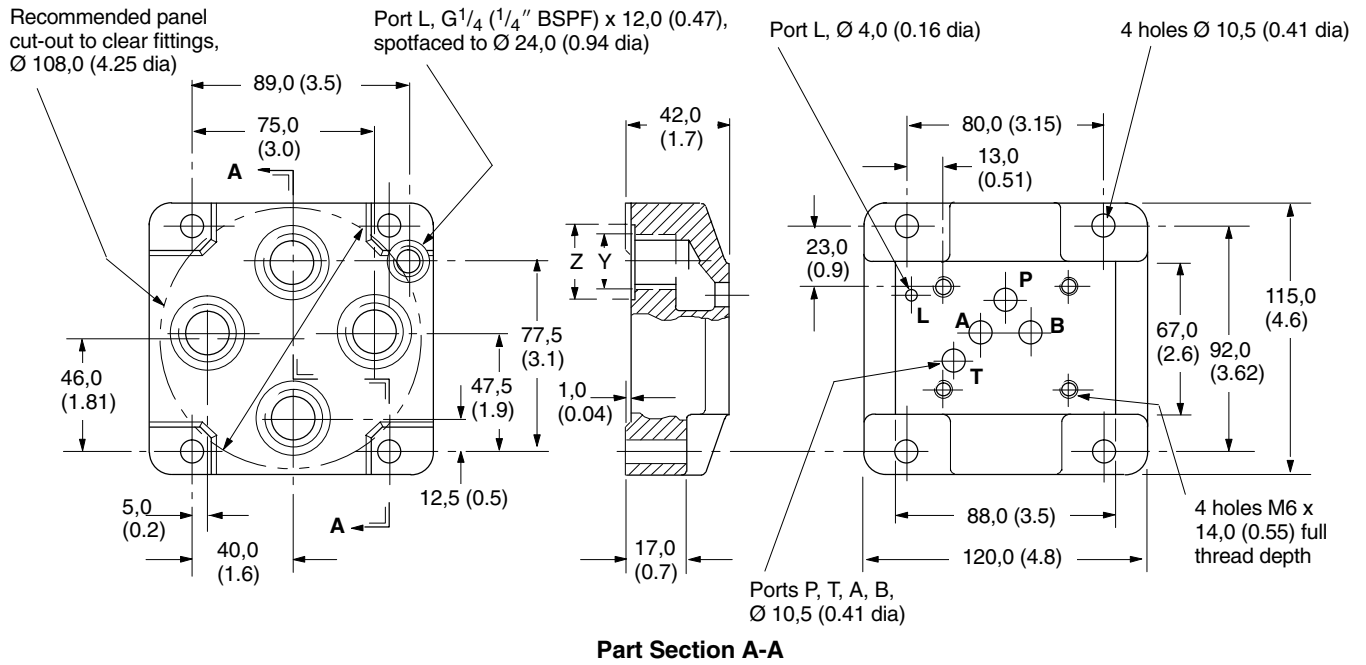

Ports P, T, A, B

Model	Y thread	Z diameter
KDGSM-5-615225-1*	G ¹ / ₂ (1/2" BSPF) x 14,0 (0.55) full thread depth	30,0 (1.18)
KDGSM-5-615226-1*	G ³ / ₄ (3/4" BSPF) x 16,0 (0.63) full thread depth	33,0 (1.3)

Installation Dimensions in mm (inches) (Size 05)

Subplates with Rear Ports P, T, A, B, X, Y Maximum Pressure 210 bar (3000 psi)

Model types: EDGSM-03-1*-R
EDGSM-03X-1*-R
EDGSM-03X-1*-S

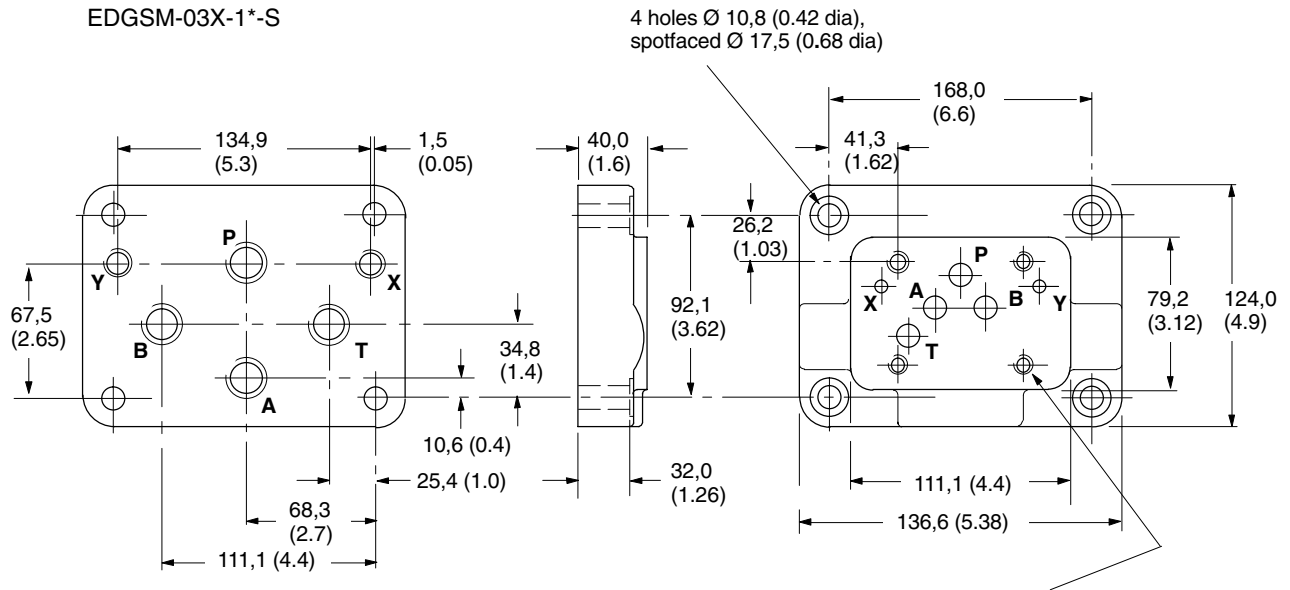

Port Threads

Model	Ports P, T, A, B	Ports X, Y
EDGSM-03-1*-R	G $\frac{1}{2}$ ($\frac{1}{2}$ " BSPF) x 14,0 (0.55)	G $\frac{1}{4}$ ($\frac{1}{4}$ " BSPF) x 12,2 (0.48)
EDGSM-03X-1*-R	full thread depth	full thread depth
EDGSM-03X-1*-S	1 $\frac{1}{16}$ "-12 UN-2B x 16,0 (0.63)	$\frac{9}{16}$ "-18 UNF-2B x 12,7 (0.5)
	full thread depth	full thread depth

Mounting Surfaces to ISO 4401 (Sizes 07 and 08)

Vickers Standard Size 07 Interface

This interface conforms to:

- ISO 4401-07-06-0-94
- ANSI/B93.7M (and NFPA) size 07
- CETOP R35H4.3-07
- DIN 24340 Form A16

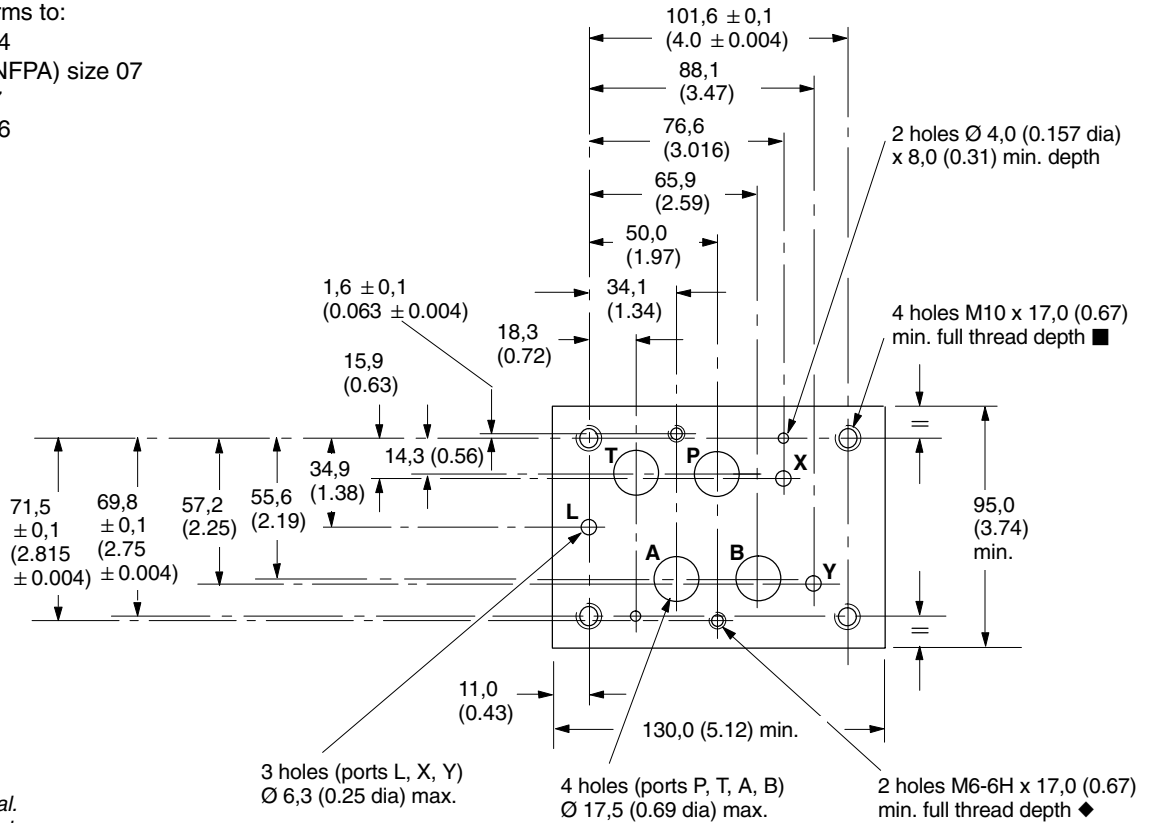

- n $\frac{3}{8}$ " -16 UNC optional.
- ◆ $\frac{1}{4}$ " -20 UNC optional.

Vickers Standard Size 08 Interface

This interface conforms to:

- ISO 4401-08-07-0-94
- ANSI/B93.7M (and NFPA) size 08
- CETOP R35H4.3-08
- DIN 24340 Form A25

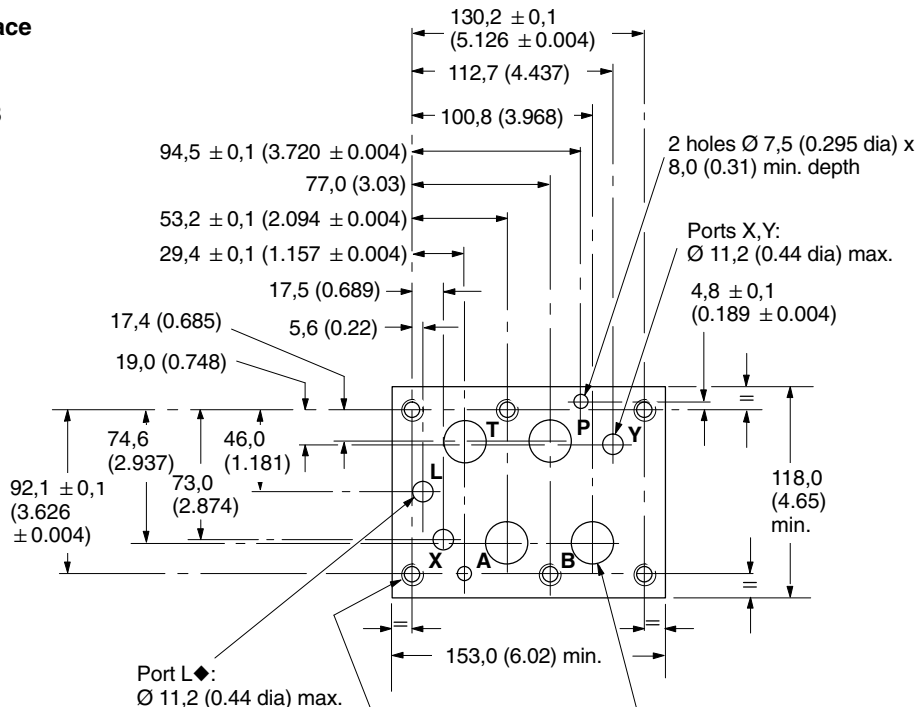

- $\frac{1}{2}$ " -13 UNC optional.
- ◆ Vickers uses port L for pressure-centered and other options not in high demand.

Installation Dimensions in mm (inches) (Sizes 07 and 08)

For up to 350 bar (5000 psi) Maximum Pressure
EDGVM-7Y-D-1*-R (BSPF port threads; metric mounting bolts)
EDGVM-7Z-D-1*-S (UNF/SAE port threads; UNC mounting bolts)

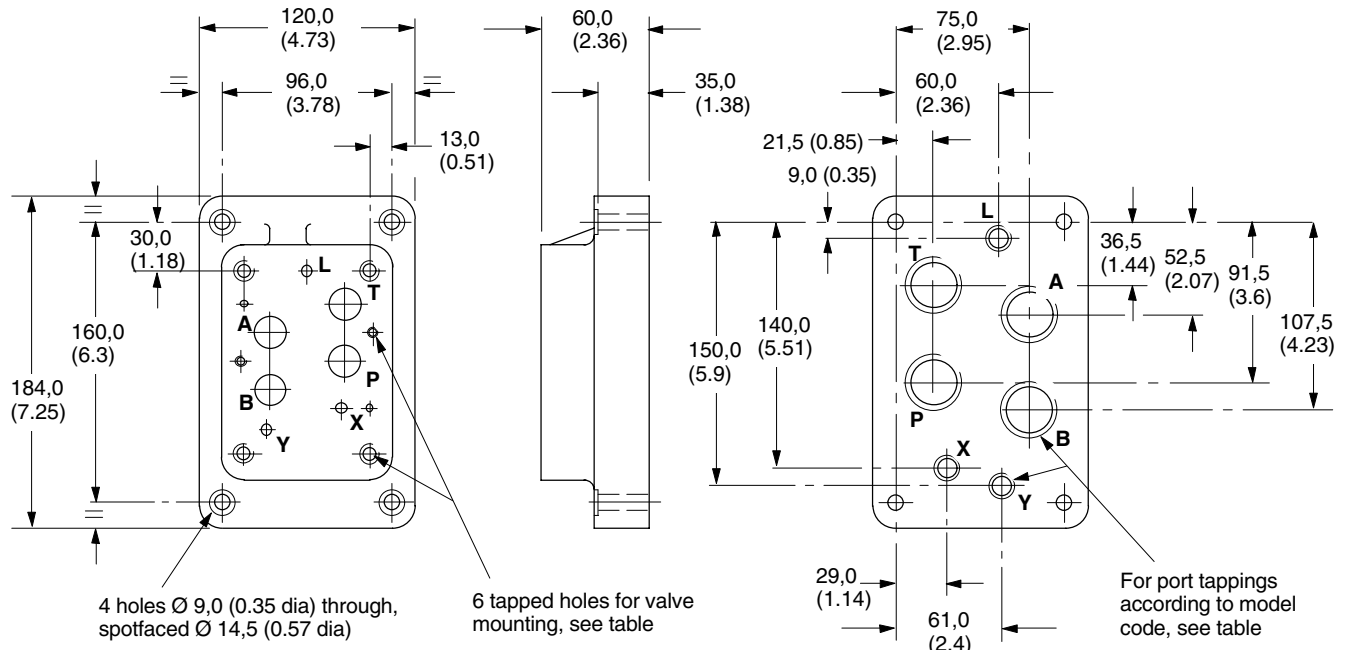
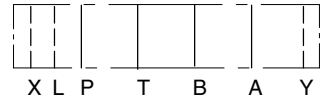

Port and Bolt Threads

Model	Ports P, T, A, B	Ports L, X, Y	Mounting bolt tapping
EDGVM-7Y-D-1*-R	G1 (1" BSPF) x 19,0 (0.75) full thread depth	G ¹ / ₄ (1/4" BSPF) x 12,0 (0.47) full thread depth	4 x M10 2 x M6
EDGVM-7Z-D-1*-S	1 ⁵ / ₁₆ "-12 UN-2B x 19,0 (0.75) full thread depth	9/ ₁₆ "-18 UNF-2B x 12,7 (0.5) full thread depth	4 x 3/ ₈ "-16 UNC 2 x 1/4"-20 UNC

Installation Dimensions in mm (inches) (Sizes 07 and 08)

For up to 210 bar (3000 psi) Maximum Pressure
DGSM-04-12S-2* (UNF/SAE port threads; UNC mounting bolts)

For up to 350 bar (5000 psi) Maximum Pressure
EDGVM-7X-D-1*-R (BSPF port threads; metric mounting bolts)

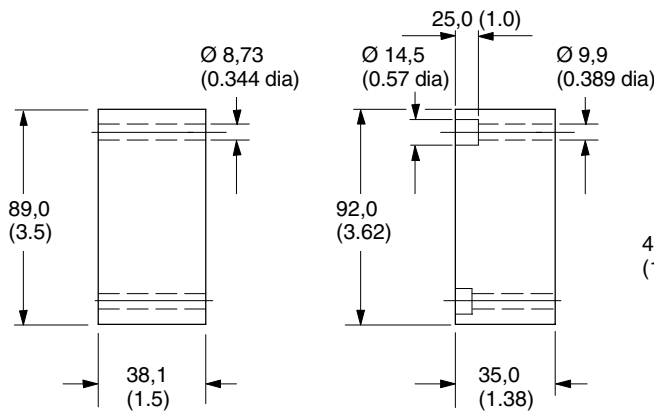
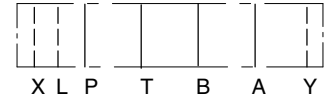

DGSM-04 Only

EDGVM-7X Only

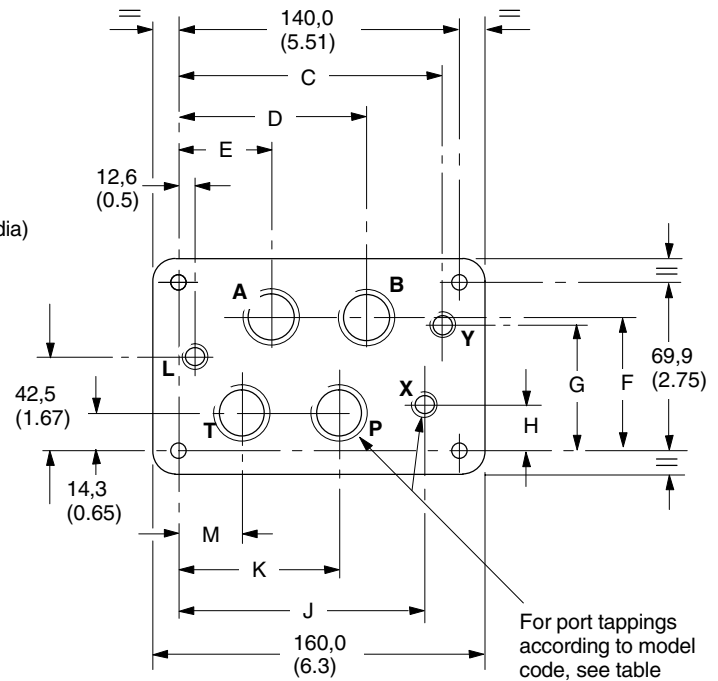

Port and Bolt Threads

Model	Ports P, T, A, B	Ports L, X, Y	Mounting bolt tapping
DGSM-04-12S-2*	1 1/16"-12 UNF-2B x 19,1 (0.75) full thread depth	9/16"-18 UNF-2B x 12,7 (0.5) full thread depth	4 x 3/8"-16 UNC 2 x 1/4"-20 UNC
EDGVM-7X-D-1*-R	G 3/4 (3/4" BSPF) x 16,0 (0.63) full thread depth	G 1/4 (1/4" BSPF) x 12,0 (0.47) full thread depth	4 x M10 2 x M6

Dimensions

Model	C	D	E	F	G	H	J	K	M
DGSM-04-12S-2*	121,4 (4.78)	88,4 (3.48)	44,2 (1.74)	56,6 (2.23)	54,9 (2.16)	18,3 (0.72)	121,4 (4.78)	76,7 (3.02)	32,3 (1.27)
EDGVM-7X-D-1*-R	128,6 (5.06)	93,6 (3.68)	50,6 (1.99)	55,6 (2.19)	52,0 (2.05)	15,9 (0.63)	113,6 (4.47)	79,6 (3.13)	36,6 (1.44)

Installation Dimensions in mm (inches) (Sizes 07 and 08)

For up to 350 bar (5000 psi) Maximum Pressure

Ports P, T, A, B, X, Y

EDGVM-8(*)-1*-R (BSPF port threads; metric mounting bolts)

EDGVM-8Y-1*-S (UNF/SAE port threads; UNC mounting bolts)

Ports P, T, A, B, X, Y and L

EDGVM-8(*)-D-1*-R (BSPF port threads; metric mounting bolts)

EDGVM-8Y-D-1*-S (UNF/SAE port threads; UNC mounting bolts)

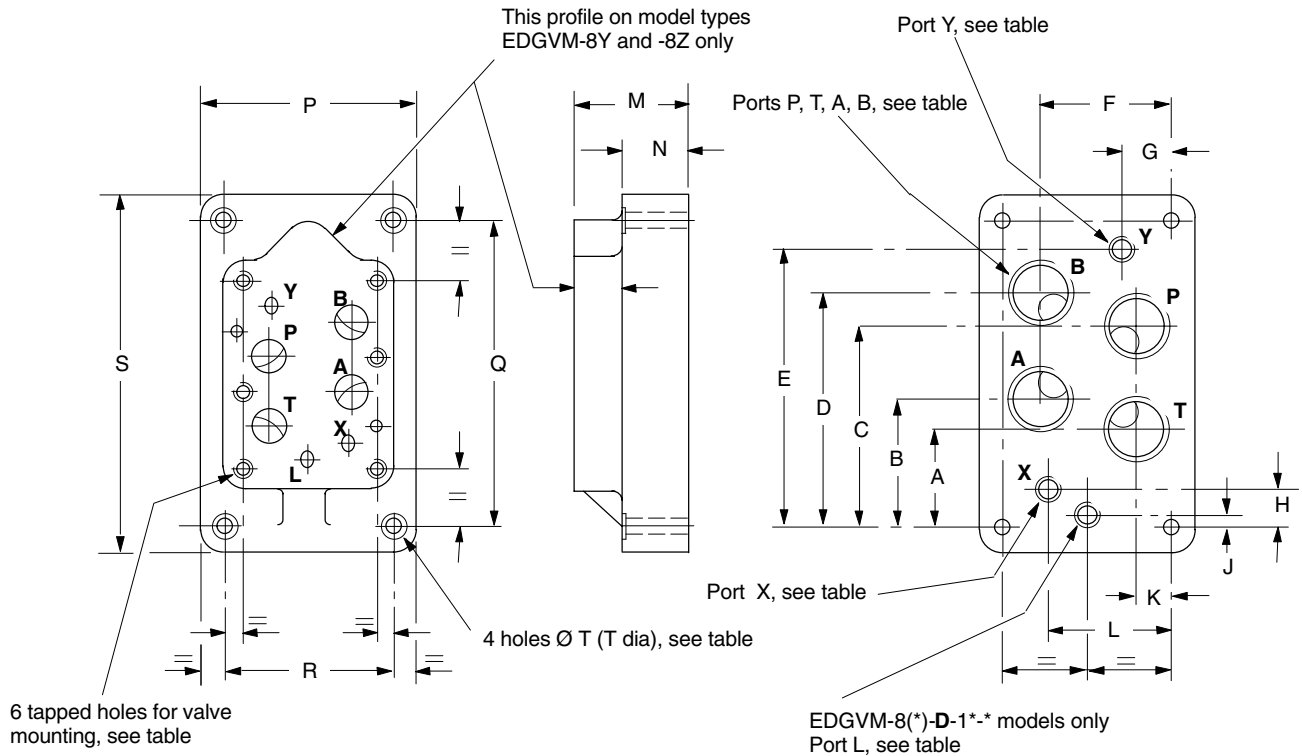
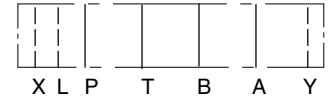

Port Threads, Bolt Tappings and Dimensions

Model	Ports P, A, B, T	Ports L, X, Y	Mounting bolt tappings	A	B	C	D	E	F
EDGVM-8(-D)-1*-R	G ³ / ₄ x 16 (0.63) deep (BSPF)	G ¹ / ₄ x 12,2 (0.48) deep (BSPF)	M12 x 25 (1.0) deep	54,8 (2.16)	78,6 (3.09)	102,4 (4.03)	126,2 (4.97)	160 (6.30)	74,6 (2.94)
EDGVM-8X(-D)-1*-R	G1 x 19 (0.74) deep (BSPF)	G ¹ / ₄ x 12,2 (0.48) deep (BSPF)	M12 x 25 (1.0) deep	49,6 (1.95)	73,4 (2.89)	107,5 (4.23)	131,4 (5.17)	160 (6.30)	74,6 (2.94)
EDGVM-8Y(-D)-1*-R	G ¹ / ₄ x 21 (0.82) deep (BSPF)	G ¹ / ₄ x 12,2 (0.48) deep (BSPF)	M12 x 25 (1.0) deep	50,5 (1.99)	74,2 (2.92)	128,0 (5.04)	151,8 (5.98)	185 (7.28)	103 (4.06)
EDGVM-8Y(-D)-1*-S	1 ⁵ / ₈ "-12 UN x 19,1 (0.75) deep	9/ ₁₆ "-18 UNF x 12,7 (0.5) deep	1/2"-13 UNC-2B	50,5 (1.99)	74,2 (2.92)	128,0 (5.04)	151,8 (5.98)	185 (7.28)	103 (4.06)
EDGVM-8Z(-D)-1*-R	G ¹ / ₂ x 22 (0.86) deep (BSPF)	G ¹ / ₄ x 12,2 (0.48) deep (BSPF)	M12 x 25 (1.0) deep	50,5 (1.99)	74,2 (2.92)	128,0 (5.04)	151,8 (5.98)	185 (7.28)	103 (4.06)

Model	G	H	J	K	L	M	N	P	Q	R	S	ØT
EDGVM-8(-D)-1*-R	19	21	31	17,4	73	-	35	119	181	92,1	204	10,8
EDGVM-8X(-D)-1*-R	(0.75)	(0.83)	(1.22)	(0.685)	(2.87)	-	(1.38)	(4.69)	(7.13)	(3.63)	(8.03)	(0.425)
EDGVM-8Y(-D)-1*-R	33	17,5	5,6	27	97	72	45	160	202	130	232	13,5
EDGVM-8Y(-D)-1*-S	(1.30)	(0.69)	(0.22)	(1.06)	(3.82)	(2.84)	(1.77)	(6.30)	(7.95)	(5.12)	(9.13)	(0.53)
EDGVM-8Z(-D)-1*-R												

Installation Dimensions in mm (inches) (Sizes 07 and 08)

For up to 210 bar (3000 psi) Maximum Pressure
 Ports P, T, A, B, X, Y
 DGSM-8-1*-T** (UNF/SAE ports; UNC mounting bolts)

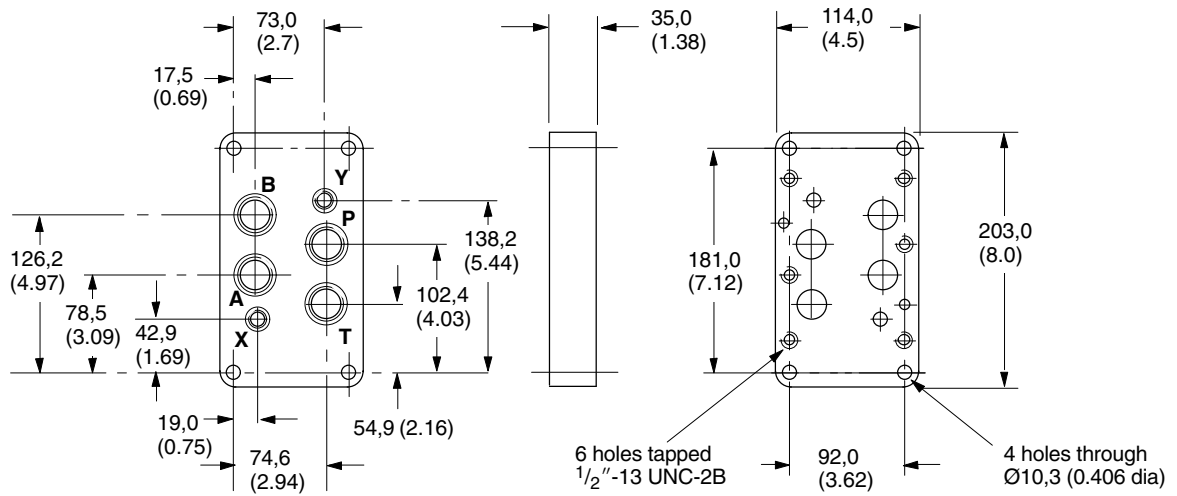
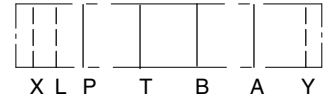

Port Threads

Model	Ports P, T, A, B	Ports X, Y
DGSM-8-1*-T12	1 1/16''-12 UN x 19,1 (0.75) deep	9/16''-18 UNF x 12,7 (0.5) deep
DGSM-8-1*-T16	1 5/16''-12 UN x 19,1 (0.75) deep	9/16''-18 UNF x 12,7 (0.5) deep