

Vickers®

SM4-20 Servo Valves



SM4-20 Servovalves

Flows to 76 l/min (20 USgpm) — Pressures to 210 bar (3000 psi)



Introduction

Vickers SM4-20 servovalves can provide system closed loop control with exact positional accuracy, repeatable velocity profiles, and predictable force or torque regulation.

Typical applications include plastic injection molding and blow molding systems, test and simulation equipment, die casting machines, hydraulic press brakes, animation and entertainment equipment, oil exploration vehicles, and lumber machinery.

This model of the high performance SM4 series offers a wide range of rated flows from 3,8 to 76 l/min (1.0 to 20 USgpm) at Δp of 70 bar (1000 psi).

The SM4 is a two-stage, modular design, flow control valve which can be

manifold or subplate mounted. The symmetrical, dual coil, quad air gap torque motor is integrally mounted to the first stage nozzle flapper pilot valve with six screws. The second stage utilizes a four-way sliding spool and sleeve arrangement with a mechanical null adjust. Spool position is fed back to the first stage by means of a cantilever spring. An integral 35 micron (absolute) filter reduces sensitivity to contamination of the first stage.

An SM4 servovalve, when used with a hydraulic cylinder, position transducer, and appropriate electronics, can provide infinite cylinder position control to within 0,025 mm (0.001 in) or better, depending on the components selected, length of stroke, and load characteristics.

When applied with servo hydraulic motors using tachometer feedback and appropriate electronics, the SM4 provides infinite proportional flow control for real-time velocity/acceleration profiles. The resulting closed loop system can be error corrected to within one-tenth of a revolution per minute. With appropriate pressure transducers or load cells in force control applications, the SM4 makes possible exact load pressure/force control. In addition, excellent system stability with pressure and load to $\pm 1\%$ full scale can be achieved.

The field-proven design of the SM4-20 servovalve, combined with Vickers precision manufacturing techniques, provides you with the optimum in system control.

Features and Benefits

- The wide range of SM4-20 flow capabilities allows selection of the valve size best suited for an application.
- The high strength aluminum alloy of the second stage valve body means lighter weight with rugged durability.
- The symmetrical, dual-coil, quad air gap, dry torque motor, with its extremely fast response to input signals, results in highly accurate control profiles.
- Higher frequency response is available on request to provide enhanced system bandwidth for critical performance requirements.
- An integral 35 micron (absolute) filter provides extra first stage contamination protection.
- The spool and sleeve are hardened stainless steel to minimize wear and erosion. The O-ring mounted sleeve eliminates spool binding and ensures smooth operation.
- Customized spool lap and sleeve porting are available to provide the specific flow control required for special applications.
- The SM4's symmetrical design provides inherently dependable metering of control flow with minimum null shifts. The result is more consistent machine operation.
- Viton* seals are standard.
- The flexibility of a standardized port circle and mounting pattern, with available adapter manifolds, makes Vickers SM4-20 servovalves a cost-effective choice for replacing existing servovalves and enhancing system performance.
- The SM4-20 features a simple interface to an available dual filter module that provides extra protection against pilot stage contamination.
- Flushing valves are available that can greatly reduce initial system contamination levels prior to SM4 installation.

* Viton is a registered trademark of the DuPont Co.

Contents

Operating Data	2
Performance Curves	6
Model Code	10
Installation Dimensions	11
SM4M(E) Mounting Subplates	12
SM4A Adapter Manifolds	15
SM4FV Flushing Valves	17
SM4FM Filter Modules	18
Weights	19
Additional Accessories	19
Application Data	20

Cross Section of Typical SM4-20 Servo Valve

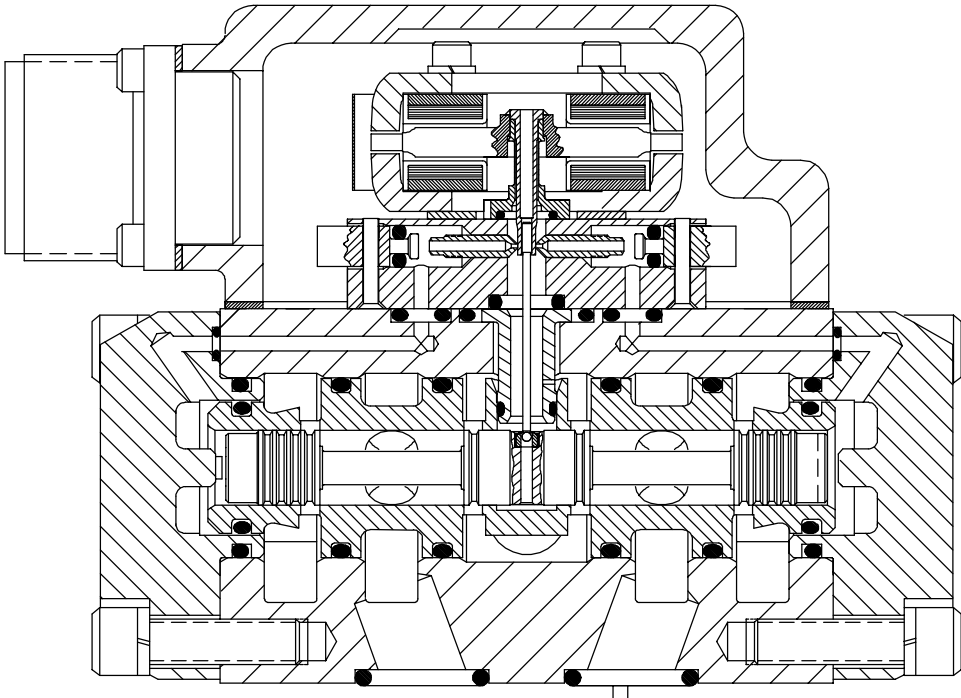

Operating Data

Flow and Leakage

All data is typical, based on actual tests at 70 bar (1000 psi) Δp , 30 cST (141 SUS), and 49°C (120°F).

Model Series	Maximum Rated Flow $\pm 10\%$ l/min (USgpm)	Maximum Total Null Leakage l/min (USgpm)	Maximum Pilot Flow at 70 bar (1000 psi) Δp l/min (USgpm)
SM4-20	76 (20)	2,0 (0.52)	0,35 (0.092)

Performance

Maximum Supply Pressure bar (psi)	SM4-20:	210 (3000)*
Minimum Supply Pressure bar (psi)	14 (200)	
Proof Pressure % maximum supply pressure	At Supply Port: 150 At Return Port: 100	
Burst Pressure, Return Port Open % maximum supply pressure	250	
Maximum Operating Temperature °C (°F)	135 (275)	
Hysteresis Around Null % of rated current	≤ 3	
Symmetry Error % of rated current	< 10	
Linearity Error % of rated current	< 10	
Threshold % of rated current	≤ 0.5	

* SM4-20 (-50 design) features maximum supply pressure of 350 bar (5000 psi). See publication 662 for details.

Ruggedness Test Results

Vibration Test 5 Hz to 2000 Hz along each axis	No damage to components
Shock Test Up to 150g along all axes	No damage to components
Endurance Test To ISO 6404	No degradation in performance

Flow Gain

Normal region for standard models shown with typical no-load flow gain tolerances excluding hysteresis.

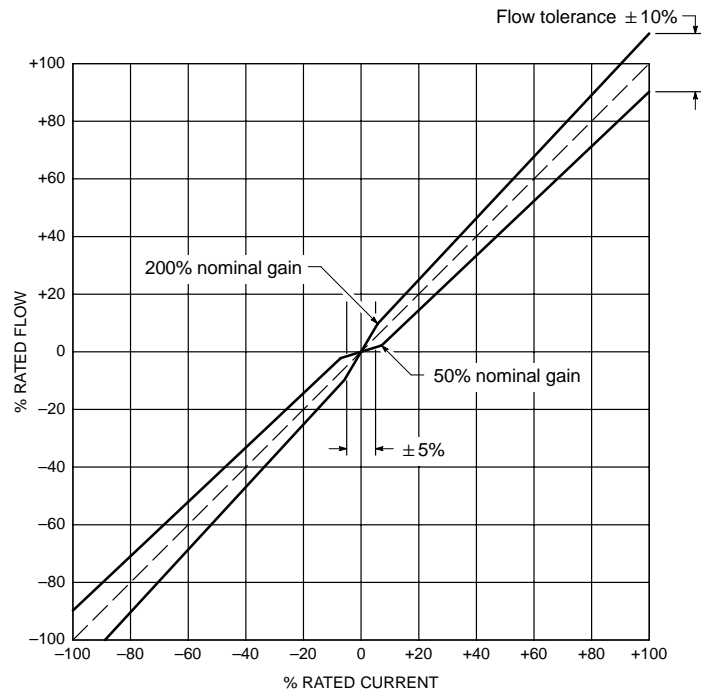

Pressure Gain

Change in load pressure drop with input current shown with no valve flow and closed control ports.

Pressure gain in the null region is $>30\%$ of supply pressure per 1% of rated current.

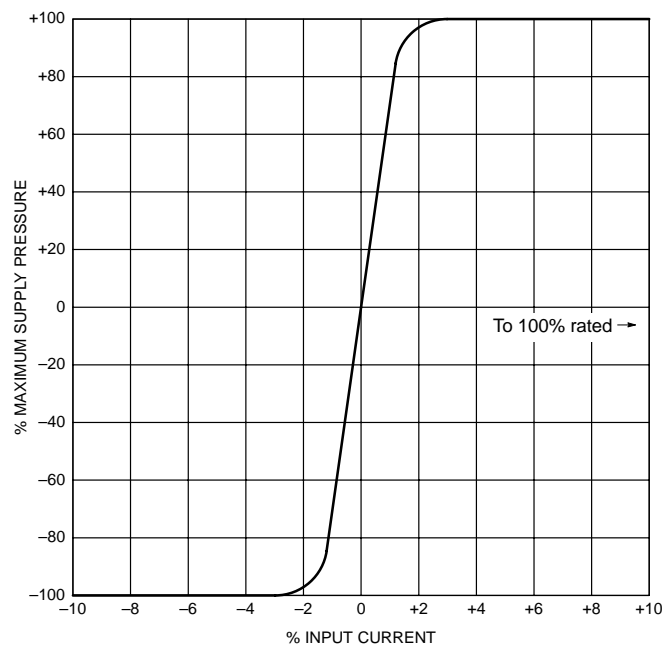

Change in Rated Flow

Rated flows at valve pressure drops from 5 bar (70 psi) to 210 bar (3000 psi) for eight of the available spools.

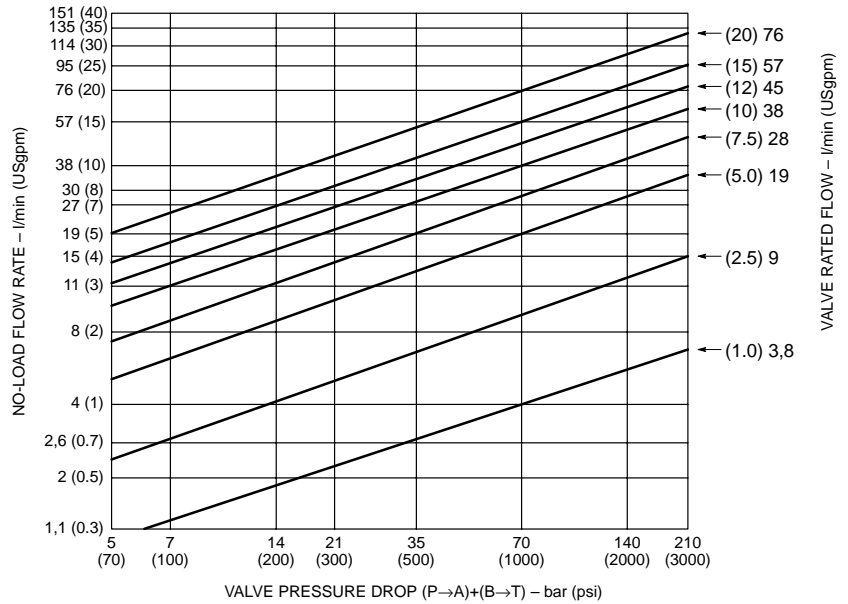

Power Transmission Efficiency

Maximum power envelope expressed as a percentage with T port pressure equal to 0 bar.

Power transferred to the load is optimum when valve pressure drop is one third of supply pressure. Load pressure drop should be limited to $\frac{2}{3}$ of supply pressure so the flow gain of the servovalve remains high enough to maintain control of the load. Overall hydraulic efficiency must be considered when sizing system heat exchangers.

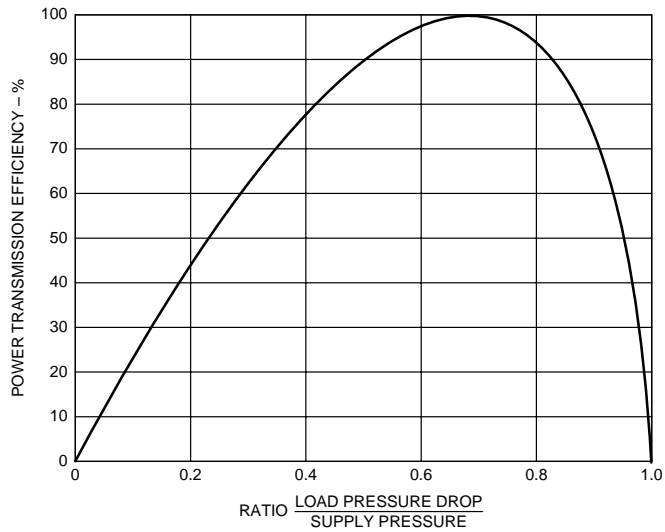

Coil Resistance

Select coil resistance and connections for compatible interface to servo electronics. **Recommended coil resistance is shown in bold print.**

	Nominal Resistance Per Coil at 21°C (70°F) Ohms	Rated Current mA	
		Single, Parallel, or Differential Connection	Series Connection
Standard coil resistance selection	20	200	100
	30	100	50
	80	40	20
	200	20	10
Optional coil resistance selection	80	50	25
	140	40	20
	200	15	7.5
	300	30	15
	1000	10	5
	1500	8	4

Electrical Polarity for Control Flow Out of B Port

Single:

A+, B-
or
C+, D-

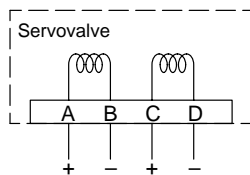

Parallel:

A+, C+
B-, D-
Connect A and C
Connect B and D

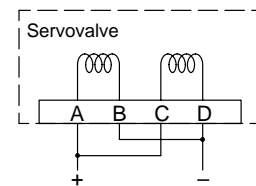

Series:

A+, D-
Connect B and C

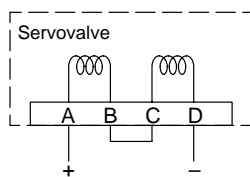

Differential:

A-, D-
B+, C+
Connect B and C
BC-, current BA>CD
BC+, current CD>BA

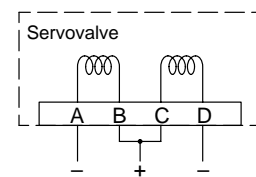

Performance Curves

Frequency Response

Frequency response is defined as the relationship of no-load control flow to input current with a sinusoidal current sweep at constant amplitude over a range of frequencies. It is expressed in frequency (Hz), amplitude ratio (dB), and phase angle (degrees).

As shown in the sample curve (below left), standard comparison points for servovalve frequency response are those frequencies at which -3 dB amplitude ratio and 90° phase angle occur.

Vickers SM4 torque motors are magnetically stabilized for reliable servovalve performance at operating pressures from 14 to 210 bar (200 to 3000 psi).

Calculating Frequency Response at System Pressure

P_S = System pressure

P_M = Maximum supply pressure of valve: 210 bar (3000 psi) for SM4-20 (-10 design)

f_{PM} = Frequency (at 90° phase angle) at maximum supply pressure (P_M)

f_{PS} = Frequency (at 90° phase angle) at system pressure (P_S)

1. Calculate the ratio of system pressure to maximum supply pressure:

$$\frac{P_S}{P_M}$$

2. Use the result of step 1 and the curve below to estimate

$$\frac{f_{PS}}{f_{PM}}$$

3. Use the applicable frequency response curve from page 7 to estimate f_{PM} (the maximum supply pressure frequency response at 90° phase angle) for the desired valve rated flow.

4. Multiply the values obtained in steps 2 and 3. The result is f_{PS} (system pressure frequency response at 90° phase angle).

Example: A standard performance SM4-20 valve with a flow of 38 l/min (10 USgpm) is to be used at 165 bar (2400 psi).

1. Calculate the ratio of system pressure to maximum supply pressure:

$$\frac{P_S}{P_M} = \frac{2400 \text{ psi}}{3000 \text{ psi}} = 0.8$$

2. Use the result of step 1 and the curve below right to estimate

$$\frac{f_{PS}}{f_{PM}} = 0.92$$

3. Use the frequency response curve from page 7 to estimate f_{PM} .

$$f_{PM} = 100 \text{ Hz}$$

4. Multiply the values obtained in steps 2 and 3. The result is f_{PS} (system pressure frequency response at 90° phase angle).

$$f_{PS} = 0.92 \times 100 \text{ Hz} = 92 \text{ Hz}$$

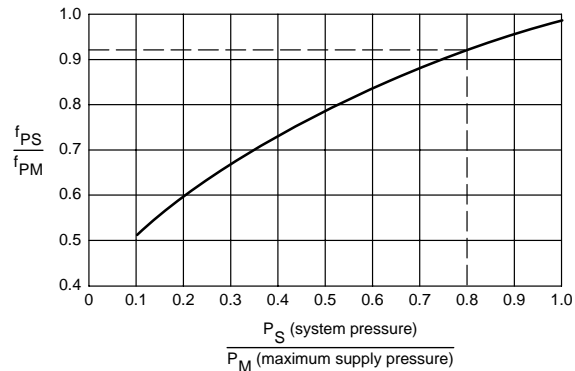
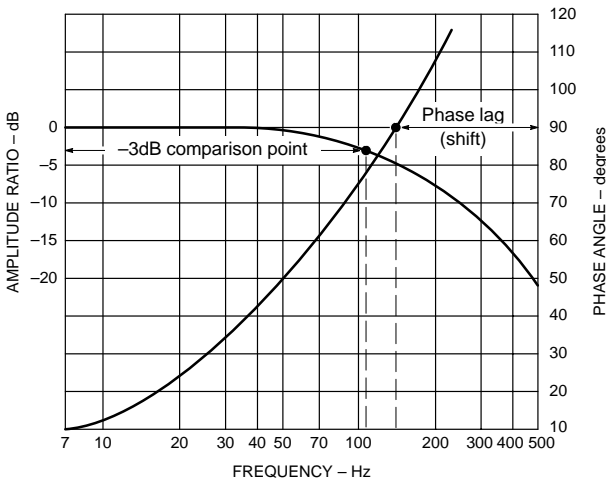

Typical Frequency Response Curves

SM4-20 (-10 design) shown at 210 bar (3000 psi)

3,8 l/min (1.0 USgpm)

9 l/min (2.5 USgpm)

19 l/min (5.0 USgpm)

28 l/min (7.5 USgpm)

— ±40% rated current
 - - - ±100% rated current

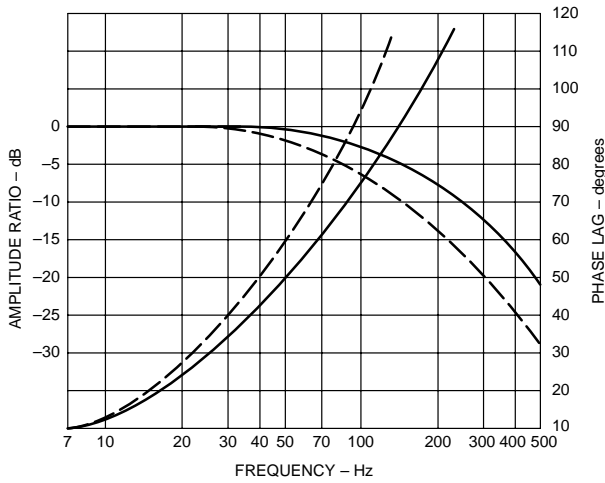

38 l/min (10 USgpm)

— ±40% rated current
 - - - ±100% rated current

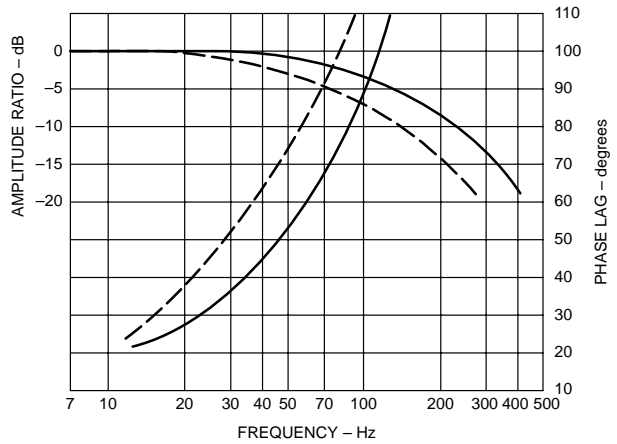

47 l/min (12.5 USgpm)

— ±40% rated current
 - - - ±100% rated current

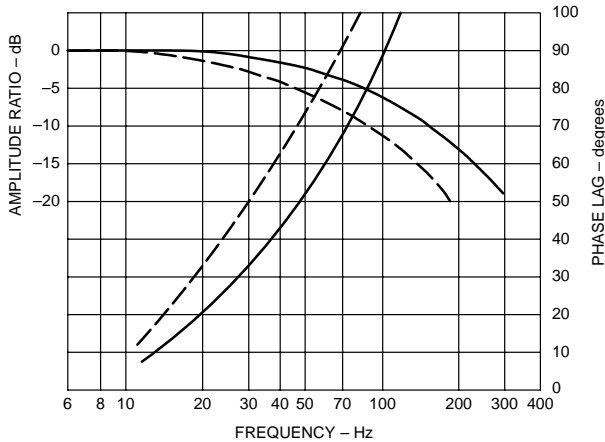

57 l/min (15 USgpm)

76 l/min (20 USgpm)

— ±40% rated current
 - - - ±100% rated current

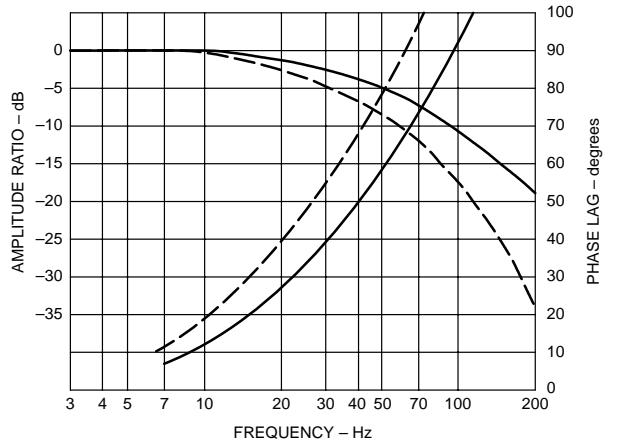

Step Response

Step response is defined as the typical rise time needed to achieve a given percentage of control flow output. Settling time is the time needed for transient flow fluctuations to diminish to within a given accuracy range. Both are expressed in milliseconds (ms).

The example at right shows the step response curves for a critically damped valve and an underdamped valve. Rise times are illustrated for 63% of control flow output, and settling times are shown at $100 \pm 5\%$ of control flow output.

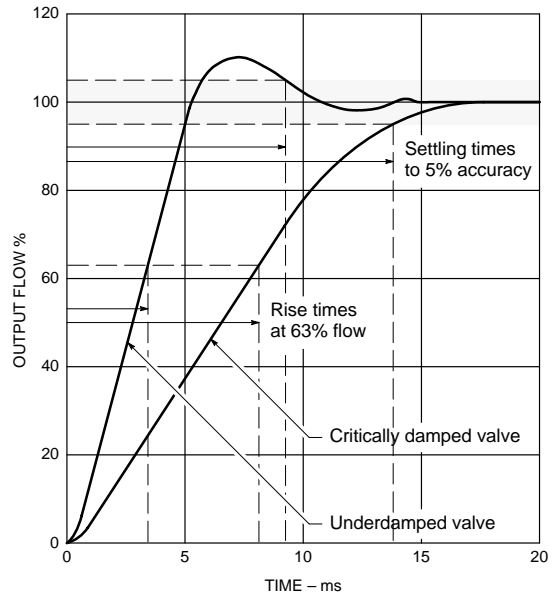

Typical Step Response Curves for Standard Models

SM4-20 shown at 210 bar (3000 psi)

3,8 l/min (1.0 USgpm)
 9 l/min (2.5 USgpm)
 19 l/min (5.0 USgpm)
 28 l/min (7.5 USgpm)

38 l/min (10 USgpm)

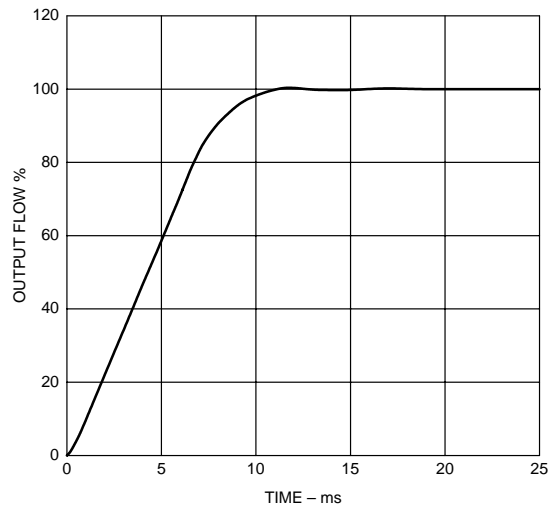
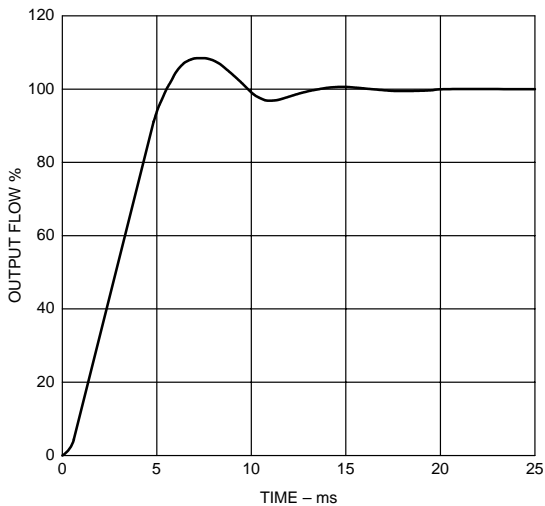

47 l/min (12.5 USgpm)
57 l/min (15 USgpm)

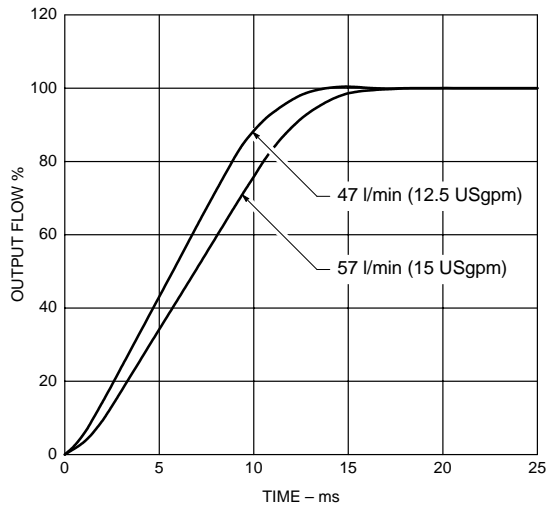

76 l/min (20 USgpm)

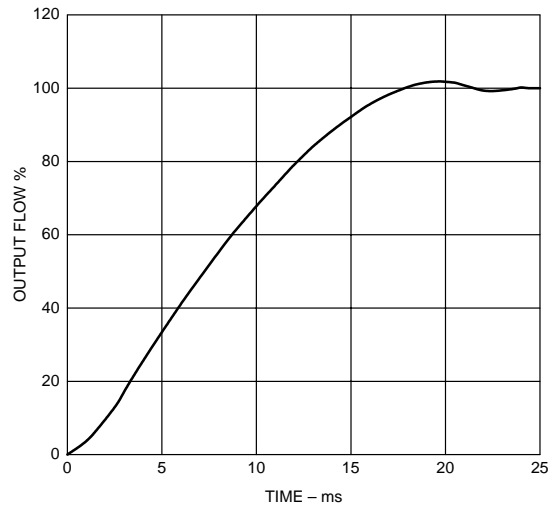

Model Code

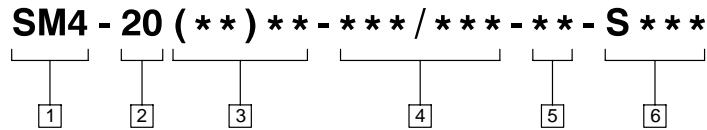

1 Series designation

SM4 – Servovalve, high performance, four-way

2 Valve size

20 – 22,2 mm (0.875 in) port circle

3 Flow rating

At 70 bar (1000 psi) Δp P→A→B→T.
Other flows available on request.

Code	USgpm	l/min
(1) 3,8	1.0	3,8
(2.5) 9	2.5	9
(5) 19	5.0	19
(7.5) 28	7.5	28
(10) 38	10.0	38
(12) 45	12.0	45
(12.5) 47	12.5	47
(15) 57	15.0	57
(20) 76	20.0	76

4 Coil resistance/rated current

Ohms/mA at 21°C (70°F). Other coils available on request.

Code	Ohms	mA
20/200	20	200
30/100	30	100
80/40	80	40
80/50	80	50
140/40	140	40
200/15	200	15
200/20	200	20
300/30	300	30
1000/10	1000	10
1500/8	1500	8

5 Design number

Subject to change. Installation dimensions same for designs 10 through 19.

6 Special features suffix

S81 – Intrinsically safe valve. Contact your Vickers representative for details.

S*** – Vickers assigns a unique suffix to denote a particular group of special features. Contact your Vickers representative for details.

Blank – Standard valve

Installation Dimensions

millimeters (inches)

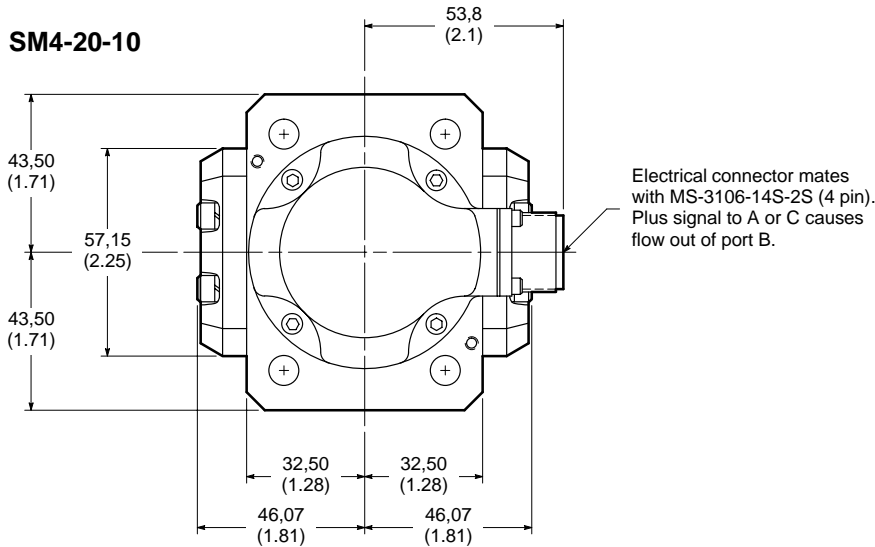

NOTES

Torque mounting screws to 14 to 15 Nm (120 to 130 lb.in.).

Valve mounting surface requires 32 microinch finish flat within 0,025 (0.001).

Viton port O-rings (AS568-013) provided: 1,78 (0.070) cross section and 10,82 (0.426) inner diameter. Replacement O-rings available in seal kit 920320 only.

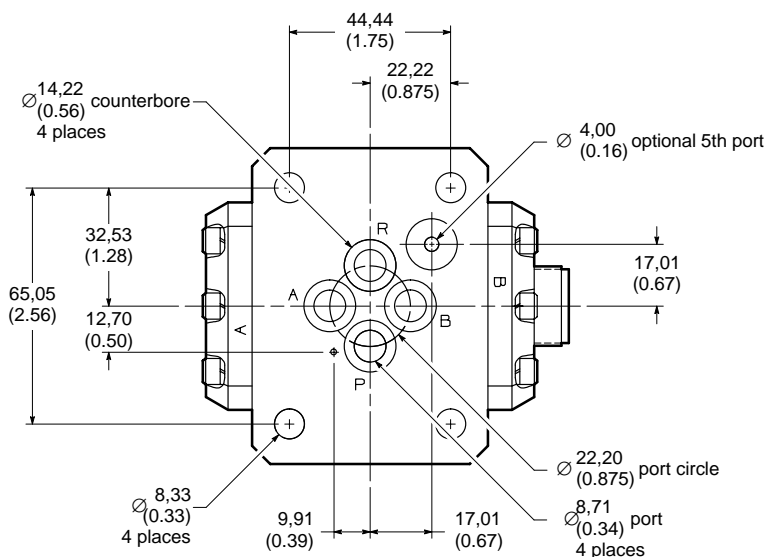
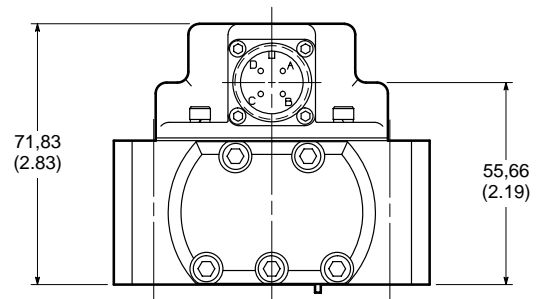
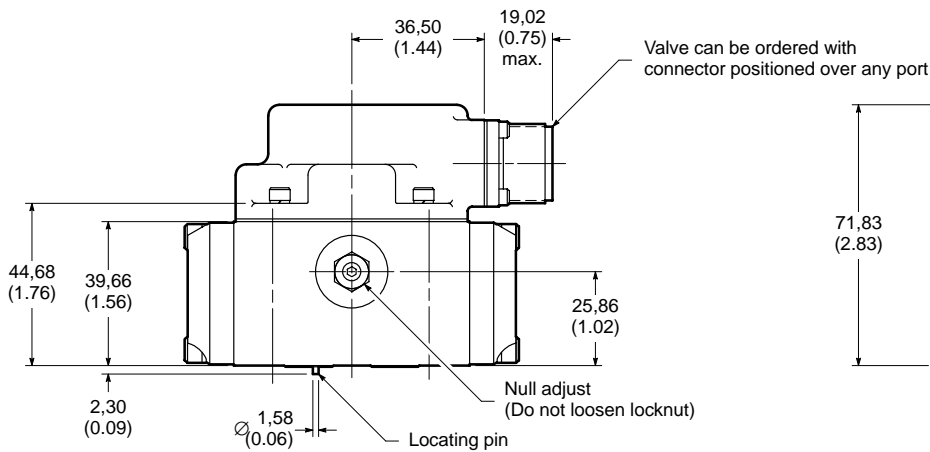

SM4M(E) Mounting Subplates

Model Code

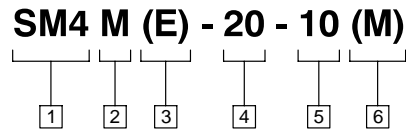

1 Series designation

SM4 – Servovalve, high performance, four-way

3 Port connection locations

Blank – Rear ports
E – Side ports

5 Design number

Subject to change. Installation dimensions same for designs 10 through 19.

2 Accessory designation

M – Mounting subplate. Maximum supply pressure of 210 bar (3000 psi).

4 Standard SM4 valve size

20 – SM4-20 or SP4-25

-10 design indicates 210 bar (3000 psi) maximum supply pressure.

6 Metric suffix

M – Metric version to NG (ISO) standards
Blank – Omit if not required

Installation Dimensions

millimeters (inches)

SM4M-20-10(M)

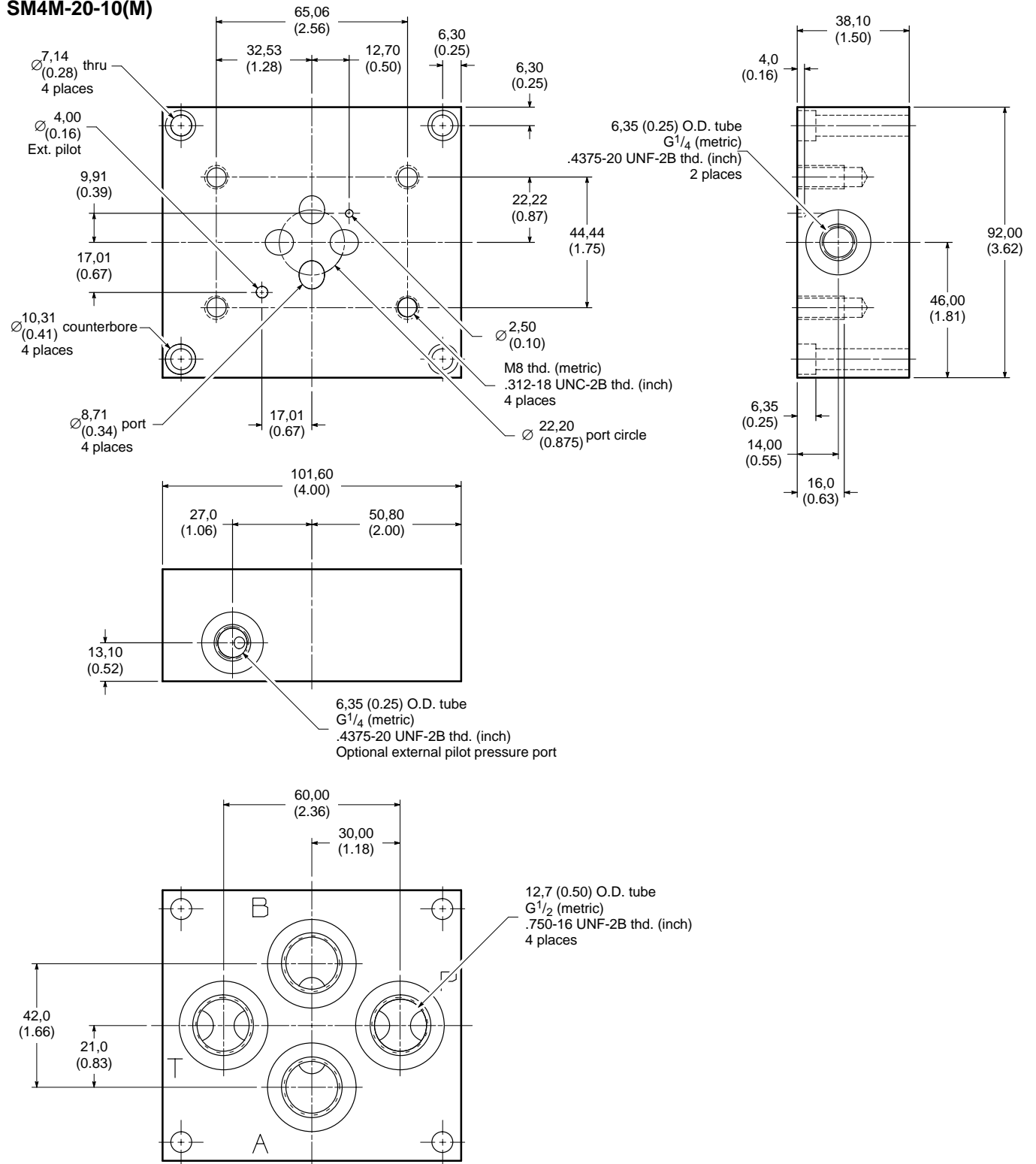

SM4ME-20-10(M)

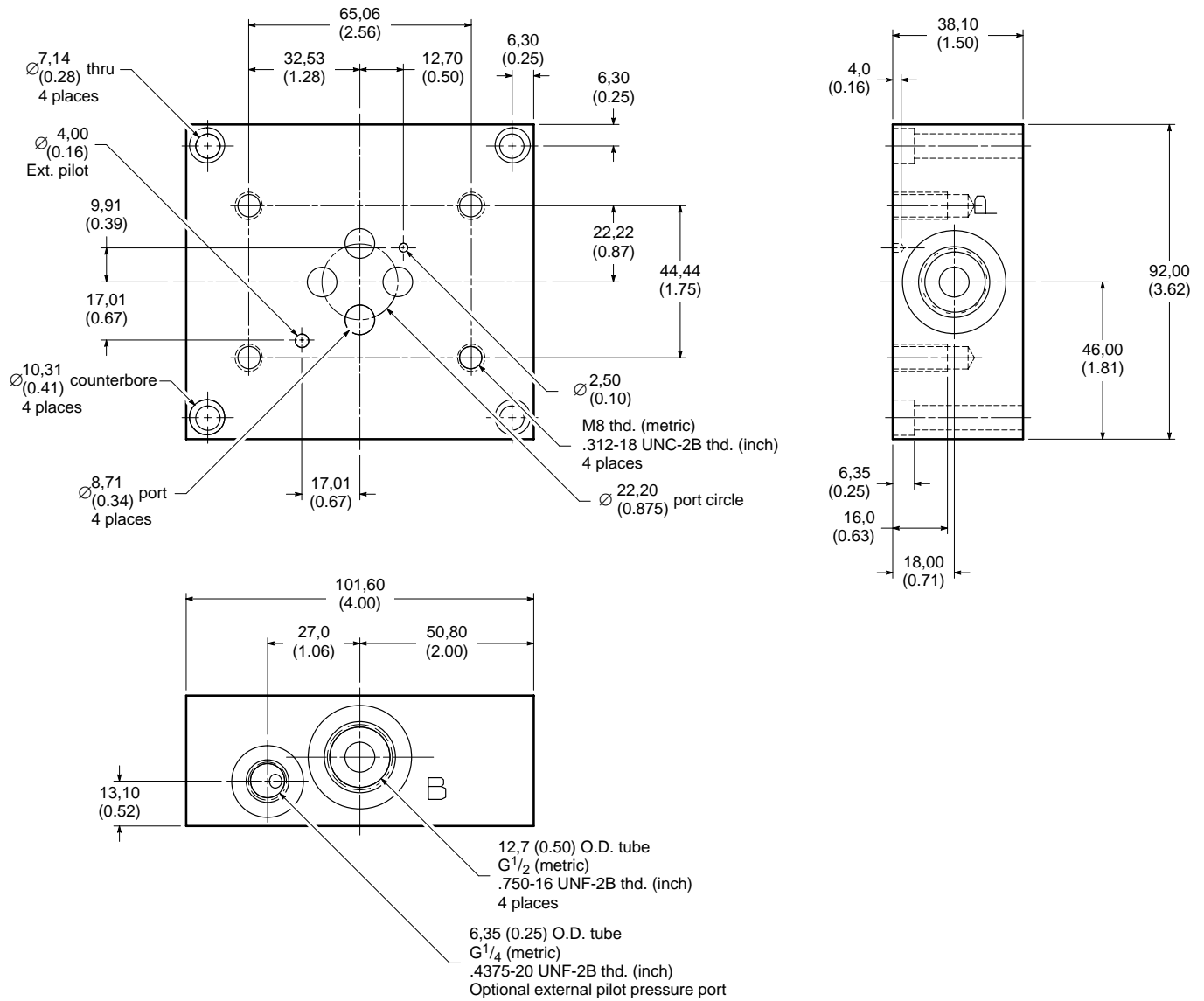

SM4A Adapter Manifolds

Model Code

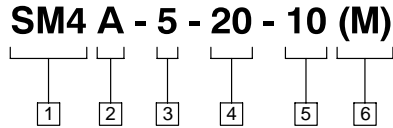

1 Series designation

SM4 – Servovalve, high performance, four-way

2 Accessory designation

A – Adapter manifold. Maximum supply pressure of 210 bar (3000 psi).

3 Interface

5 – ISO 4401-05

4 Standard SM4 valve size

20 – SM4-20 or SP4-25

5 Design number

Subject to change. Installation dimensions same for designs 10 through 19.

-10 design indicates 210 bar (3000 psi) maximum supply pressure.

6 Metric suffix

M – Metric version to NG (ISO) standards

Blank – Omit if not required

Installation Dimensions

millimeters (inches)

SM4A-5-20-10(M)

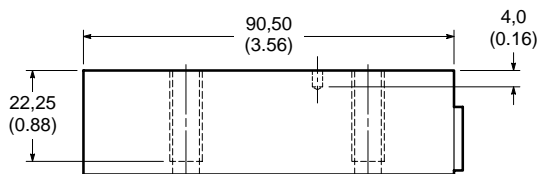
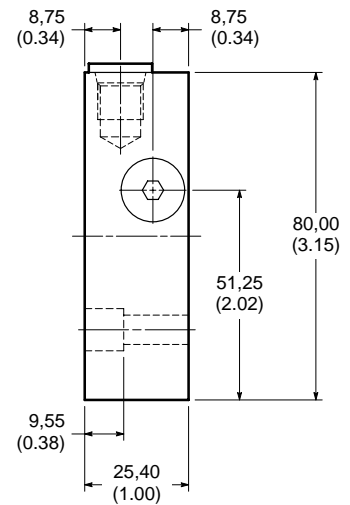
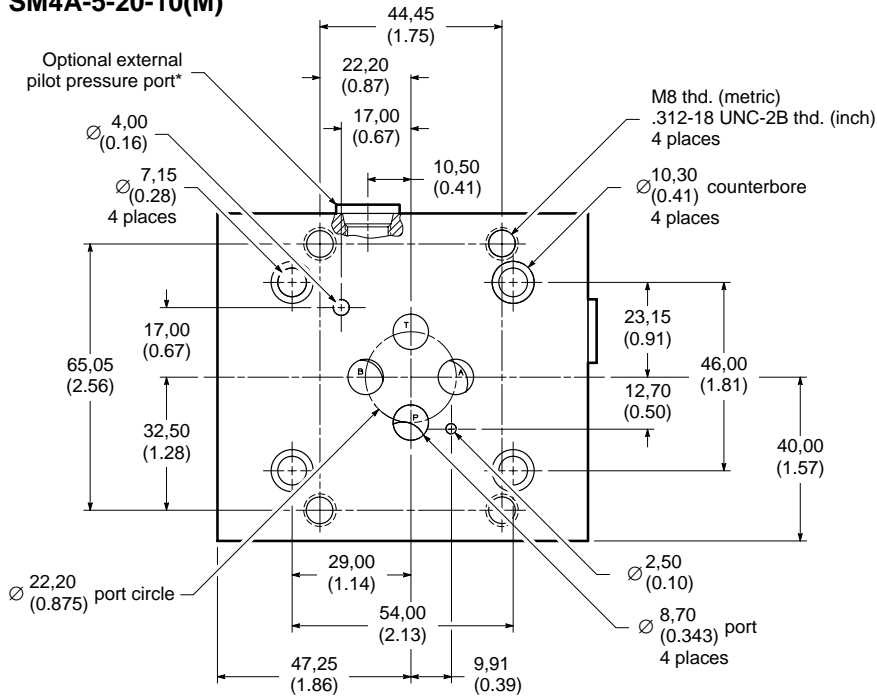

* - 6,35 (0.25) O.D. tube
G¹/₄ (metric)
.4375-20 UNF-2B thd. (inch)

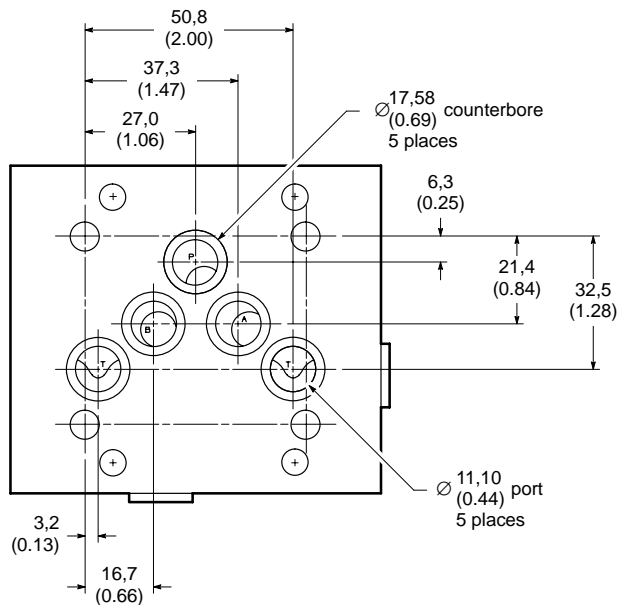

SM4FV Flushing Valves

Model Code

SM4 FV - 20 - 10

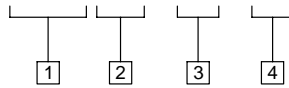

1 Series designation

SM4 – Servovalve, high performance, four-way

2 Accessory designation

FV – Flushing valve. Maximum flushing pressure of 35 bar (500 psi).

4 Design number

Subject to change. Installation dimensions same for designs 10 through 19.

3 Standard SM4 valve size

20 – SM4-20 or SP4-25

Installation Dimensions

millimeters (inches)

SM4FV-20-10

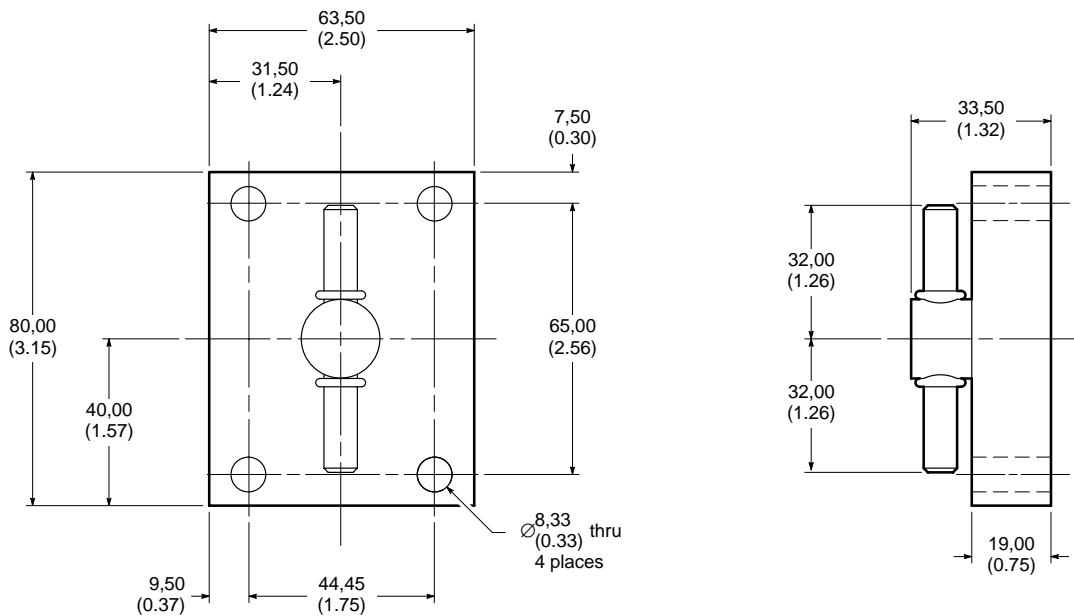

Weights

The following table lists approximate dry weights for SM4 servovalves and related accessories.

Description	Model Code	Weight kg (lbs.)
Servovalve	SM4-20	1,05 (2.3)
Mounting subplate	SM4M(E)-20-10(M)	0,91 (2.0)
Adapter manifold	SM4A-5-20-10(M)	0,439 (0.97)
Flushing valve	SM4FV-20-10(M)	0,27 (0.58)
Filter module	SM4FM-20-(CB)-10	0,73 (1.6) est.

Additional Accessories

SM4-20 (-10 design) Accessories	Model Code
Adapter manifold mounting bolt kit (inch) $1/4-20 \times 1"$	BK866686
Adapter manifold mounting bolt kit (metric) M6 x 25mm	BK689629M
Cable clamp (MS3057-6)	126058
Cable connector (MS3106-14S-2S)	242123
Connector kit	926467
Cross-port bleed module mounting bolt kit (inch) $5/16-18 \times 2^{3/4}"$	BK855421
Filter kit	926469
Filter module kit	886819
Filter module mounting bolt kit (inch) $5/16-18 \times 2^{3/4}"$	BK855421
Filter module mounting bolt kit (metric) M8 x 70mm	BK689624M
Filter module with cross-port bleed mounting bolt kit (inch) $5/16-18 \times 3^{1/4}"$	BK927736
Flushing valve mounting bolt kit (inch) $5/16-18 \times 1^{1/4}"$	BK688701
Flushing valve mounting bolt kit (metric) M8 x 35mm	BK689630M
Seal kit (SM4-20)	920320
Subplate mounting bolt kit (inch) $1/4-20 \times 1^{1/2}"$	BK855992
Subplate mounting bolt kit (metric) M6 x 40mm	BK855993M
Valve mounting bolt kit (inch) $5/16-18 \times 2"$	BK866687
Valve mounting bolt kit (metric) M8 x 50mm	BK866690M

Servo Electronics

See application brochure 656 for the complete Vickers line of amplifiers, power supplies, and function modules.

Application Data

Fluid Cleanliness

Proper fluid condition is essential for long and satisfactory life of hydraulic components and systems. Hydraulic fluid must have the correct balance of cleanliness, materials, and additives for protection against wear of components, elevated viscosity and inclusion of air.

Essential information on the correct methods for treating hydraulic fluid is included in Vickers publication 561 "Vickers Guide to Systemic Contamination Control," available from your local Vickers distributor or by contacting Vickers, Incorporated. Recommendations on filtration and the

selection of products to control fluid condition are included in 561.

Recommended cleanliness levels, using petroleum oil under common conditions, are based on the highest fluid pressure levels in the system and are coded in the chart below. Fluids other than petroleum, severe service cycles, or temperature extremes are cause for adjustment of these cleanliness codes. See Vickers publication 561 for exact details.

Vickers products, as any components, will operate with apparent satisfaction in fluids with higher cleanliness codes than those described. Other manufacturers

will often recommend levels above those specified. Experience has shown, however, that life of any hydraulic component is shortened in fluids with higher cleanliness codes than those listed below. These codes have been proven to provide a long, trouble-free service life for the products shown, regardless of the manufacturer.

NOTE

Vickers will extend, by one year, the standard warranty on all Vickers products used in a system protected by Vickers filters (and elements) applied in a manner consistent with the principles presented in Vickers publication 561.

Product	System Pressure Level bar (psi)		
	<70 (<2000)	70–207 (2000–3000)	207+ (3000+)
Vane pumps, fixed	20/18/15	19/17/14	18/16/13
Vane pumps, variable	18/16/14	17/15/13	
Piston pumps, fixed	19/17/15	18/16/14	17/15/13
Piston pumps, variable	18/16/14	17/15/13	16/14/12
Directional valves	20/18/15	20/18/15	19/17/14
Proportional valves	17/15/12	17/15/12	15/13/11
Servo valves	16/14/11	16/14/11	15/13/10
Pressure/Flow controls	19/17/14	19/17/14	19/17/14
Cylinders	20/18/15	20/18/15	20/18/15
Vane motors	20/18/15	19/17/14	18/16/13
Axial piston motors	19/17/14	18/16/13	17/15/12

Eaton Hydraulics

15151 Highway 5
Eden Prairie, MN 55344
Telephone: 612 937-7254
Fax: 612 937-7130
www.eatonhydraulics.com

46 New Lane, Havant
Hampshire PO9 2NB
England
Telephone: (44) 170-548-6451
Fax: (44) 170-548-7110

